

# RBI

Est. 1919

## Professional Arborist Supplies

EDITION 2 | [www.rbi.com](http://www.rbi.com)

Climber: Nicholas W. Dankers  
Photo by stephengorman.com



# Trust. Feel. Climb.



ArborMaster® Hawkeye™

**samson**®

***THE STRONGEST NAME IN CLIMBING***

[SamsonRope.com](http://SamsonRope.com)



<b>ANSI standards</b> .....	4	<b>cutting + pruning</b> .....	195
<b>stocking kits</b> .....	5	pole saws.....	196
<b>personal protective equipment</b> .....	9	handsaws .....	207
helmets + accessories .....	10	hand pruners.....	213
safety glasses.....	22	other cutting tools.....	217
safety gloves.....	29	<b>rigging</b> .....	219
hearing.....	33	blocks.....	220
safety clothing.....	39	slings.....	223
outerwear, first aid, + education .....	43	rigging rings .....	227
<b>rope</b> .....	53	chains .....	228
climbing lines.....	56	pulleys.....	229
rigging lines.....	70	carabiners.....	232
prusiks.....	78	rigging devices.....	235
rope accessories .....	83	<b>bucket tools + accessories</b> .....	241
<b>storage</b> .....	87	fall arrest harnesses .....	242
rope + gear bags .....	88	fall arrest lanyards .....	245
throwline storage .....	97	bucket covers.....	247
<b>harnesses</b> .....	99	utility scabbards.....	248
positioning.....	101	tools .....	250
accessories.....	115	pads + mats.....	251
fall arrest + utility.....	123	<b>forestry</b> .....	253
fall arrest lanyards .....	126	chains .....	254
<b>climbing</b> .....	127	bars .....	258
throw weights, lines, and kits .....	128	accessories.....	264
friction management.....	132	spark plugs .....	267
carabiners.....	135	fuel .....	268
snaps .....	146	chain grinders.....	274
swivels + pulleys.....	148	<b>cabling + bracing</b> .....	277
lanyards.....	152	cable.....	278
prusiks + split tails.....	162	cabling supplies + accessories.....	279
mechanicals.....	168	hardware + bracing.....	280
ascenders.....	174	thimbles, washers, nuts.....	281
basal anchors .....	177	wire stops .....	282
descenders.....	178	wood boring bits.....	284
climbers + spikes .....	181	earth anchors .....	285

**NOTE** Not all items offered are shown in catalog, please call for assistance.



# ANSI standards

## A NOTE ABOUT ANSI STANDARDS

ANSI standards are a set of safety standards developed by the American National Standards Institute (ANSI). These standards are developed with a consensus of accredited standard developers, and are designed to protect industry professionals by providing a safety threshold for various devices and equipment. The items listed in this catalog list ANSI compliance whenever available.

It is important to note that knowledge of OSHA standards and their compliance is the responsibility of the operator. It is also the operator's responsibility to understand the relationship between OSHA and ANSI. The standards provided on this page are for reference only.

Please visit [www.ansi.org](http://www.ansi.org) for the most recent ANSI standard updates.

### GENERAL SCOPE

This standard contains **arboriculture** safety requirements for pruning, repairing, maintaining, and removing trees; cutting brush; and for using equipment in such operations.

### GENERAL PURPOSE

The purpose of this standard is to provide safety standard for **arborists** and other workers engaged in arboricultural operations. It is intended as a guide to federal, state, and local authorities in drafting their regulations and may be adopted in whole or in part.

#### ANSI Z133.1-2017 (8.2.4)

Arborist climbing lines used for **moving rope systems** shall have a minimum diameter of 1/2" (12.7 mm) and be constructed from a synthetic fiber, with a minimum breaking strength of 5,400 pounds (24.02 **kilonewtons** [kN]) without termination when new. Maximum working elongation shall not exceed 7 percent at a load of 540 pounds (2.402 kN). Arborist climbing lines shall be identified by the manufacturer as suitable for tree climbing.

**EXCEPTION** - In arboricultural operations not subject to regulations that supersede Z133, a line of not less than 7/16" (11 mm) diameter may be used, provided the employer can demonstrate it does not create a safety hazard for the arborist and the arborist has been instructed in its use. The line selected shall meet or exceed the standards for arborist climbing lines and shall be identified by the manufacturer as suitable for tree climbing.

© International Society of Arboriculture. Used with permission.

#### ANSI Z133.1-2017 (8.2.8)

Carabiners used as a part of a climber's work-positioning (suspension) system shall be self-closing and self-double-locking and shall have a gate-locking mechanism that requires at least two consecutive, deliberate actions to unlock. A carabiner shall be capable of withstanding a 5,000 pound (22.24-kN) load along its major axis with the gate closed without breaking or distortion sufficient to release the gate.

© International Society of Arboriculture. Used with permission.

#### ANSI Z133.1-2017 (8.2.7)

Snap hooks (rope snaps) used as a part of a climber's work-positioning (suspension) system shall be self-closing and self-locking, with a minimum tensile strength of 5,000 pounds (22.24 kN).

© International Society of Arboriculture. Used with permission.

#### ANSI Z133.1-2017 (8.1.4)

While working aloft, the climber shall have available a climbing line and at least one other means of being secured on his/her person at all times (example: an arborist climbing line and a work-positioning lanyard). Two means of being secured shall be used when the arborist determines that it is advantageous.

© International Society of Arboriculture. Used with permission.

#### ANSI Z133.1-2017 (8.1.3)

Arborist(s) shall inspect climbing lines, **worklines (line, workline)**, work-positioning lanyards, and other climbing equipment for damages, cuts, abrasion, and/or deterioration before each use and shall remove them from service, per manufacturers guidelines if applicable if signs of excessive wear or damage are found. Climbing lines or worklines that are removed from service may be used for other noncritical purposes if deemed suitable for such use by a qualified person.

© International Society of Arboriculture. Used with permission.

## WARNING

The products in this catalog are intended for use by trained professional personnel in the tree care industry. Use of these products by individuals not properly trained may result in serious injury or possible death.

The producers of this catalog are not responsible for the use or misuse of any of the products in this catalog.

All products are provided for use by professionally trained individuals with complete knowledge of their use and application.



# stocking kits

## Level 1 - Arborist Intro Kit

Convenient starter kit contains the gear you need to get started in the arborist business.

\*SILKY products not available for distribution in the Florida market, please reference model number (-FL).

SKU	PRODUCT
INTROKIT	Arborist Intro Kit
INTROKIT-FL	Arborist Intro Kit in Florida



WEAVER COUGAR WLC-700 SADDLE [MEDIUM & LARGE]



SAMSON TRUE-BLUE



SPYDER ALUMINUM CLIMBERS W/ T PADS



WEAVER 12 OZ THROW BAG CORDURA

### KIT CONTAINS:

Climbing Helmet	1 Kask Super Plasma	Lime	
	1 Kask Super Plasma	Yellow	
Climbing Harness	1 Weaver Cougar Harness - WLC-700	Medium	
	1 Weaver Cougar Harness - WLC-700	Large	
Climbing Line	1 Pelican Arborist Climbing Line - 1/2"   13 mm	150'	
	1 Teufelberger Safety Blue Hi-Vee - 1/2"   12.7 mm	150'	
	1 Samson True Blue - 1/2"   12 mm	150'	
Rope Bag - Climbing	2 Weaver Basic Rope Bag	Blue	
Climbing Hardware	2 Rock Exotica Rock-O Carabiners		
	2 Rock Exotica Pirate Auto-Lock Carabiner		
	2 Rock Exotica Rock-O Wire Eye Auto-Lock Carabiner		
	2 Rock Exotica Pirate Wire Eye Auto-Lock Carabiner		
	2 Kong XL Rescue Steel Carabiner		
	2 Kong XL Rescue Steel Twist Lock Carabiner		
	2 Kong XL Aluminum Carabiner		
	2 Safety Snap With Fixed Eye		
	2 DMM UltraO Carabiners		
	2 DMM Hitch Climber Pulley		
	Lanyards	1 Adjustable Double Braid Safety Lanyard	
		1 Samson Blue Streak USR Snap Kit	10'
2 Spyder Prusik 3/8"		32"	
Throwline	2 Gibbs Micrograb	7/16-1/2"	
	3 Samson Zing-it 1.75		
Throwballs	3 Samson Zing-it 2.2		
	3 Weaver Throw weight	12oz	
Throwline Storage	3 Weaver Throw weight	14oz	
	2 Weaver Throwcube		
Accessory Webbing	2 Weaver Webbing Loop	36"	
	2 Weaver Webbing Loop	24"	
Climbers	1 Spyder Aluminum Climbers w/ T Pads		
Rigging Line	1 Samson Stable Braid 1/2	150'	
	1 Samson Stable Braid 5/8	150'	
Rope Bag- Rigging	2 Weaver Basic Rope Bag	Red	
Port-a-wrap	1 BUCK Port-a-wrap 601L	Large	
Whoopie Sling	1 Samson Whoopie Sling 3/4	3.5'-14'	
Chainsaw Bungee	2 Weaver Chainsaw Bungee Lanyard		
Hand pruners	1 Spyder Phoenix Hand Pruners		
	1 Weaver Pruner Pouch w Clip		
Handsaw	1 ARS 32 PRO Handsaw		
	1 ARS 32 Handsaw		
	1 Silky ZÜBAT 330"		



WEAVER CHAINSAW BUNGEE LANYARD RING-TO-RING



# arborist dealer stocking kits

## Level 2 – Arborist Standard Kit

Convenient climber kit packed with even more items than our arborist starter kit.

\*SILKY products not available for distribution in the Florida market, please reference model number (-FL).

SKU	PRODUCT
STANDARDKIT	Arborist Standard Kit
STANDARDKIT-FL	Arborist Standard Kit in Florida



KASK SUPER PLASMA [LIME]



TEUFELBERGER TREEMOTION EVO



TEUFELBERGER SAFETY BLUE ULTRA-VEE - 1/2" | 12.7 MM



Samson Blue Streak  
USR Snap Kit

### KIT CONTAINS:

Climbing Helmet	1 Kask Super Plasma	Lime
	1 Kask Super Plasma	Yellow
Climbing Harness	1 Teufelberger TreeMotion EVO	One Size
	1 Edelrid TreeRex	1
	1 Weaver Cougar Harness	Medium
	1 Weaver Cougar Harness	Large
Climbing Line	1 Pelican Arborist Climbing Line - 1/2"   13 mm	150'
	1 Teufelberger Safety Blue Ultra-Vee - 1/2"   12.7 mm	150'
	1 Teufelberger Safety Blue Hi-Vee - 1/2"   12.7 mm	150'
	1 Samson True-Blue - 1/2"   12 mm	150'
	1 Samson Arbor-Plex - 1/2"   12 mm	150'
Rope Bag – Climbing	2 Weaver Basic Rope Bag	Blue
Climbing Hardware	2 DMM Ultra Range Carabiners	
	1 DMM UltraO Carabiners	
	2 Rock Exotica Rock-O Carabiners	
	3 Rock Exotica Pirate Auto-Lock Carabiner	
	3 Rock Exotica Rock-O Wire Eye Auto-Lock Carabiner	
	3 Rock Exotica Pirate Wire Eye Auto-Lock Carabiner	
	3 Kong XL Rescue Steel Carabiner	
	3 Kong XL Rescue Steel Twist Lock Carabiner	
	3 Kong XL Aluminum Carabiner	
	3 Kong Asymmetric Carabiner with Bar	
	3 Kong Ovalone Aluminum Triple Lock Carabiner	
	2 DMM Hitch Climber Pulley	
	Lanyards	1 Adjustable Double Braid Safety Lanyard
1 Samson Blue Streak USR Snap Kit		10'
2 Spyder Prusik 3/8"		32"
	2 Gibbs Micrograb	7/16-1/2"
Climbers	1 Spyder Alum Climbers w/ T Pads	
	1 Spyder Alum Climbers w/ Ultra Pad	
Throwline	2 Teufelberger Dynaglide Orange	200'
	2 Samson Zing-It 1.75mm	180'
Throwballs	2 Weaver Throw Weights	14oz
	2 Weaver Throw Weights	16oz
Throwline Storage	2 Weaver Throwcube	
Rigging Line	1 Samson Stable Braid 1/2	150'
	1 Samson Stable Braid 5/8	150'
	1 Sirius Rigging Line 14mm (orange)	150'
Rope Bag – Rigging	2 Weaver Basic Rope Bag	Red
Port-a-wrap	2 BUCK Port-A-Wrap 601LN	Large
Whoopie Sling	2 Samson Whoopie Sling 3/4	3.5'-14'
Chainsaw Bungee	3 BUCK Bungee Chainsaw Lanyard	
Chainsaw Harness Holder	2 Rock Exotica Transporter	
Handsaw	2 Silky ZÜBAT 330°	
	2 Silky Gomtaro 300°	
	2 ARS 32 PRO Handsaw	
	2 ARS 32 Handsaw	
Gear Bag	1 Weaver Cavern Bag	



ARS 32 PRO 13" CURVED ARBORIST  
SAW WITH SCABBARD



# arborist dealer stocking kits

## Level 3 – Arborist Expanded Kit

The Arborist Expanded Kit contains just about everything you need to get started in the arborist business, all packaged in a low price that will guarantee profit for your business. Develop a loyal customer base by keeping popular arborist products in stock and available.

\*SILKY products not available for distribution in the Florida market, please reference model number (-FL).

SKU	PRODUCT
EXPANDEDKIT	Arborist Expanded Kit
EXPANDEDKIT-FL	Arborist Expanded Kit in Florida



CAMP TREE ACCESS EVO

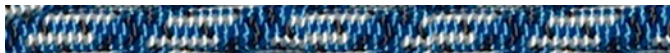

TEUFELBERGER TACHYON FROSTBIGHT – 7/16" | 11.5 MM



ISC ROPE WRENCH WITH TETHER



ROCK EXOTICA AKIMBO



WEAVER CAVERN BAG

Bag only, additional items shown not included.

### KIT CONTAINS:

Climbing Helmet	1 Kask Super Plasma	Lime
	1 Kask Super Plasma	Yellow
Communication Systems	2 Sena TuffTalk - Bluetooth Communication	Single
Climbing Harness	1 Teufelberger TreeMotion EVO	One Size
	1 Edelrid TreeRex	1
	1 Camp Tree Access EVO	1
	1 Weaver Cougar Harness	Medium
	1 Weaver Cougar Harness	Large
Climbing Line	1 Teufelberger Tachyon Frostbight – 7/16"   11.5 mm	150'
	2 Teufelberger Tachyon Ash – 7/16"   11.5 mm	150'
	2 Teufelberger Safety Blue Ultra-Vee – 1/2"   12.7 mm	150'
	2 Teufelberger Safety Blue Hi-Vee – 1/2"   12.7 mm	150'
	2 Samson True-Blue – 1/2"   12 mm	150'
	2 Samson Arbor-Plex – 1/2"   12 mm	150'
	2 Samson Hawkeye – 1/2"   12 mm	150'
Rope Bag – Climbing	2 Weaver Basic Rope Bag	Blue
Climbing Hardware	2 DMM Ultra Range Carabiner	
	1 DMM UltraO Carabiners	
	3 Rock Exotica Rock-O Carabiner	
	3 Rock Exotica Pirate Auto-Lock Carabiner	
	3 Rock Exotica Rock-O Wire Eye Auto-Lock Carabiner	
	3 Rock Exotica Pirate Wire Eye Auto-Lock Carabiner	
	3 Rock Exotica Rock-O Auto-Lock Carabiner	
	3 Rock Exotica Pirate ORCA Lock Carabiner	
	3 Kong XL Rescue Steel Carabiner	
	3 Kong XL Rescue Steel Twist Lock Carabiner	
	3 Kong XL Aluminum Carabiner	
	3 Kong Asymmetric Carabiner with Bar	
	3 Kong Ovalone Aluminum Triple Lock Carabiner	
	3 Kong Ferrara Triple Lock Aluminum Carabiner	
	2 DMM Hitch Climber Pulley	
	2 Spyder Prusik 3/8"	32"
	1 Rock Exotica Akimbo	
	1 ISC Rope Wrench	
	1 CT Foot Ascender	Left
	1 Haas Velox Regular	
1 Weaver Chest Harness		
Lanyards	1 Teufelberger HipStar CE Lanyard	12'
	1 Samson Blue Streak USR Snap Kit	10'
	1 Spyder Steel Core Lanyard Kit	10'
	2 Gibbs Micrograb	7/16-1/2"
Throwline	3 Teufelberger Dynaglide Orange	200'
	3 Samson Zing-It 1.75mm	180'
Throwballs	3 Weaver Throw Weight	14oz
	3 Weaver Throw Weight	16oz
Thowline Storage	2 Weaver Throwcube	
Climbers	1 Spyder Alum Climbers w/ T Pads	
	1 Spyder Alum Climbers w/ Ultra Pad	
Rigging Line	2 Samson Stable Braid 1/2	150'
	2 Samson Stable Braid 5/8	150'
	2 Sirius Rigging Line 14mm (Orange)	150'
Rope Bag – Rigging	2 Weaver Basic Rope Bag	Red
Port-a-wrap	2 BUCK Port-A-Wrap 601LN	Large
Whoopie Sling	2 Samson Whoopie Sling 3/4	3.5'-14'
Chainsaw Bungee	3 BUCK Bungee Chainsaw Lanyard	
Chainsaw Harness Holder	3 Rock Exotica Transporter	
Handsaw	2 Silky ZÜBAT 330°	
	2 Silky Gomtaro 300°	
	2 Silky Sugoi 330°	
	2 Silky GunFighter 330°	
	2 ARS 32 PRO Handsaw	
	2 ARS 32 Handsaw	
Gear Bag	1 Weaver Cavern Bag	



# arborist dealer stocking kits

## Level 4 - Arborist Professional Kit

The Professional kit offers climbers of all ranges the premium gear they need for tree care including some exclusive and brand new gear. The professional kit will elevate your gear to the next level!

\*SILKY products not available for distribution in the Florida market, please reference model number (-FL).

SKU	PRODUCT
PROKIT	Arborist Expanded Kit
PROKIT-FL	Arborist Expanded Kit in Florida



SAMSON VORTEX COOL  
SPLICED (TIGHT EYE ONE END)



SILKY ZÜBAT 330\*



EDELRID TREEREX



EDELRID TALONS



WEAVER SRT CHEST HARNESS

### KIT CONTAINS:

Climbing Helmet	4 Kask Super Plasma	Lime
	4 Kask Super Plasma	Yellow
	4 Kask Super Plasma Visor	Clear
Communication Systems	2 Sena TuffTalk - Bluetooth Communication	Single
Climbing Harness	1 Teufelberger TreeMotion EVO	One Size
	1 Edelrid TreeRex	1
	1 Camp Tree Access EVO	1
	2 Weaver Cougar Harness	Medium
Climbing Line	2 Weaver Cougar Harness	Large
	2 Teufelberger Tachyon Frostbight - 7/16"   11.5 mm	150'
	2 Teufelberger Tachyon Ash - 7/16"   11.5 mm	150'
	3 Teufelberger Safety Blue Ultra-Vee - 1/2"   12.7 mm	150'
	3 Teufelberger Safety Blue Hi-Vee - 1/2"   12.7 mm	150'
	3 Samson True-Blue - 1/2"   12 mm	150'
	2 Samson Arbor-Plex - 1/2"   12 mm	150'
Rope Bag - Climbing	2 Samson Hawkeye - 1/2"   12 mm	150'
	1 Samson Vortex Cool Spliced (tight eye one end)	150'
Rope Bag - Climbing	2 Weaver Basic Rope Bag	Blue
Climbing Hardware	4 DMM Ultra Range Carabiner	
	4 DMM UltraO Carabiners	
	4 Rock Exotica Rock-O Carabiner	
	4 Rock Exotica Pirate Auto-Lock Carabiner	
	4 Rock Exotica Rock-O Wire Eye Auto-Lock Carabiner	
	4 Rock Exotica Pirate Wire Eye Auto-Lock Carabiner	
	4 Rock Exotica Rock-O Auto-Lock Carabiner	
	4 Rock Exotica Pirate ORCA Lock Carabiner	
	4 Kong XL Rescue Steel Carabiner	
	4 Kong XL Rescue Steel Twist Lock Carabiner	
	4 Kong XL Aluminum Carabiner	
	4 Kong Asymmetric Carabiner with Bar	
	4 Kong Ovalone Aluminum Triple Lock Carabiner	
	4 Kong Ferrata Triple Lock Aluminum Carabiner	
	3 Kong Right Hand Ascender	
	4 US Rigging Triple Gate Aluminum Swivel Carabiner	
	3 US Rigging Double Lock Safety Hook	
	3 US Rigging Double Lock Safety Hook Swivel	
	3 US Rigging Double Lock Safety Snap Aluminum	
	4 US Rigging Captive Eye Swivel Carabiner	
	3 CMI Micro Double Pulley	
	3 DMM Hitch Climber Pulley	
	3 DMM Pinto Pulley Red	
	3 Spyder Prusik 3/8"	32"
	1 Rock Exotica Unicender	
	1 Rock Exotica Akimbo	

Climbing Hardware cont.	2 ISC Rope Wrench	
	2 CT Foot Ascender	Left
	3 US Rigging Big 8 Aluminum Descender	
	3 US Rigging Small 8 Aluminum Descender	
	2 Haas Velox Regular	
Lanyards	1 Weaver Chest Harness	
	1 Weaver SRT Chest Harness	
Lanyards	2 Teufelberger HipStar CE Lanyard	12'
	3 Samson Blue Streak USR Snap Kit	10'
	3 Spyder Steel Core Lanyard Kit 1/2"	10'
	3 Spyder Steel Core Lanyard Kit 1/2"	12'
Throwline	3 Gibbs Micrograb	7/16-1/2"
	3 US Rigging FlipLine Kit	12'
Throwballs	6 Teufelberger Dynaglide Orange	200'
	6 Samson Zing-It 1.75mm	180'
Throwballs	8 Weaver Throw Weight	14oz
	8 Weaver Throw Weight	16oz
	4 Weaver Throwline Kit	16oz
Thowline Storage	2 Weaver Throwcube	
Climbers	2 Spyder Alum Climbers w/ T Pads	
	2 Spyder Alum Climbers w/ Ultra Pad	
	1 Edelrid Talons	
Rigging Line	2 Samson Stable Braid 1/2	150'
	2 Samson Stable Braid 5/8	150'
	2 Sirius Rigging Line 14mm (Orange)	150'
Accessory Sling	3 Nylon Loop Runner Blue	24"
	3 Nylon Loop Runner Orange	30"
	3 Nylon Loop Runner Orange	40"
Rope Bag - Rigging	2 Weaver Basic Rope Bag	Red
Port-a-wrap	2 BUCK Port-A-Wrap 601LN	Large
Whoopie Sling	2 Samson Whoopie Sling 3/4	3.5'-14'
Chainsaw Bungee	3 BUCK Bungee Chainsaw Lanyard	
	3 Weaver Chainsaw Bungee Orange	
	3 Edelrid Tool Lanyard	
Chainsaw Harness Holder	3 Rock Exotica Transporter	
Handsaw	3 Silky ZÜBAT 330*	
	3 Silky Gomtaro 300*	
	3 Silky Sugoi 330*	
	3 Silky GunFighter 330*	
	3 ARS 32 PRO Handsaw	
	3 ARS 32 Handsaw	
Gear Bag	2 Weaver Cavern Bag	
Measuring Tape	3 Spencer Forestry Tape	





# 1 | personal protective equipment

HELMETS + ACCESSORIES .....	10
SAFETY GLASSES.....	22
SAFETY GLOVES .....	29
HEARING .....	33
SAFETY CLOTHING .....	39
OUTERWEAR, FIRST AID, + EDUCATION .....	43



# helmets + accessories



## KASK Superplasma PL HI VIZ

### SPECS

**Colors** Red, White, Yellow, Lime

**Weight** 0.93 lbs | 420 g

**Size** Universal adjustable from hat sizes 6<sup>3</sup>/<sub>8</sub> to 7<sup>3</sup>/<sub>4</sub>

**Notes** *Visors are sold separately. Helmet comes with 1 set of helmet muff adapters. Make your own hi-vis helmet by adding the 3M sticker kit to your helmet.*

KASK's Superplasma PL HI VIZ is an innovative, high-visibility helmet, specifically designed for professional work-at-height and work-at-ground application. It is lightweight, compact, comfortable and well ventilated. Equipped with a rapid, simple and efficient headband/size adjustment system with a non-slippery rubberized wheel that is easy to use even when wearing protective gloves.



11.224

### FEATURES

- Outer shell is made of High Density ABS Plastic and designed to withstand significant impact from the above or side.
- Inner shell is made of High Density (HD) Polystyrene and has ducts that allow for natural air flow and heat recycling.
- Inner padding consists of two different pieces (soft PE Polythene headband and disc) that are totally removable and washable.
- Liner is made of the anti-allergic, moisture-absorbent, and odor-resistant fabric.

SKU	PRODUCT
11.223	Superplasma PL Helmet HI VIZ - Red
11.224	Superplasma PL Helmet HI VIZ - Lime
11.221	Superplasma PL Helmet HI VIZ - Yellow
11.201	Superplasma PL Helmet HI VIZ - White



11.223



11.221



11.201

## KASK Superplasma PL

### SPECS

**Colors** White, Red, Orange, Yellow, Black, Blue

**Weight** 0.93 lbs | 420 g

**Size** Universal adjustable from hat sizes 6<sup>3</sup>/<sub>8</sub> to 7<sup>3</sup>/<sub>4</sub>

**Notes** *Visors are sold separately. Helmet comes with 1 set of helmet muff adapters. Make your own hi-vis helmet by adding the 3M sticker kit to your helmet.*

KASK's innovative Superplasma PL helmet has been specifically designed for professional work-at-height and work-at-ground application. It is lightweight, compact, comfortable and well ventilated. The air intakes on the outer shell are equipped with the protective aluminum anti-intrusion grille that prevents entry of debris. Equipped with a rapid, simple and efficient headband/size adjustment system with a non-slippery rubberized wheel that is easy to use even when wearing protective gloves.



### FEATURES

- Outer shell is made of High Density ABS Plastic and designed to withstand significant impact from the above or side.
- Inner shell is made of High Density (HD) Polystyrene and has ducts that allow for natural air flow and heat recycling.
- Inner padding consists of two different pieces (soft PE Polythene headband and disc) that are totally removable and washable.
- Liner is made of the anti-allergic, moisture-absorbent, and odor-resistant fabric.

SKU	PRODUCT
10.201	Superplasma PL Helmet - White
10.204	Superplasma PL Helmet - Red
10.203	Superplasma PL Helmet - Orange
WHE00036.202	Superplasma PL Helmet - Yellow
WHE00010.210 BLK	Superplasma PL Helmet - Black
WHE00036.208	Superplasma PL Helmet - Blue



10.201



10.204



10.203



WHE00036.202



WHE00010.210 BLK



WHE00036.208



## KASK Superplasma Visor Screw Kit



This kit contains all the replacement parts required to fit the **KASK** visor to the for **Superplasma V2** helmet.

SKU	PRODUCT
WAC00005	Superplasma Visor Screw Kit

## KASK Superplasma Mesh Visor



The full facial protection of **KASK's Superplasma Mesh Visor** is compatible with the **KASK Superplasma** and **KASK Superplasma HI VIZ** helmet series. This visor is lightweight, durable, and breathable. Note: Visor Screw Kit is sold separately.

SKU	PRODUCT
WV100006	Superplasma Mesh Visor

## KASK Superplasma V2 Visor



This **Superplasma V2 Visor** is for the **KASK Superplasma** and **KASK Superplasma HI VIZ** helmet series. This visor is made of polycarbonate, is anti-fog and scratch resistant, and has a drip proof upper rubber contour. Visor Screw Kit is included.

SKU	PRODUCT
2.009	Superplasma V2 Visor - Smoke
WV100004.500	Superplasma V2 Visor - Clear
WV100002.055	Superplasma V2 Visor - Mirror

## KASK Superplasma FF Visor



The full facial protection of **KASK's Superplasma FF (Full Face) Visor** shield is impact resistant even at extreme temperatures. This visor is made of polycarbonate, is anti-fog and scratch resistant, and has a drip proof upper rubber contour. Compatible with the Superplasma helmet line. Visor Screw Kit is included.

SKU	PRODUCT
WV100003.009 PLASMA	Superplasma FF Visor - Smoke
WV100003.015 PLASMA	Superplasma FF Visor - Clear
WV100003.055 PLASMA	Superplasma FF Visor - Mirror

## KASK Zenith HI VIZ



### SPECS

- Colors** White, Yellow  
**Weight** 0.95 lbs | 430 g  
**Size** Universal adjustable from hat sizes 6<sup>3</sup>/<sub>8</sub> to 7<sup>3</sup>/<sub>4</sub>  
**NEW** XL - Universal adjustable from hat sizes 7<sup>1</sup>/<sub>4</sub> to 7<sup>7</sup>/<sub>8</sub>  
**Notes** *Visors are sold separately. Helmet fitted with lamp clips, visor attachment points, and earmuff fittings.*

The **KASK Zenith** safety helmet brings a Class E rating (protection from electrical hazards). **KASK's** Up & Down 2.0 adjustment system to give the wearer the perfect fit in width, height, and tilt. High-tech 3D liner fabric that dries very quickly, dispersing moisture to the outside and leaving a fresh feeling for the wearer. Antibacterial treatment that acts as an internal deodorant counteracting the development of unpleasant odors; hygienic function that prevents bacterial proliferation and increases freshness and comfort in the fabric in contact with the wearer's skin. ANSI Z89.1-2014 / CSA Z94.1 / Type 1 Class E

### FEATURES

- Outer shell constructed of durable ABS plastic that is fitted with lamp clips, visor attachment points, and earmuff fittings.
- Inner shell is made of High Density (HD) Polystyrene and has ducts that allow for natural air flow and heat recycling.
- Eco-Leather chinstrap is hypoallergenic and washable to help avoid skin irritation.
- Incomparable level of comfort to help you keep your mind on the job and not your gear.
- Front-end padding is easily removable and washable; developed to provide maximum breathability and optimum moisture absorption.

SKU	PRODUCT
WHE00032.221	Zenith Helmet HI VIZ - Yellow
WHE00032.201	Zenith Helmet HI VIZ - White
WHE000054.224	Zenith Helmet HI VIZ - XL - Lime <b>NEW</b>



WHE00032.221

WHE00032.201

WHE000054.224

## KASK Zenith



### SPECS

- Colors** Black, Orange, Red, White, Yellow, Blue  
**Weight** 0.95 lbs | 430 g  
**Size** Universal adjustable from hat sizes 6<sup>3</sup>/<sub>8</sub> to 7<sup>3</sup>/<sub>4</sub>;  
**NEW** XL - Universal adjustable from hat sizes 7<sup>1</sup>/<sub>4</sub> to 7<sup>7</sup>/<sub>8</sub>  
**Notes** *Visors are sold separately. Helmet fitted with lamp clips, visor attachment points, and earmuff fittings.*

The **KASK Zenith** safety helmet brings a Class E rating (protection from electrical hazards). **KASK's** Up & Down 2.0 adjustment system to give the wearer the perfect fit in width, height, and tilt. High-tech 3D liner fabric that dries very quickly, dispersing moisture to the outside and leaving a fresh feeling for the wearer. Antibacterial treatment that acts as an internal deodorant counteracting the development of unpleasant odors; hygienic function that prevents bacterial proliferation and increases freshness and comfort in the fabric in contact with the wearer's skin. ANSI Z89.1-2014 / CSA Z94.1 / Type 1 Class E

### FEATURES

- Outer shell constructed of durable ABS plastic that is fitted with lamp clips, visor attachment points, and earmuff fittings.
- Inner shell is made of High Density (HD) Polystyrene and has ducts that allow for natural air flow and heat recycling.
- Eco-Leather chinstrap is hypoallergenic and washable to help avoid skin irritation.
- Front-end padding is easily removable and washable; developed to provide maximum breathability and optimum moisture absorption.

SKU	PRODUCT
WHE00031.210	Zenith Helmet - Black
WHE00031.204	Zenith Helmet - Red
WHE00031.201	Zenith Helmet - White
WHE000052.201	Zenith Helmet XL - White <b>NEW</b>
WHE00031.202	Zenith Helmet - Yellow
WHE00031.208	Zenith Helmet - Blue



WHE00031.210

WHE00031.204

WHE00031.201  
XL WHE000052.201

WHE00031.202

WHE00031.208



## KASK Zenith Visor Adapter Clips and Visor Carrier



WAC0009.000



WAC00010

**KASK Zenith Visor Adapter Clips** work with the **KASK Zenith Visor Adapters** and are needed to mount visor or mesh face screens to **KASK Zenith** climbing helmets. Note: Pieces are sold separately.

SKU	PRODUCT
WAC0009.000	Zenith Visor Adapter Clips (includes 2 clips)
WAC00010	Zenith Visor Carrier

## KASK Zenith Carrier Peak



The **KASK Zenith Carrier Peak** is compatible with your **KASK Zenith Full Face/ Mesh Visor Carrier**. Requires the **KASK Zenith Full Face/Mesh Visor Carrier** and **Adapter Clips** for installation.

SKU	PRODUCT
WV100011	Zenith Carrier Peak

## KASK Zenith Visor Kits



WKI00002.015



WKI00002.055

The **KASK Zenith Visor** covers lower on your nose bridge, shields your face from debris, and provides another form of protection for eyes and face. Kits contain a **Zenith Visor** and **Zenith Visor Adapter Clips**.

SKU	PRODUCT
WKI00002.015	Zenith Visor Kit - Clear
WKI00002.055	Zenith Visor Kit - Mirror

## KASK Zenith FF Visor Kits



WKI00003.015



WKI00003.009

The **KASK Zenith FF (Full Face) Visor** shields your whole face from debris and provides another form of protection for eyes. Kits contain a **Zenith Full Face Visor** and **Zenith Visor Adapter Clips**.

SKU	PRODUCT
WKI00003.015	Zenith Full Face Visor Kit - Clear
WKI00003.009	Zenith Full Face Visor Kit - Smoke

## KASK Zenith Visor



WV100007.500



WV100007.055

The **KASK Zenith Visor** covers lower on your nose bridge, shields your face from debris, and provides another form of protection for eyes and face. Please note: Clips are sold separately.

SKU	PRODUCT
WV100007.015	Zenith Visor - Clear
WV100007.055	Zenith Visor - Mirror

## KASK Zenith PM Visor



The **KASK Zenith PM (Plastic Mesh) Helmet Visor** is a full face shield compatible with the **Zenith** helmet line. Lighter than the metal style but shares its 50% light transmission quality. Requires the **KASK Zenith Full Face/Mesh Visor Carrier** and **Adapter Clips** for installation.

SKU	PRODUCT
WV100010	Zenith PM Mesh Helmet Visor

# helmets

PERSONAL PROTECTIVE EQUIPMENT / HELMETS

## KASK Superplasma Reflective Stickers

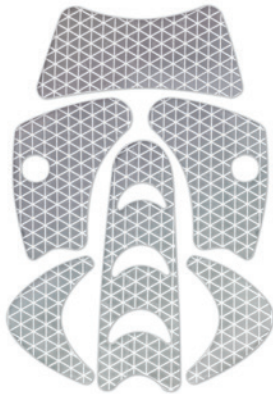

**KASK Superplasma Reflective Stickers** make any helmet hi-visibility. Stickers are pre-cut and offer greater visibility.

SKU	PRODUCT
WAC00001 SUPERPLASMA	Superplasma Reflective Stickers

## KASK Superplasma Helmet Padding



**KASK Superplasma Helmet Replacement Padding** features sweatband and inner crown pieces which attach directly to the helmet for comfort and breathability.

SKU	PRODUCT
WPA00003	Superplasma Helmet Padding

## KASK Zenith Helmet Reflective Stickers



**KASK Zenith Reflective Stickers** make any helmet hi-visibility. Stickers are pre-cut and offer greater visibility.

SKU	PRODUCT
UAC00002	Zenith Helmet Reflective Stickers

## KASK Zenith Helmet Padding



**KASK Zenith Helmet Replacement Padding** is characterized by its excellent material properties. The internal padding provides hygienic protection, comfort, and breathability.

SKU	PRODUCT
WPA0006.000	Zenith Helmet Padding

## KASK Zenith Helmet Neck Shade

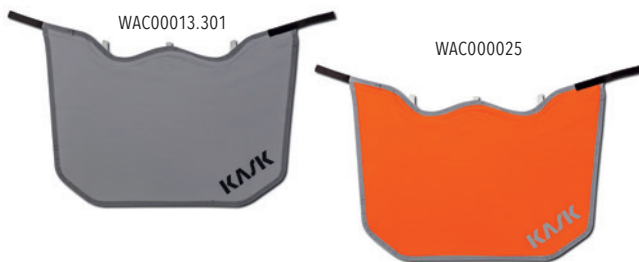

The **KASK Neck Shade** for the **Zenith** helmet series is worn with your helmet to keep your neck protected from harmful UV rays.

SKU	PRODUCT
WAC00013.301	Zenith Helmet Neck Shade - Gray
WAC000025	Zenith Helmet Neck Shade - HI VIZ Orange

## KASK Zenith Extra-Comfort Spacer



The **KASK Zenith Extra-Comfort Spacer** for the **Zenith** helmet series.

SKU	PRODUCT
WPA00008	Zenith Helmet Extra-Comfort Spacer



## KASK Helmet Universal Winter Liner



Fits beautifully under any **KASK** helmet. Features dot cut outs to assist hearing through the liner and tabs on ears designed to slide chin straps through to keep liner from shifting.

SKU	PRODUCT
U00001	Helmet Universal Winter Liner

## KASK Universal Helmet Carrying Bag



ECONOMICAL PROTECTION FOR YOUR HELMET AND ESPECIALLY IF YOU HAVE COMMUNICATION SYSTEMS ON YOUR HELMET

Keep your beloved **KASK** climbing helmet clean, less beat up, and out of the UV rays when not in use. General life spans of helmets are 5-10 years depending on many factors. Reduce your exposure. Features wide opening and drawstring closure.

SKU	PRODUCT
UAC00002	Helmet Carrying Bag

## KASK Helmet Mount Ear Defenders

For long term use in medium noise level or shorter periods in high noise level environments. Best choice in high frequency dominated noise. The Secure helmet mounted earmuff is the ideal choice for any work that requires head and hearing protection. Its durable construction withstands rough environments and the slim design reduces the risk of snagging in branches or confined areas. Available in three protection levels, clearly indicated with bright safety colors for easy identification and selection. "Snap-in" ear cushions with minimal sweat retention and soft foam filling increases the high comfort and are easily replaced.

### SPECS + FEATURES

- Soft cushions maintains a high level of comfort protection
- Color coding for easy selection and identification
- Smooth size adjustment

SKU	PRODUCT
WHP00001.205	Ear Muff KASK Defender Zenith - Green
WHP203:SC3 ORANGE	Ear Muff KASK Defender Zenith - Orange
WHP203:SC2 YELLOW	Ear Muff KASK Defender Zenith - Yellow



WHP00001.205

WHP203:SC3 ORANGE

WHP203:SC2 YELLOW

## KASK Ear Muff Adapter (KASK Bayonet Adapter)

**KASK** Superplasma helmets come with an ear muff adapter; however, if you loose or break one, it's great to have a spare set on hand.

### SPECS + FEATURES

- Fits: all Plasma/Super plasma/HP ear defenders
- Easy installation with a Phillips head screwdriver
- Material: Plastic

SKU	PRODUCT
WAC00003	Ear Muff KASK Helmet Adapter

ADAPTERS FOR SUPERPLASMA HELMETS



# helmets

PERSONAL PROTECTIVE EQUIPMENT / HELMETS

## KONG SPIN Helmet



### SPECS

**Colors** Orange, White, Yellow, Red

**Weight** 0.85 lbs | 385 g

**Size** Universal size

**Notes** *Visors are sold separately. Helmet fitted with built in mounting points for visors and hearing protection.*

### FEATURES

- Conforms to ANSI Z89.1-2009 and CE EN 397.
- New professional shock-absorbing helmet made with ABS.
- Visor and headphones can be mounted using the integrated clasp on the shell.
- Equipped with 4 durable clips for mounting headlamps.

The **SPIN helmet** is perfect for arborists. It is stamped ANSI Z89.1 and EN 357 - meaning it meets both OSHA CFR1910 and ANSI Z133 requirements. The SPIN helmet is lightweight, fully adjustable and well vented for all day comfort. The internal pads are removable for washing.

SKU	PRODUCT
99720A001KK	SPIN Helmet - Orange
99720AW10KK	SPIN Helmet - White
99720AY10KK	SPIN Helmet - Yellow
99720AR10KK	SPIN Helmet - Red



99720A001KK



99720AW10KK



99720AY10KK



99720AR10KK

## KONG SPIN Visors



The **KONG SPIN Helmet visor** is resistant to surface damage caused by fine particles and mist. Made of high-quality polycarbonate of Japanese origin. Extremely robust. The included mounting kit can easily be assembled with **SPIN helmets** thanks to the pre-marked holes in the shell.

SKU	PRODUCT
997056P00KK	SPIN Visor - Clear
997056F00KK	SPIN Visor - Smoked



997056P00KK



997056F00KK



The **Pfanner Protos Helmet** is a must have for me. I've struggled to find a helmet that was both small enough for me and comfortable enough to wear the entire day. The Protos adjusts for a perfect fit and is very comfortable. The fold-away ear protection is convenient and it's great to not snag the muffs on branches. I'll definitely buy again."

– Betsy Parks, Certified Arborist, Parks Tree, OH





## Pfanner Protos® Integral Helmets

### SPECS

- Colors** Vary
- Weight** 5 lbs
- Size** One Size, 54 - 62 cm (21.1 - 24.4 in)
- Standards** Certified to EN397 and EN 12492, ANSI Z87.1
- Life Span** Protos outer shell should be replaced every 5 years. For hygiene and proper maintenance, washing is recommended of the main support pads regularly and replacing them every 2-3 years when used daily.

**Notes** *Includes chinstrap for work aloft; The only arborist helmet offering side and rear impact protection.*

The **Pfanner "Protos Integral System"** can be changed within seconds to be used for construction, forestry, arborist work, or climbing operations. The chin strap, visor, neck protection shell, and ear protection are all integrated and yet at the same time modular items. Thanks to the strongly gripping neck protector, the helmet sits perfectly even while working at an angle or upside-down and gives you a safe hold.

The **Protos** arborist helmet from **Pfanner** is the most advanced helmet system available on the market offering the best energy absorption, lightest weight, and unprecedented breath-ability. The side impact protection sets it apart from its competitors and makes it arguably the safest climbing helmet ever brought to market. **NOTE Protos** helmets are now made with a grey foam insert, **NOT** the green koroyd included with earlier versions of the helmet.

### FEATURES

- Integrated hearing protection with low-profile design (limits getting caught on branches).
- Field of vision is optimized because of the swept back design
- Adjustable pressure fitting of the hearing protectors allows for a perfect fit.
- Even weight distribution design and the adjustable neck piece allow for a perfect, secure and comfortable fit, even without the chin strap.
- Adjustable vent flow on helmet (vents can be opened or closed) allows for use in wet, hot or cold work conditions.
- Features discrete channel for the included chin strap designed to prevent the chin strap from slipping under the ear protector.
- Extraordinary wicking of perspiration via large and exchangeable pads with Klima-AIR technology.
- All functions of the helmet (hearing protection, face shield, helmet adjustment, and helmet vents) can be activated with just two fingers... making operation of the helmet easy.
- Designed over a 15 year period with two things in mind: total head protection and working arborists

SKU	PRODUCT
PROTOS-GRGY	Protos Integral Helmet - Green/Grey
PROTOS-RY	Protos Integral Helmet - Red/Yellow
PROTOS-WG	Protos Integral Helmet - White/Grey
PROTOS-WB	Protos Integral Helmet - White/Black
PROTOS-GW	Protos Integral Helmet - Olive Green/White
PROTOS-BK	Protos Integral Helmet - Black
PROTOS-RDBK	Protos Integral Helmet - Red/Black
PROTOS-YB	Protos Integral Helmet - Yellow/Black
PROTOS-YG	Protos Integral Helmet - Yellow/Grey
PROTOS-ONY	Protos Integral Helmet - Orange/Yellow
PROTOS-ORGR	Protos Integral Helmet - Orange/Grey



PROTOS-WG



PROTOS-WB



PROTOS-YB



PROTOS-GW



PROTOS-BK



PROTOS-GRGY



PROTOS-ORGR



PROTOS-RDBK



PROTOS-YG



PROTOS-RY



PROTOS-ONY

# helmets

PERSONAL PROTECTIVE EQUIPMENT / HELMETS

## Protos Integral Clear Visor

PFANNER



The **Protos Integral Clear Visor** is an extremely lightweight polycarbonate visor. The patented rubber edge on top of the visor prevents liquids, dust, and rain from falling into the helmet. The polycarbonate visor offers a UV protection filter.

SKU	PRODUCT
204071	Protos Visor Plastic

## Protos Visor Fine Mesh Replacement

PFANNER



This facial protective visor with 16 notches is designed to mount perfectly onto the **Protos Integral Helmets**. The **Protos G16** visor has a special coating that blocks reflections from sun, and snow reflections when working in freezing conditions.

SKU	PRODUCT
39777	Protos Visor Fine Mesh Replacement

## Protos Ear Muffs Replacement

PFANNER



21935 GREEN



204067-1-21

These adjustable **Replacement Earmuffs** for the **Protos Integral** helmets offer lightweight protection. Fits underneath the helmet shell, reducing the chance of getting stuck on any ropes or branches.

SKU	PRODUCT
21935 GREEN	Protos Ear Muffs Replacement - Green
204067-1-21	Protos Ear Muffs Replacement - Yellow/Red

## Protos Helmet Replacement Padding

PFANNER



A replacement set of pads for the **Pfanner Protos Integral** made of high-quality Cocona functional fibers. Machine washable at 30°C.

SKU	PRODUCT
204060	Protos Helmet Replacement Padding

## Protos Hygiene Set / Support Pads

PFANNER



Replacement support pads for the **Protos Integral** hearing protection. Comfortable fit and no pressure marks. To maintain optimal sound absorption, the Support Pads should be replaced every 6 months.

SKU	PRODUCT
40491R REPLEAR	Protos Hygiene Set / Support Pads



## Protos Helmet Klima Headband



**Klima Headband** with rail to clip-on made of Cocona functional fibers for high wearing comfort and quick drying. Machine washable at 30°C.

SKU	PRODUCT
204060	Protos Helmet Klima Headband

## Protos Replacement Chin Strap



**Protos Replacement Chin strap** for the Protos Integral Helmet.

SKU	PRODUCT
39777	Protos Replacement Chin Strap

## Elvex ProGuard™ Integrated Logger System Dielectric Non-vented with Nylon Screen



### SPECS

**Color** Orange cap with Black Muffs

**Standards** ANSI S12.6, ANSI S3.19, ANSI Z89.1 requires that safety glasses must be worn even when wearing a face shield or screen, EN1731; Meets Class E, G & C.

**ProGuard Integrated Logger System** non-vented combines three highly-functional components: head, face and hearing protection. Increases on-the-job efficiency, delivers all-day comfort and maximum protection in one unit.

### FEATURES

- Tectra non-vented safety cap with special contours on sides to accommodate cap mount ear muffs.
- Features 6 Point Ratchet hidden head-hugging suspension with nylon webbing for secure fit.
- QuickSnap cap mount ear muffs with 25 dB NRR feature two rest positions: flip-out muffs for short term breaks or flip-up on top of safety cap.
- Durable, lightweight Nylon mesh screen is great for outdoor applications where ventilation is required.



SKU	PRODUCT
CU-30R	Elvex ProGuard Non-vented with Nylon Screen

## Elvex ProGuard™ Integrated Logger System Vented with Steel Screen



### SPECS

**Color** Orange cap with Black Muffs

**Standards** ANSI S12.6, ANSI S3.19, ANSI Z87.1-2010, ANSI Z89.1 requires that safety glasses must be worn even when wearing a face shield or screen. Meets Class G & C.

**ProGuard Integrated Logger System** non-vented combines three highly-functional components: head, face and hearing protection. Increases on-the-job efficiency, delivers all-day comfort and maximum protection in one unit.

### FEATURES

- Tectra vented safety cap with special contours on sides to accommodate cap mount ear muffs.
- Features 6 Point Ratchet hidden head-hugging suspension with nylon webbing for secure fit.
- QuickSnap cap mount ear muffs with 27 dB NRR feature two rest positions: flip-out muffs for short term breaks or flip-up on top of safety cap.
- Steel mesh screen offers impact resistance and is intended to deflect flying objects.



SKU	PRODUCT
CU-60R-V	Elvex ProGuard Vented with Steel Screen

# helmets

PERSONAL PROTECTIVE EQUIPMENT / HELMETS

## OREGON® Professional Safety Helmet

OREGON

### SPECS

**Color** Orange  
**Standards** ANSI Z89.1-2014

The **Oregon Professional Helmet** is a high-impact and scratch resistant ABS helmet with 20 ventilation holes and crown shape for maximum breathability.

### FEATURES

- UV-stabilized helmet shell with rain gutter
- Four-point, easy to adjust harness
- Highly absorbent, removable and washable sweatband
- Anti-slip headband with easy-to-use "pull-push" system for precise snug-fit
- Durable, lightweight stainless steel mesh visor with strong flip-up-and-down function and extended face protection
- Easy up-and-down adjusting earmuff system with optimum, consistent noise attenuation (NRR value 24 dB) and comfortable ear cushions



SKU	PRODUCT
564101	OREGON Professional Safety Helmet

## MSA V-Gard® Slotted Cap with Fas-Trac III Suspension

MSA  
The Safety Company

### SPECS

**Colors** Gloss finish - White, Red, Orange, Yellow  
**Weight** 0.833 LB (0.378 KG)  
**Size** Standard (6-1/2" to 8")  
**Standards** ANSI/ISEA Z89.1-2014 (Class E); CSA Z94.1-2015 (Class E)

### FEATURES

- Polyethylene shell provides superior impact protection
- Self-adjusting crown straps ensure a comfortable fit

SKU	PRODUCT
MSA475360	MSA V-Gard Hard Hat - Yellow
MSA488146	MSA V-Gard Hard Hat - Orange
MSA475363	MSA V-Gard Hard Hat - Red
MSA475358	MSA V-Gard Hard Hat - White

**V-Gard Slotted Cap with Fas-Trac III Suspension** offers comfort, quality, and durability. Distinctive trademark "V" design. All V-Gard Helmets have UV inhibitor molded right in.





CUSTOMIZED PRODUCT

## Forestry Helmet Kit

Finally a top quality forestry/grounds person helmet kit that doesn't break the bank.

### SPECS + FEATURES

- MSAV-Gard ratcheting helmet with 5 point suspension
- 3M Peltor 105 muffs rated at 30dB
- 3M Peltor metal face screen with visor
- Color Options: Orange, Yellow, Red, White

SKU	COLOR	PRODUCT
009094	Orange	Forestry Helmet Kit
011066	Red	Forestry Helmet Kit
011615	White	Forestry Helmet Kit
012319	Yellow	Forestry Helmet Kit



## 3M Peltor Steel Mesh Helmet Visor System

**Steel Mesh Helmet Visor System** face protection for working and standby positions offers protection and visibility. Breathes well and flips up and down easily.

### SPECS + FEATURES

- Perfect combination of protection, visibility, and safety.
- Matte black steel mesh visor for good ventilation and face protection.
- Specially designed peak protects eyes from glare and reflection.
- System can be used with a variety of hard hats or with Peltor muffs.

SKU	PRODUCT
3MRV4A-10P	3M Peltor Steel Mesh Helmet Visor System



3M

USED WITH  
3M PELTOR MUFFS

## ERB Helmet Sweatband Terry Cloth



### SPECS + FEATURES

- 100% plush absorbent cotton
- Universal fit
- Fits around most hard hat suspensions
- Easily attaches to suspension with plastic snaps
- Machine washable

SKU	PRODUCT
10027	Helmet Sweatband Terry Cloth



KEEP YOUR HELMET SMELLING  
FRESH WITH WASHABLE  
REUSABLE SWEATBANDS!

## Fox 40 Whistle with Retractable Lanyard



Sticky back retractable lanyard with **Fox 40** orange whistle. Be heard without yelling.

SKU	PRODUCT
0027-06COMBO	Fox 40 Whistle & Retracting Lanyard - Orange



LOUD ENOUGH TO BE  
HEARD OVER EQUIPMENT!

# safety glasses

## Elvex Acer Ballistic Mirror



**Acer Ballistic Mirror Safety Glasses** are smart and sophisticated looking safety glasses. The new generation of **Acer** offers all the features that users are looking for in a stylish safety glass. **Acer** has a sophisticated and classy look and feel.

### SPECS + FEATURES

- Full coverage lens, with a floating design
- Soft rubber nose bridge
- Comfortable light weight fit
- Meets ANSI Z87+ high velocity requirements; CE certified and complies with EN-166 requirements

SKU	PRODUCT
SG-12M	Acer Ballistic Mirror Safety Glasses



## Elvex AirSpecs Steel Mesh Goggles



The **Elvex AirSpecs** stainless steel non-rusting mesh "lens" are designed to protect the eye socket from pokes and prods of stationary or very low energy, non-fragmenting objects over 1 mm. Great for humid environments too.

### SPECS + FEATURES

- Reduces visible light by 60% and the anodized coating on the mesh reduces reflections and glare
- EVA foam provides a great face seal and eye socket protection
- Pantoscopic angle adjustment temple allows a better fit on more faces
- Elastic fabric headband is adjustable for a comfortable, secure fit
- Meets ANSI Z87.1 for basic impact (1" ball-drop) protection

SKU	PRODUCT
GG-50	AirSpecs Steel Mesh Goggles



## Elvex Avion Ballistic



**Elvex Avion** glasses are designed to fit smaller facial configurations. Mono-lens construction, with wrap around lens. It looks good and it fits like a glove!

### SPECS + FEATURES

- Colorful rubber tipped temples and a soft rubber nose bridge
- All lenses provide 99% UV protection
- Complies with ANSI Z87.1-2015 and CE EN-166
- VO Ballistic Rated: Tested to US Military standard MIL PRF-31013, VO impact resistance requirement of 640 feet per second, 4 times the ANSI Z87 standard.

SKU	PRODUCT
SG-18C	Avion Ballistic Safety Glasses - Clear
SG-18G	Avion Ballistic Safety Glasses - Gray
SG-18A	Avion Ballistic Safety Glasses - Amber
SG-18C	Avion Ballistic Safety Glasses - Clear Slim



SG-18C



SG-18C SLIM



SG-18G



SG-18A





## Elvex Helium 15

Weighing only 15 grams – They are so light that you'll forget that you are wearing them! The lightest eyewear on the market that maintains Class 1 optics. Temples securely hold the frame in place for better non-slip compliance. Distortion-free wraparound polycarbonate lens absorbs 99.9% of harmful UVA, B and C, 180-380nm.

### SPECS + FEATURES

- Offers superior peripheral vision and protection
- Ergo Fit contour temples, follows the shape and lies flat to your head
- Fits well with hearing protectors and other PPE
- Meets ANSI Z87.1-2010+, CE EN-166 MPN: SG-58G



SG-58G



SG-58C-AF

SKU	PRODUCT
SG-58G	Helium 15 Safety Glasses – Grey
SG-58C-AF	Helium 15 Safety Glasses – AF/PC Clear

## Elvex Helium 18

Elvex Helium 18 designed for workers who don't want to wear eyewear protection. Extremely Comfortable. Secure Fit. Ultra-Light Eyewear! Weighs only 18 grams and maintains a Class 1 optics! Temples securely hold the frame in place for better non-slip compliance.

### SPECS + FEATURES

- 50% Copper Blue Blocker lens, that reduces glare and enhances visual acuity
- Ergo Fit contour "drop" temples, follows the shape and lies flat to your head
- Fits well with hearing protectors and other PPE
- Contemporary rectangular semi-frame style looks great on all face configurations
- Ample universal nose bridge for better fit and comfort
- Polycarbonate lenses absorbs 99.9% of harmful UVA, B and C, 180-380nm
- Meets ANSI Z87.1-2010+, CE EN-166



SG-59C



SG-59G



SG-59BB50-AF



SG-59G-AF



SKU	PRODUCT
SG-59C	Helium 18 Safety Glasses – Clear
SG-59G	Helium 18 Safety Glasses – Grey
SG-59BB50-AF	Helium 18 Safety Glasses – AF/PC Blue Blocker
SG-59G-AF	Helium 18 Safety Glasses – AF/PC Grey

# safety glasses

PERSONAL PROTECTIVE EQUIPMENT / SAFETY GLASSES

## Elvex OVR-Spec

**Elvex OVR-Spec** is a contemporary design with built in side windows for extra protection and comfortable rubber tipped temples. This model fits over medium sized prescription glasses measuring up to 5¾ inch (145 mm) wide.

### SPECS + FEATURES

- Clear hard coated polycarbonate lens offers 100% UV Protection
- The front lens curvature is relatively flat
- Ballistic VO Rated & High Velocity Impact Resistant
- Temples with angle & length adjustments
- Complies with ANSI Z87.1-2010 (+) & CE-EN-166



SKU	PRODUCT
SG-37C	OVR-Spec Safety Glasses – Clear
SG-37G	OVR-Spec Safety Glasses – Gray



SG-37C



SG-37G

## Elvex Impact Safety Sunglass Series

**Elvex Impact Safety Sunglass Series** is bold in style, high in performance, and ballistic-rated protection! Polycarbonate lenses absorb 99.9% of harmful UVA, B and C, 180-380nm. **RSG100 Series** – Bold sunglass style with wraparound soft temple tips. **RSG200 Series** – Classic sunglass style in Glossy Black Frame and Two Tone Copper Black. **RSG300 Series** – Removable brow pad for added protection. Lens inclination for customized fit. **RSG400 Series** – features a stylish and modern frame with Blue Blocker lens which reduces glare and blue light and increases contrast and sharpens focus.

### SPECS + FEATURES

- Flexible, rubber nose bridge to prevent slippage.
- Complies with ANSI Z87.1-2015 & CE-EN-166.
- Ballistic-rated, tested to US Military Standard MIL-PRF-31013 Impact Test.
- Flexible, rubber nose bridge to prevent slippage



SKU	PRODUCT
RSG100	Impact Safety Sunglass – Black Frame/Black Temple/Blue Lens
RSG101	Impact Safety Sunglass – White Frame/Orange Temple/Orange Lens
RSG200	Impact Safety Sunglass – Black Frame/Red Mirror Lens
RSG201	Impact Safety Sunglass – Black Frame/Grey Temple/Orange Lens
RSG300	Impact Safety Sunglass – Black Frame/Grey Temple/Silver Mirror Lens
RSG301	Impact Safety Sunglass – Black Frame/Black Temple/Blue Lens
RSG400	Impact Safety Sunglass – Black Frame/Black Temple Blue Blocker



RSG100



RSG101



RSG200



RSG201



RSG300



RSG301



RSG400



## Elvex TTS



The **Elvex TTS** offers a close fit and excellent protection for an economical pair of safety glasses.

### SPECS + FEATURES

- Hard coated polycarbonate lens
- Universal nose bridge and temple tips
- 100% UV protection
- Complies with ANSI Z87.1-2010 (+) & CE EN-166

SKU	PRODUCT
SG-15G	TTS - Grey
SG-15C	TTS - Clear



SG-15G



SG-15C

## Elvex XTS



The **XTS** offers great wraparound coverage and sporty design without sacrificing comfort and protection. Plus, it's Ballistic VO rated!

### SPECS + FEATURES

- Hard coated polycarbonate lens offering 100% UV protection
- Anti-slip rubber temple tips for added comfort
- Soft, rubber nose bridge
- Complies with ANSI Z87.1-2010 (+) and CE EN-166

SKU	PRODUCT
SG-24M	XTS - Mirror Red Frame
SG-24G	XTS - Grey



SG-24M



SG-24G

## Elvex Sphere-X Ultimate Ballistic



Introducing the new generation **Sphere-X Ultimate Ballistic** with unique lens/frame ventilation slots allows air to vent, to minimize fogging. Excellent industrial grade protection in a contemporary angular wrap style and with wide field of vision.

### SPECS + FEATURES

- Adjustable length drop temples that gently "hook" behind the ears to prevent slipping during work activity for better protection
- Soft, self-fitting rubber nose bridge conforms to a wide range of bridge sizes to enhance comfort and a secure fit
- Ballistic VO rating - 7x ANSI Z87+ energy (4x Z87+ impact velocity)
- Tested to US Military Standard MIL-PRF-31013 Impact Test
- Meets ANSI Z87.1-2010 (+)MPN: SG-51M, SG-51BB

SKU	PRODUCT
SG-51M	Sphere-X Ultimate Ballistic - Silver
SG-51BB	Sphere-X Ultimate Ballistic - Copper



SG-51M



SG-51BB

## Elvex Sonoma



The new **Sonoma** safety glass model is probably the best looking model in the Elvex product line. It seems to fit a great variety of facial configurations very well.

### SPECS + FEATURES

- Sophisticated design and great style!
- Skin tone frame colors, including tortoise finish
- Vented soft rubber nose bridge
- Rubber tipped temples for extra comfort
- Compliance: ANSI Z87.1-2010

SKU	PRODUCT
SG-350M	Sonoma



# safety glasses

PERSONAL PROTECTIVE EQUIPMENT / SAFETY GLASSES

## Elvex Xenon



**Elvex Xenon** – Ultra lightweight makes these ultra popular worldwide, weighing only 0.77 oz. (22 g)!

### SPECS + FEATURES

- Stylish looks with a comfortable fit
- Soft rubber nose bridge and colorful rubber temple inserts.
- Polycarbonate lenses absorbs 99.9% of harmful UVA, B and C, 180-380nm
- Compliance: ANSI Z87.1-2010 certified.

SKU	PRODUCT
SG-14C	Xenon Wrap – Clear
SG-14I/O	Xenon Wrap – Indoor/Outdoor
SG-14A	Xenon Wrap – Amber
SG-14B	Xenon Wrap – Ice Blue
SG-14M	Xenon Wrap – Blue



SG-14C



SG-14A



SG-14M



SG-14I/O



SG-14B

## ERB Boas®



**Boas** have a snug fit and lightweight wraparound design providing excellent protection, at a moderate price. The single lens, with an integrated nose piece, makes the selection of the **ERB Boas** an ultra-cool choice for an arborist.

### SPECS + FEATURES

- Lightweight wraparound design with integrated nose piece
- Lenses provide 99.9% UVA/B protection
- Meets ANSI Z87+ standards

SKU	PRODUCT
15280-SMOKE	Boas Smoke
15308-INDOOR/OUT	Boas In/Out
15400-CLR ANTI FOG	Boas Clear
15287-BLUE	Boas Blue



15280-SMOKE



15308-INDOOR/OUT



15400-CLR ANTI FOG



15287-BLUE

## ERB Inhibitor®



Frameless wraparound design fit provides optical protection. 4-position adjustable temple with non-slip rubber tips.

### SPECS + FEATURES

- Lenses offers 99% UV protection
- Stainless steel hinge screws
- Meets the requirements of ANSI Z87.1

SKU	PRODUCT
17970 BROWN SMOKE	Inhibitor Smoke
17969 CLEAR	Inhibitor Clear



17970 BROWN SMOKE



17969 CLEAR





## ERB Invasion®

ERB Invasion offers great wrap around protection. Hard coated polycarbonate lens offers 99% UV protection. Rubber temple tips and nose pad for hold and flexibility.

### SPECS + FEATURES

- Soft nose pads for comfortable fit
- Flexible rubber temples with a frameless wraparound design
- 9 base curve single lens
- Meets the requirements of ANSI Z87.1 – High Impact

SKU	PRODUCT
15536	Economy Invasion – Smoke



## ERB Strikers®

Sporty wraparound design is aerodynamic and frameless. 6.5 base curve polycarbonate lens is shaped to fit facial contours.

### SPECS + FEATURES

- 99% UV protection
- Anti-Fog
- Adjustable nose pad for comfortable fit
- Meets ANSI Z87.1 – High Impact.

SKU	PRODUCT
15426	Strikers – Clear Anti Fog



## ERB SuperBS®

ERB SuperBS safety glasses have a stylish wraparound design and high-gloss finish. 9.5 base curve makes the shape fit snugly for total optical protection.

### SPECS + FEATURES

- Integrated nose pads
- Stainless steel hinge screws
- One piece spherical polycarbonate lens offers 99% UV protection
- Meets requirements of ANSI Z87.1 – High Impact

SKU	PRODUCT
16506	SuperBS – Gray-Blue



## ERB 24" Spectacle Strap

Keep your safety glasses securely in place with one of these affordable, high visibility straps made of a polypropylene blend.

### SPECS + FEATURES

- Plastic loop eyewear retainer
- Metal detectable
- Rubber loops attach to eyewear temples

SKU	PRODUCT
15707	24" Spectacle Strap – Hi-Viz Orange

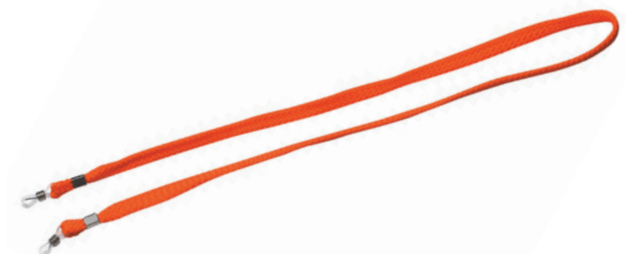

# safety glasses

PERSONAL PROTECTIVE EQUIPMENT / SAFETY GLASSES

**OREGON**

## Oregon Luminary®

Ultra-lightweight design (0.08 lbs) makes it easy to wear all day, every day. Design includes unique, translucent temple insets for an electrifying new look.

### SPECS + FEATURES

- Elastic temples help relieve pressure behind the ears and provide superior comfort.
- Fingertip nose piece reduces slippage, so glasses stay on securely.
- Large, one-piece polycarbonate lens, with an anti-scratch coating, offers durable protection.
- Wrap-around design, along with an integrated browguard, ensures complete protection.

SKU	PRODUCT
42-141	Luminary - Clear/Black
42-142	Luminary - Gray/Silver
42-143	Luminary - Amber/Black
42-144	Luminary - Pacific Blue Lens/Black
42-145	Luminary - Orange/Black
42-146	Luminary - Silver Mirror/Silver
42-147	Luminary - Blue Mirror/Black



42-141



42-142



42-143



42-145



42-144



42-146



42-147

ULTRA-LIGHTWEIGHT  
AND EASY TO WEAR ALL  
DAY, EVERY DAY

## Elvex RX-350 Bifocal Safety Glasses

**ELVEX**  
DELTA PLUS PARTNER

The **Elvex RX-350** bifocal safety glasses has our anti-fog coating, making this product versatile in multiple environments and offers superior eye protection with all day comfort.

Don't reach for a second pair of glasses to read your work order, to file your saw, or read your phone. One pair of glasses during your work day, and protects your eyes to Z87.1!

### SPECS + FEATURES

- Soft rubber nose bridge and temple inserts
- Clear - Complies with ANSI Z87.1-2010 (+)
- Sonoma - Blocks 99.9% of harmful UV radiation; Complies with ANSI Z87.1-2015 (Z87+)

SKU	STRENGTH	PRODUCT
RX-350C-1.0	1.0	RX-350 Bifocal Safety Glasses
RX-350BR-1.0	1.0	RX-350 Sonoma Bifocal Safety Glasses
RX-350BR-2.0	2.0	RX-350 Sonoma Bifocal Safety Glasses





# safety gloves

## Elvex ProGloves™ Chainsaw Gloves

Safe handling of chain saws begins with Elvex ProGloves™ with protective padding that stops the cutting action in seconds. Prolar™ protection on back of left hand, effectively jams chain to quickly stop cutting action.

### SPECS + FEATURES

- Certified to world's leading standard: CE EN 388:4244 and CE EN 381-7; Design A/B, Class 1-20(m/s)
- Extended leather cuffs with Velcro closure, customizes fit and keeps out saw dust, chips and debris
- Rugged, wet-weather construction, water-resistant nylon fabric on upper side and suede skin on the inside for better wet weather gripping power.

SKU	PRODUCT
JEGLV-50-XL	ProGloves - Large
JEGLV-50-MED	ProGloves - Medium



**ELVEX**  
DELTA PLUS PARTNER

## OREGON Chain Saw Gloves

High visibility leather gloves offer chain saw protection.

### SPECS + FEATURES

- Left-hand chainsaw protection with knitted cuffs
- Exposed areas are seamless and reinforced with leather
- Waterproof, reinforced kid leather palm and hard-wearing, fluorescent water-repellent polyester back

SKU	PRODUCT
91305M	Gloves Oregon Chain Saw Gloves - Medium
91305L	Gloves Oregon Chain Saw Gloves - Large
91305XL	Gloves Oregon Chain Saw Gloves - Extra Large



**OREGON**

## Arbortec AT975 Pro Class 1 Chainsaw Gloves

The **Arbortec AT975 Pro Class 1 Chainsaw Gloves** are the best arborist glove available with dual hand chainsaw protection and reinforced leather palm combined with maximum comfort.

### SPECS + FEATURES

- Maximum comfort
- Protection is in both gloves
- Quality hide chainsaw glove
- Reinforced leather palms for longer life
- Ultra snug fit Velcro wrist closure
- Rain resistant backing

SKU	PRODUCT
AB301112	AT975 Chainsaw Glove - Medium
AB301113	AT975 Chainsaw Glove - Large



**ARBORTEC**

# safety gloves

PERSONAL PROTECTIVE EQUIPMENT / SAFETY GLOVES

## Arbortec AT1550 XT Chainsaw Glove

The **Arbortec AT1550 XT Chainsaw Glove** is a close fitting, dexterous leather glove with rubberized finger grips and low profile palm padding. This glove will rise to meet your expectations on all fronts – comfort, durability, wearability.

### SPECS + FEATURES

- XT Grips at fingertips: good grip in wet
- Internally sewn palm pads: reduced exposure to wear & tear
- Breathable 4 way stretch back: comfort and reduced humidity
- Unique cut away wrist design
- Reinforced pull-on tab: for easy on/off

SKU	PRODUCT
AT1550 L(10)	AT1550 Chainsaw Glove - Large
AT1550 XL(11)	AT1550 Chainsaw Glove - Extra Large



ARBORTEC

## Arbortec AT2000 XScape Climbing Glove with Extended Cuff

Made from a high density polymer, the fibers from which this glove is constructed are incredibly strong and cut resistant. With a grippy PU coating, the **AT2000** has become a very popular glove for climbers who don't require full chainsaw protection.

### SPECS + FEATURES

- Light and dexterous knitted construction; high durability
- Tough PU coating
- Highly breathable
- Level 5 Cut Resistant
- EN388 4,5,4,3

SKU	PRODUCT
AB950051	AT2000 XScape Climbing Glove - Medium
AB950052	AT2000 XScape Climbing Glove - Large
AB950053	AT2000 XScape Climbing Glove - X Large
AB950054	AT2000 XScape Climbing Glove - XX Large



ARBORTEC

## Arbortec AT-20° Thermally Insulated Cold Weather Glove

Say goodbye to numb fingers and frostbite. The **AT-20°** glove is designed to help keep work levels up even when the temperature is sub-zero. The palm of the glove is full leather, with a rubberized reinforced palm patch for grip and durability.

### SPECS + FEATURES

- Fully lined with thermal insulator: keeps you warm at sub-zero temperatures
- Cozy knitted long cuff: extra protection under jacket cuffs
- Leather palm and fingers: for breathability and hard wear
- Reflective strips across finger tips: extra safety feature
- Rubber palm reinforcement: good grip when wet, and extra durability

SKU	PRODUCT
AB300223	AT20 Winter Work Glove - Small
AB300224	AT20 Winter Work Glove - Medium
AB300225	AT20 Winter Work Glove - Large
AB300226	AT20 Winter Work Glove - Extra Large



ARBORTEC



## Arbortec AT1500 XT Work Glove

The **Arbortec AT1500 XT Work Glove** is a favorite all day, every day work glove. Made from stretchable goat leather with a very close fit for improved dexterity, and a cut-away cuff design. The palm features internal padding, and the fingers are tipped with a tactile material to increase grip.

### SPECS + FEATURES

- Breathable 4-way stretch back
- Water resistant and lightweight
- Reinforced pull-on tab for easy on and off
- Leather finger nail protectors for added protection

SKU	PRODUCT
AB300263	AT1500 XT Work Glove - Large
AB300264	AT1500 XT Work Glove - Extra Large



## SHOWA® Rubber Grippy Gloves

Great for jobs where your hands are near water. This is your glove if you want dry hands. Great for tree planting jobs, fertilizer jobs, and much more.

### SPECS + FEATURES

- 306 13-Gauge Black Dual Foam Latex
- Fully Dipped Coated Worked Glove with Knit Wrist
- Seamless Blue Knit Nylon
- Polyester Liner

SKU	PRODUCT
B13306M-07	SHOWA Rubber Coated - M
B13306L-08	SHOWA Rubber Coated - L
B13306XL-09	SHOWA Rubber Coated - XL



## Atlas ThermaFit Gloves

**Atlas ThermaFit Gloves** are popular for cold weather climbing. They have a cotton/polyester double napped acrylic liner that provides a cushion of air to protect hands from cold applications, as well as natural rubber coating on the palm and fingertips to offer excellent abrasion resistance. Bulk option available.

### SPECS + FEATURES

- Puncture & Abrasion Resistant
- Excellent Grip
- Poly-Cotton/Acrylic liner
- Tough natural rubber coating on a breathable fleeced knit liner

SKU	PRODUCT
B13451S12PK	ThermaFit - Dozen S
B13451M12PK	ThermaFit - Dozen M
B13451L12PK	ThermaFit - Dozen L
B13451XL12PK	ThermaFit - Dozen XL
B13451S-07	ThermaFit - S
B13451M-08	ThermaFit - M
B13451L-09	ThermaFit - L
B13451XL-10	ThermaFit - XL





# safety gloves

PERSONAL PROTECTIVE EQUIPMENT / SAFETY GLOVES

## Atlas Fit Blue Gloves

These blue go-to gloves are a great general purpose work glove. With their ergonomic design, superior fit, and durability, these gloves are the popular choice of professionals. Bulk option available.

### SPECS + FEATURES

- Puncture Resistant
- Abrasion Resistant
- Excellent Grip
- Save a little, buy in bulk

SKU	PRODUCT
B13300S12PK	Fit - Dozen S
B13300M12PK	Fit - Dozen M
B13300L12PK	Fit - Dozen L
B13300XL12PK	Fit - Dozen XL
B13300S-07	Fit - S
B13300M-08	Fit - M
B13300L-09	Fit - L
B13300XL-10	Fit - XL



Kate Odell, Certified Arborist, Northern Arboriculture, NH  
(Kask Zenith Helmet and Double Rope Climbing)



# hearing

PERSONAL PROTECTIVE EQUIPMENT / HEARING COMMUNICATION

**SENA**

## Sena 10R Low Profile Bluetooth® 4.1 Dual

When you are tired of yelling over equipment to have a conversation with your team, Bluetooth Communication is for you. Talk to one another in a conversational tone, no need to raise the volume of your voice anymore.

The **Sena 10R** is mounted directly to your helmet with high strength Velcro, that won't come off until you want it to. Low profile is the **10R's** strong suit and is easy to operate, even with gloves. No buttons to get unintentionally bumped while working in the canopy or on the ground. Pairs will all other **Sena** units. Charges with USB mini cable and free software upgrades available directly from **Sena**.

### SPECS + FEATURES

- Talk time: 10 hours
- Operating temperature: -10°C - 55°C (14°F - 131°F)
- Bluetooth 4.1
- Weight: Main Module - 22 g (0.78 oz)
- Working distance: up to 900 m (980 yds) in open terrain
- Supports up to 4 helmets
- CERTIFICATES: CE, FCC, IC

SKU	PRODUCT
10R-01D	10R Low Profile 4.1 - Dual
10R-01	10R Low Profile 4.1 - Single

SOME INSTALLATION REQUIRED.



## Sena SPH10 Bluetooth Stereo Headset and Intercom

Extremely versatile with a long range, the **SPH10 Bluetooth Stereo Headset** brings your favorite tunes, GPS navigation instructions, full-duplex intercom conversations featuring a 900-meter range, and hands-free calling. For both incoming and outgoing audio. Great for all outdoor activities.

### SPECS + FEATURES

- Bluetooth 3.0
- Intercom up to 900 meters
- Four-way Intercom
- Advance noise control
- Voice prompts
- Connects with all *Jog wheel*, the newer SMH10R, and TuffTalk styles

SKU	PRODUCT
SPH10-10	SPH10 Bluetooth Stereo Headset and Intercom

**SENA**

GREAT FOR OPERATORS IN EQUIPMENT OR CABS



## Sena TuffTalk Lite - Headband or Helmet Muffs

**Sena's** industrial strength earmuff featuring a minimal, yet protective design.

### SPECS + FEATURES

- Two styles: Clip into any helmet or wear over the head
- Pairs with other Bluetooth communication devices (3.0, 4.1 etc.)
- 4-way intercom
- Smartphone App
- Water resistant
- Talk Time: 13 hours
- Working distance: up to 800 m in open terrain
- NRR (ANSI S3.19-1974, US): NRR: 20db (muffs); 21db (headband)
- SNR (EN352-3, EU): 27 dB, H= 32 dB, M= 24 dB, L= 17 dB
- CE, FCC, IC

SKU	PRODUCT
TUFFTALK-LITE-01	TuffTalk Lite Headband
TUFFTALK-LITE-02	TuffTalk Lite Helmet Mount

**SENA**



## Sena TuffTalk M



Mesh networking creates near-limitless connections. Mesh is a self-optimizing and self-healing network, always looking for the best connection and seeking a new one when a device disconnects.

### SPECS + FEATURES

- Effective range of 0.7 miles (1.1 km)
- Two operation modes: Open Mesh (unlimited within 0.7 miles) and Group Mesh (up to 24 participants)
- Pair up to four TuffTalk via Bluetooth Intercom.
- Multiple channels to choose from
- Use a Sena App for visual control at your fingertips
- Styles: Over-the-head earmuffs (26dB) and Hard hat integrated (24dB).
- Hands-free intercom system with three-button layout making it easy to control

SKU	PRODUCT
TUFFTALK-M-01	TuffTalk Mesh Headband
TUFFTALK-M-02	TuffTalk Mesh Helmet Mount







## 3M™ Peltor™ Helmet Mounted Ear Muff Dielectric X4P5E

Electrically insulated **X4P5E**, the newest member of the **3M Peltor** Helmet Mounted Hearing PPE. This lightweight, low-profile earmuff is compatible with other personal protective equipment and is designed for protection against mid to high level industrial noise and other loud sounds.

### SPECS + FEATURES

- Universal mounting attachment fits most hard hats
- Electrically insulated (Dielectric) Fit can be verified with 3M™ E-ARfit™ Dual-Ear Validation System
- Soft, wide dual-molded cups for comfort without excess weight
- Noise Reduction Rating (NRR): 25 dB, CSA Class A
- Replaceable ear cushions and foam liners (hygiene kit HX3)

SKU	PRODUCT
3MRX4P5E	Ear Muff Dielectric X4P5E



NRR: 25 dB

## 3M Peltor X Series Ear Muffs X4P3

A high performance hearing protector for use against high noise levels in a wide range of industries, offering 32(dB) attenuation with a sleek, low profile aesthetically pleasing design.

### SPECS + FEATURES

- Streamlined cups without compromising attenuation
- Lightweight dual moulded cups with maximum space inside to help minimize heat and moisture build-up
- Integrated design for more robustness
- Noise reduction rating (NRR): 25dB; SNR: 33dB
- Weight: 236 g

SKU	PRODUCT
3MRX4A	Ear Muff Headband Peltor X4



NRR: 25 dB



## 3M Peltor Optime™ 105

**3M Peltor Optime 105** cap attached earmuffs feature double-shell technology to provide effective hearing protection.

### SPECS + FEATURES

- Proprietary Twin-Cup™ design has soft, foam-filled earmuffs
- Easy cap-mount design
- Earcup pivot points that tilt for optimum comfort and efficiency
- Liquid/foam filled earmuff cushions
- Color-coding to help match attenuation needs
- For noise levels up to 105 dBA; NRR\*: 27 dB. CSA Class AL

\*The NRR may overestimate the hearing protection provided during typical use. 3M recommends reducing the NRR by 50% for estimating the amount of noise reduction provided.

SKU	PRODUCT
3MRH10P3E(10 CS) BLK	Ear Muff Helmet 3M Peltor 105

Most Hearing Protection Available



NRR: 27dB



## 3M Peltor H31P3E Deluxe



**3M Peltor H31P3E Deluxe** is a top quality and comfortable hearing protector with excellent attenuation. Interchangeable and hygienically safe ear covers. The sealing rings have ventilation canals and are coated with soft, patterned hygienic foil.

### SPECS + FEATURES

- The protector can be set in the working, airing, or park position.
- Wide ear cushions for comfort and patented liquid & foam-filled cushions for better seal and lower pressure.
- Simple height adjustment
- Four-point suspension to help distribute cushion pressure evenly
- Twin cup design minimizes resonance, thus achieving maximum high and low frequency attenuation. For noise levels up to 98 dBA; NRR: 23 dB
- Standard ANSI 53.19-1974

SKU	PRODUCT
3MRH31P3E (10 CS) OR	Ear Muff Helmet 3M Peltor H31



## 3M Peltor X3P3E Ear Defenders



Designed to offer protection against high noise levels. The **3M Peltor X3's** are a narrow profile ear muffs that will mount on most hard hats and helmets.

### SPECS + FEATURES

- They offer a slightly larger cup than the X4P3E model.
- The next generation of helmet mounted hearing protection.
- Solid noise reduction given the unit's size, NRR: 25 dB

SKU	PRODUCT
3MRX3P3E RED GRAY	Ear Muff Helmet 3M Peltor X3

NRR: 25 dB



## Howard Leight Banded Ear Plugs



Ideally designed for people who are exposed to intermittent noise for giving solid protection. Supra-aural fit are lightweight portable earplugs that feature soft pods that rest partially in the ear for balanced comfort and protection. The Inner-aural fit are smooth ergonomic pods that fit inside the ear canal for maximum protection in patented band design secure ear pods from touching dirty or contaminated surfaces.

### SPECS + FEATURES

- Smooth, ergonomic pods fit in the ear for maximum protection
- Patented band design prevents ear pods from touching dirty or contaminated surfaces
- Lightweight and portable: designed especially for environments with intermittent noise hazards
- Includes pair of replacement pods
- Supra-aural fit: 25 dB NRR; Inner-aural fit: 27 NRR

SKU	PRODUCT
HONQB2HYG	Supra-aural fit Banded Ear Plugs
HLIQB200HYG	Supra-aural fit Replacement Buds
HONQB1HYG	Inner-aural fit Banded Ear Plugs
HLIQB100HYG	Inner-aural fit Replacement Buds

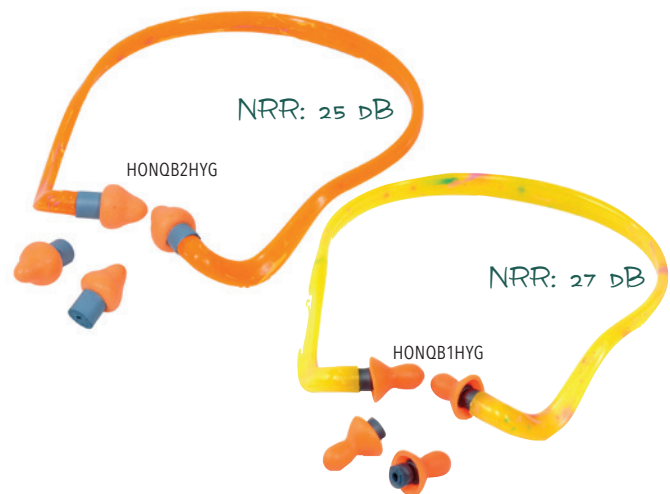



## Elvex GelPods™ / GelCaps™ Headband



Elvex GelPods/GelCaps are easier to insert than an ear plug, and since it is kept in place by the headband force, it does not have to be as deeply inserted. The pods are made from a unique composite three times as soft as the softest reusable silicone ear plug. Extraordinary sound reduction properties in the low and high frequencies.

### SPECS + FEATURES

- Universal size; Designed to be worn around neck when not in use
- GelPods: 23 NRR (ANSI) and 23 SNR (CE) Protection Level: 92–102 dB
- GelCaps: 18 NRR (ANSI) and 22 SNR (CE) Protection Level: 89–99 dB

SKU	PRODUCT
GP-10	Ear Plug Band GelPods
GC-20	Ear Plug Band GelCaps

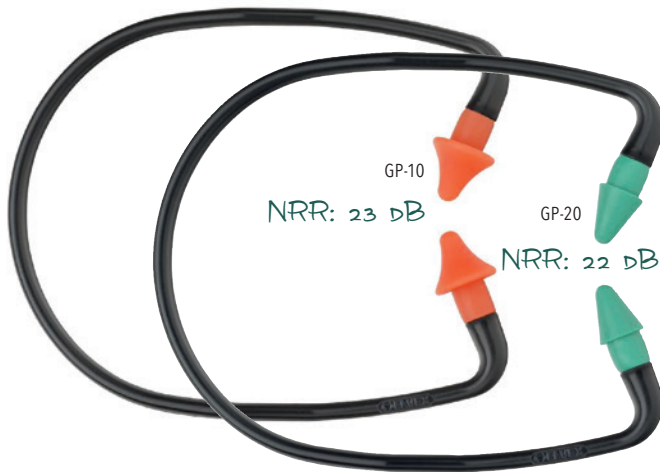

## Elvex BLUE™ Disposable Foam Ear Plugs



Elvex BLUE ear plugs have been tested to ANSI S3.19-1974 at an independent and certified laboratory. BLUE EP-253 corded ear plug provides the user with a high level of hygiene and excellent hearing protection. Corded ear plugs prevent loss and keep hearing protection readily available.

### SPECS + FEATURES

- Universal size, easy to insert, correctly fits with moderate expansion
- Soft low pressure polyurethane foam with smooth surface, provides all-day comfort to improve worker compliance.
- High visibility bright blue, easy to monitor and enforce proper ear plug usage.
- 32 dB NRR
- Corded: 100 pairs per box; Plugs: 200 pairs per box

SKU	PRODUCT
EP-253	Ear Plug BLUE Disposable Foam Ear Plugs
EP-251	Ear Plug BLUE Disposable Foam Ear Plugs with cord



## Elvex Uni-Fit Standard Foam Ear Plugs



Uni-Fit foam ear plugs have a noise reduction rating of 32 dB and have been tested to ANSI S3.19-1974 at an independent and certified laboratory. They are CE certified and tested to EN-352 by INSPEC Laboratories in the UK. Uni-Fit EP-153 corded disposable ear plugs are better in performance than leading brands. High visibility color makes it easy to see and monitor worker compliance.

### SPECS + FEATURES

- Universal size, easy to insert, correctly fits with slow expansion
- Tapered shape with longer, thinner tip provides extremely high comfort level.
- 32 dB NRR
- Corded: 100 pairs per box; Plugs: 200 pairs per box

SKU	PRODUCT
EP-151	Ear Plug Uni-Fit Disposable Foam Ear Plugs
EP-153	Ear Plug Uni-Fit Disposable Foam Ear Plugs with cord



## 3M Single Use E-A-Rsoft FX Earplugs



3M E-A-Rsoft FX earplugs feature a patented bell-shape to more effectively fit the ear canal. Tests in an accredited NVLAP laboratory showed they provide the highest Noise Reduction Rating of any earplug in the industry - NRR 33 dB. You can't get any higher protection.

### SPECS + FEATURES

- Highest Noise Reduction Rating of any earplug in the industry - NRR 33 dB
- Made of a custom polyurethane foam formulation for slow recovery and increased softness in the ear canal.
- Made in USA.
- Standards: Meets ANSI S3.19-1974
- Qty: 1 Pair Per Poly Bag

SKU	PRODUCT
CAS312-1261	Ear Plug E-A-R Classic Soft



MOST PROTECTION!  
NRR: 33 dB

## 3M Peltor Ear Muff Hygiene Kit

Ear muff seals deteriorate over time and lose their effective decibel reduction, not to mention get a bit stinky!

### SPECS + FEATURES

- Ear muff seals deteriorate over time and lose their effective decibel reduction.
- Replace yours to restore that fresh brand new earmuffs level of noise protection.
- Extend the life of your 3M Peltor earmuffs with a pair replacement cushions and dampers.

SKU	PRODUCT
3MRHY3	Hygiene Kit Peltor Ear Muff H3193E

3M SOLID ORANGE MUFFS



## 3M Peltor Headset/Earmuff Hygienic Pad Kit

Ideally engineered for use with X4 ear defenders only. Hygienic pad kit is convenient to fit and maintains your protective equipment in clean working order. It offers better protection with comfort design and meets the needs of a wide variety of applications, offering unparalleled attenuation in a streamlined design.

### SPECS + FEATURES

- Keeps protective equipment in clean working order
- Built in conjunction with customers and with the wearer in mind
- Combine lightweight comfort and modern styling with ground-breaking attenuation techniques
- Range of hearing protectors that meets the needs of a wide variety of applications
- Includes: 2-Foam easy to fit inserts, 2-Sealing rings

SKU	PRODUCT
3MRHYX4	Hygiene Kit Peltor Ear Muff X4P3E

X4 LOW PROFILE MUFFS



## 3M Peltor Black Earmuff Hygiene Kit

**3M Peltor Black Earmuff Hygiene Kit** includes one pair of replacement cushions and one pair of dampers that helps extend the life of your earmuffs or headsets. Kit contents are made of ABS material. It is suggested to replace at least twice yearly to ensure a consistent level of protection and comfort. Earmuff hygiene kit is designed especially for H10 series.

### SPECS + FEATURES

- Extend the life of earmuffs with 1 pair of replacement cushions and 1 pair of dampers
- Hygiene kit for H10 Series
- Fits: 105 Muff

SKU	PRODUCT
3MRHY10	Hygiene Kit Peltor Ear Muff 105



BLACK & RED 105 MUFFS





# safety clothing

## Arborwear RAC Chainsaw Chaps



The **RAC Chaps** were developed to tackle the issues with traditional chainsaw chaps. With the Patented Daisy Fit™ System, the **RAC chaps** feature a strap system where straps are: **Replaceable** if broken or lost, **Adjustable** to various leg sizes and shapes, and **Comfortable** for all day wear, reducing discomfort and fatigue. All designed in an effort to keep you working longer and safer in the field.

### SPECS + FEATURES

- 6-Layer Blocking Material - 1680 Denier Nylon Outer Layer, 400 Denier Nylon Inner Layer
- 360° of lower leg protection made with PU coating and DWR for water resistance
- Left facing wrap around pads designed for added protection from a chainsaw's natural direction of pull
- Sizing: Regular fits Inseam 30-32"; Long fits inseam 33-34"

SKU	PRODUCT
820101L	Arborwear RAC Chap Wrap - Green Long
820101R	Arborwear RAC Chap Wrap - Green Regular
820101R	Arborwear RAC Chap Wrap - Orange Regular
820101L	Arborwear RAC Chap Wrap - Orange Long



As far as chaps go, I really like the Arborwear RAC Chaps. The elasticity of the straps minimize resistance with movement and I can comfortable and ergonomically bend at the knees with a straight spine for lifting... they are also available in sufficient length for people of stature."  
 —John Massing, Certified Arborist, IN

## Arborwear Ironwood Chainsaw Pants



The industry has asked **Arborwear** for years to make chainsaw pants. They surveyed more than 1,000 members of the tree care community, developed prototypes, field tested, and found ways to improve, like zippered pockets.

### SPECS + FEATURES

- 9 oz. 4-way stretch tech nylon fabric is breathable and flexible for max comfort
- CoolCore liner that wicks and spreads moisture plus 2 CoolZip vents on the back of the legs for extra cooling
- LockSnaps™ on the center front closure that snap into place and stay put
- Lightweight 5-layer blocking material with wrap around calf protection and reinforced knees and cuffs for abrasion resistance
- Teflon™ Fabric Protector repels most water- and oil-based liquids
- Elongated pockets with fold-over Velcro® closures at the top to keep out sawdust
- UL Certified in the U.S. and Canada
- Category A: leg protection device for chainsaw users in accordance with the standard for leg protective device for chainsaw users.
- CAN/BNQ 1923-450-M91 / 3XF3

SKU	PRODUCT
820200 32W 32L	Arborwear Ironwood Chainsaw Pants - 32W 32L
820200 34W 34L	Arborwear Ironwood Chainsaw Pants - 34W 34L
820200 38W 34L	Arborwear Ironwood Chainsaw Pants - 38W 34L
820200 34W 30L	Arborwear Ironwood Chainsaw Pants - 34W 30L
820200 34W 32L	Arborwear Ironwood Chainsaw Pants - 34W 32L
820200 30W 30L	Arborwear Ironwood Chainsaw Pants - 30W 30L
820200 32W 34L	Arborwear Ironwood Chainsaw Pants - 32W 34L
820200 36W 30L	Arborwear Ironwood Chainsaw Pants - 36W 30L



TRUE TO FIT, VERY COMFORTABLE  
 WE WILL BE CARRYING WOMEN'S SIZES SOON!

# safety clothing

PERSONAL PROTECTIVE EQUIPMENT / SAFETY CLOTHING

## Oregon Apron Safety Chaps



Comfortable protection for your legs while logging or using your chainsaw in apron chaps design, with 8 layers breathable warp knit chainsaw protection.

### SPECS + FEATURES

- Conforms to ASTM F1897-08 and UL classified
- 8 layers breathable warp knit chainsaw protection
- 32in.L; waist size adjustable up to 46in.
- Rugged 600 Denier Oxford shell stands up to the rigors of the job
- Adjustable length with top snaps on waist
- 2 adjustable leg straps deliver a custom fit

SKU	PRODUCT
564132-32	Apron Safety Chaps - 32" Length
564132-36	Apron Safety Chaps - 36" Length
564132-40	Apron Safety Chaps - 40" Length



## Oregon Full-Wrap Chainsaw Chaps



Professional full-wrap design with added calf protection provides exceptional safety. Super-tough 8-layer warp knit material is breathable to keep you cool in the field.

### SPECS + FEATURES

- Conforms to ASTM F1897-08 and UL classified
- 8 layers breathable warp knit chainsaw protection; added calf protection
- 32in.L; waist size adjustable up to 46in.
- Rugged 600 Denier Oxford shell stands up to the rigors of the job
- Adjustable length with top snaps on the waist to provide added comfort
- 3 adjustable leg straps deliver a custom fit

SKU	PRODUCT
564134-32	Full-Wrap Chaps - 32" Length
564134-36	Full-Wrap Chaps - 36" Length
564134-40	Full-Wrap Chaps - 40" Length



## Zenitec Clogger Zero Chainsaw Mens Trousers

Mens (Gen 2) - Made with Lightweight Arrestex HP chainsaw protective fabric. A-style chainsaw protection; frontal protection only where it is mostly needed. Large cooling vents; Bigger rear cooling vents allows body heat to escape faster.

### SPECS + FEATURES

- Cooling outer fabric engineered to move moisture away from the skin.
- 4-way stretch allows you greater freedom of movement and flexibility.
- Outer material is UV protective shielding you from the harmful effects of the sun.
- High abrasion resistant fabric from the knee down increasing the durability.
- Fit is less roomy than the Gen 1; Extra leg length; Hi-vis panels; the bright orange panels ensures you can be seen wherever you are.
- Pockets strategically placed on thigh giving easy access when in a harness. Zipper pulls on pockets make it easier to open even when wearing gloves.
- Certified by Bureau Veritas NZ Ltd to AS/NZS 4453.3:1997 Protective Clothing for Users of Hand-held Chainsaws.

SKU	PRODUCT
TU71ZXS MENS	Zero Chainsaw Trousers - XS Mens
TU71ZS MENS	Zero Chainsaw Trousers - S Mens
TU71ZM MENS	Zero Chainsaw Trousers - M Mens
TU71ZL MENS	Zero Chainsaw Trousers - L Mens
TU71ZXL MENS	Zero Chainsaw Trousers - XL Mens
TU71ZXXL MENS	Zero Chainsaw Trousers - XXL Mens

SUPER LIGHTWEIGHT & COOL!



SUPER COMFY!  
ORDER ONE  
SIZE DOWN



## Zenitec Clogger ArborMax Ascend Cool Chap Pant

Made with Lightweight Arrestex HP chainsaw protective fabric. Slim fit offers superior comfort and reduced bulk. High-back and elasticized waist; makes waist fit snugly to your body and flexes with movement (printed with ArborMax).

### SPECS + FEATURES

- High abrasion resistant fabric from the knee down increasing the durability. Extra wear resistance with the double wall seat area.
- Adjustable cooling- zipped rear vents for breathability on warmer days
- Pockets strategically placed on the thigh for easy access when in a harness
- Extra leg length means more freedom of movement
- Slim fit cut a little more generous on the shin/thigh vs. Zero's
- Zipped pockets and zipper pulls make it easier to open pockets
- Stay dry-waterproof, tough fabric to above the knee also increases durability

SKU	PRODUCT
TU71BXS	ArborMax Ascend Cool Chap Pant - XS
TU71BS	ArborMax Ascend Cool Chap Pant - S
TU71BM	ArborMax Ascend Cool Chap Pant - M
TU71BL	ArborMax Ascend Cool Chap Pant - L
TU71BLX	ArborMax Ascend Cool Chap Pant - XL



## Zenitec Clogger Zero Chainsaw Womens Trousers

The first professional female arborist chainsaw protective trousers through the waist. Elastic waist for a snug fit and extra comfort with 50 mm belt loops.

### SPECS + FEATURES

- Moisture-wicking outer fabric and mesh cooling vents on both legs.
- 4-way stretch allows you greater freedom of movement and flexibility.
- Outer material is UV protective shielding you from the harmful effects of the sun.
- High abrasion resistant fabric from the knee down increasing the durability.
- Pockets strategically placed on thigh giving easy access when in a harness. Zipper pulls on pockets make it easier to open even when wearing gloves.
- Certified by U/L to ASTM F1897-14. Certified by U/L to BNO 1923-450-1. Meet the Worksafe BC Standard as set out in OHSR Section 8-21 (2). Certified by Bureau Veritas NZ Ltd to AS/NZS4453.3:1997.

SKU	PRODUCT
TU71ZW2XXS	Zero Chainsaw Trousers - XXS Womens
TU71ZWXS	Zero Chainsaw Trousers - XS Womens
TU71ZWS	Zero Chainsaw Trousers - S Womens
TU71ZWM	Zero Chainsaw Trousers - M Womens
TU71ZWL	Zero Chainsaw Trousers - L Womens



**Clogger Chainsaw Zero Gen2 pants** have been my go-to saw pants. They're the lightest saw pants out there and they're great in the tree and on the ground. The Clogger brand also has great size versatility, so this brand has sizes for folks that don't usually fit typical tree care sizing."

— Maria Tranguch, Certified Arborist, Legacy Land Consulting, NC

# safety clothing

PERSONAL PROTECTIVE EQUIPMENT / SAFETY CLOTHING

## Arbortec Breatheflex Pro Chap Pant – AT4070

Strong and lightweight Dyneema ensures these trousers will keep protected. New crotch design made with Kevlar to eliminate ripping and a stretchy fabric that allows for movement and flexibility. New liner which offers unrivaled comfort and will no longer trap sawdust or leg hairs in the material on the inside legs.

### SPECS + FEATURES

- Adjustable waist band and kidney pad on back of trousers for braces
- Elasticated hooks at the base of the trouser to attach to laces of boots
- Reflective decals along the side of the leg
- Zips on all pockets with tapered seams and zippered vents on back
- Protection is rated to Class 1 (20 m/s). EN381-5 Class 1 (20m/s) Type A

SKU	PRODUCT
012608	Breatheflex Pro Chap Pants – S
012609	Breatheflex Pro Chap Pants – M
012610	Breatheflex Pro Chap Pants – L
012611	Breatheflex Pro Chap Pants – XL



ARBORTEC

LOTS OF FEATURES!  
SUPER COMFORTABLE

## Arbortec Breatheflex Chainsaw Trousers – AT4010

The trousers outer shell is made from ClimaspHERE breathable fabrics which are also highly abrasion and snag resistant (a must for tree climbers) and the six-way stretch feature makes for the most comfortable forestry chainsaw pants on the market.

### SPECS + FEATURES

- Reinforced seams at high tension areas for longer lasting trousers
- Kevlar reinforcement at lower leg preventing abrasion from thorns and brush
- Quality zippers designed to survive extensive heavy use and downward facing pocket zips
- Reinforced lining around ankle reduces wear from boot lace hooks
- Hi Vis Reflective decals for improved roadside safety in low-light conditions
- Cargo and phone pockets have double fold-over flap
- Elasticated boot lace fastener reduces sawdust ingress into boot.
- Type A trouser (saw protection to the front of the leg) and the protection is rated to AT4010 – Class 1 (20 m/s) EN 381-5 Type A
- Sizes: XS-5XL (25"-54") Leg: Short 29", Regular 31"

SKU	PRODUCT
AB345131	Chap Pant Breatheflex Black – 31 REG
AB345132	Chap Pant Breatheflex Black – 32 REG
AB345133	Chap Pant Breatheflex Black – 33 REG
AB345133 SHORT	Chap Pant Breatheflex Black – 33 SHORT
AB345134	Chap Pant Breatheflex Black – 34 REG
AB345135	Chap Pant Breatheflex Black – 35 REG



ARBORTEC

NICE REFLECTIVITY AND FIT GREAT



# outerwear, first aid, + education

## Arborwear Beanie



This **Arborwear Beanie** gives you that forest *gangsta* look so popular with the kids today.

### SPECS + FEATURES

- Warm
- Material: 100% Acrylic

SKU	COLOR	PRODUCT
808283Orange	Orange	Hat Beanie
808283HI-V Yel	Yellow	Hat Beanie
808283Blue	Blue	Hat Beanie
808283Green	Green	Hat Beanie
808283Black	Black	Hat Beanie
808283	Olive	Hat Beanie



HI-VIS YELLOW



BLUE



GREEN



BLACK



OLIVE



HI-VIS ORANGE

## Arborwear Double-thick Hooded Pullover Sweatshirt



A treat to yourself a hooded pullover sweatshirt so warm that it'll feel like you never left your bed. Arborwear creates a truly heavyweight and super warm sweatshirt with two layers of thick, 13 oz. 100% pre-shrunk Cotton Fleece and gusseted armpits for freedom of movement. Snap closures will keep your neck and chin warm while the oversized hood can fit over a hard hat or helmet.

### SPECS + FEATURES

- Sizes: S-3XL
- 2-13 oz. Layers of Pre-washed, 100% Cotton Fleece
- Oversized, 3-Piece Hood
- Snap Neck Collar, Gusseted Arms
- Vertical, Recessed Handwarmer Pouch
- Colors: Green or Chestnut (additional colors by special order)

SKU	PRODUCT
400240 S GREEN	Sweatshirt Double-thick Pullover Hooded - Green
400240103 M	Sweatshirt Double-thick Pullover Hooded - Green
400240103 L	Sweatshirt Double-thick Pullover Hooded - Green
400240103 XL	Sweatshirt Double-thick Pullover Hooded - Green
400240 S CHESTNUT	Sweatshirt Double-thick Pullover Hooded - Chestnut
400240200 M	Sweatshirt Double-thick Pullover Hooded - Chestnut
400240200 L	Sweatshirt Double-thick Pullover Hooded - Chestnut
400240200 XL	Sweatshirt Double-thick Pullover Hooded - Chestnut



GREEN

SUPER COZY; DON'T LEAVE LYING AROUND UNLESS YOU WANT IT KIDNAPPED!



CHESTNUT

# outerwear, first aid, education

PERSONAL PROTECTIVE EQUIPMENT / OUTERWEAR

## Arborwear Ascender Climbing Pants

Our **Ascender Pants** are made from a blend of 4-way stretch 89% Nylon and 11% Elasthane, with a Rugged Gusset™ crotch to ensure your legs are covered but free to move as they wish.

### SPECS + FEATURES

- Abrasion Resistant, Reinforced Knees
- Leg Opening Zips, Suspender Loops
- 4 Front and Rear Zip Pockets; Cargo Pocket with Zippered Utility Pocket
- Dual Layer Inner Ankles
- Teflon™ Fabric Protector Repels Water and Oil-based Liquids

SIZING: If you want a size not listed, we are happy to get you the size you need.

SKU	PRODUCT
106521606-30X32L	Pant Ascender Coal - 30X32
106521606-32X30	Pant Ascender Coal - 32X30
106521606-32X32	Pant Ascender Coal - 32X32
106521606-32X34L	Pant Ascender Coal - 32X34
106521606-34X30L	Pant Ascender Coal - 34X30
106521606-34X32L	Pant Ascender Coal - 34X32
106521606-34X34L	Pant Ascender Coal - 34X34
106521606-36X30L	Pant Ascender Coal - 36X30
106521606-36X32	Pant Ascender Coal - 36X32
106521606-36X34	Pant Ascender Coal - 36X34
106521606-40WX32L	Pant Ascender Coal - 40X32



GREAT LOOKING, SUPER FUNCTIONAL. PEOPLE WILL STOP YOU TO ASK YOU ABOUT YOUR PANTS.

## Arborwear Canopy Pants

Utilizing the popular 9 oz. 4-way Stretch Tech Nylon (89% Nylon/11% Elasthane), the **Canopy Pants** are super lightweight, breathable and bend along with your every move.

### SPECS + FEATURES

- 3-Piece Rugged Gusset™ Crotch
- Articulated Knees
- 4 Front and Rear Zip Pockets; Cargo Pocket with Zippered Utility Pocket
- Teflon™ Fabric Protector Repels Water and Oil-based Liquids

SIZING: If you want a size not listed, we are happy to get you the size you need.

SKU	PRODUCT
106533606-30WX32L	Pant Canopy Mens -Coal 30X32
106533606-32WX30L	Pant Canopy Mens -Coal 32X30
106533606-32WX32L	Pant Canopy Mens -Coal 32X32
106533606-32WX34L	Pant Canopy Mens -Coal 32X34
106533606-34WX30L	Pant Canopy Mens -Coal 34X30
106533606-34WX32L	Pant Canopy Mens -Coal 34X32
106533606-34WX34L	Pant Canopy Mens -Coal 34X34
106533606-34WX36L	Pant Canopy Mens -Coal 34X36
106533606-36WX32L	Pant Canopy Mens -Coal 36X32
106533606-36WX34L	Pant Canopy Mens -Coal 36X34
106533606-36WX36L	Pant Canopy Mens -Coal 36X36
106533-32WX30L	Pant Canopy Mens -Olive 32X30
106533-32WX32L	Pant Canopy Mens -Olive 32X32
106533-32WX36L	Pant Canopy Mens -Olive 32X36
106533-34WX34L	Pant Canopy Mens -Olive 34X34
106533-36WX34L	Pant Canopy Mens -Olive 36X34
106533-36WX36L	Pant Canopy Mens -Olive 36X36



COAL



OLIVE





## Arborwear Canopy Pants – Womens



Utilizing the popular 9 oz. 4-way Stretch Tech Nylon (89% Nylon/11% Elastane), the **Canopy Pants** are super lightweight, breathable and bend along with your every move.

### SPECS + FEATURES

- 3-Piece Rugged Gusset™ Crotch
- Articulated Knees
- 4 Lo-profile zippered thigh stash and welt back pockets with mesh lining
- Teflon™ Fabric Protector Repels Water and Oil-based Liquids
- Brush tricot waist liner for comfort
- Stowaway buttons for adjustable pant length

SIZING: If you want a size not listed, we are happy to get you the size you need.

SKU	PRODUCT
WOMENS CANOPY 10W 30	Pant Canopy Womens Coal – 10x30
WOMENS CANOPY 12X30	Pant Canopy Womens Coal – 12x30
WOMENS CANOPY 14W 28	Pant Canopy Womens Coal – 14x28
WOMENS CANOPY 14W 30	Pant Canopy Womens Coal – 14x30
WOMENS CANOPY 14W 32	Pant Canopy Womens Coal – 14x32



FOR THE COMFORTABLE, FIT  
AT YOUR HIPS KIND OF  
FEEL. YOU WILL BE HUNTING  
IN YOUR HAMPER FOR THESE!

## Arbpro EVO 2 Climbing Boots and Laces



A favorite among arborists worldwide for their slim and light build; 1.55 lbs per boot (depending on size). Custom made Vibram® New Mulaz 'High Grip' with 'Climbing Zone'. The upper is made of premium quality leather with rubber profile and the Event® 4 layer membrane offers maximum breathability and water resistance.

### SPECS + FEATURES

- Higher ankle support with a softer yet higher pad
- Stronger stitching and reinforced lacing system
- Includes a loop attachment point for knee ascenders (like the HAAS ClipNStep)
- Premium quality upper made with Perwanger leather with rubber reinforcement

SKU	PRODUCT
AP-SHEVO038	Arbpro EVO 2 Boot – (EU 38 / US 6)
AP-SHEVO039	Arbpro EVO 2 Boot – (EU 39 / US 7)
AP-SHEVO040	Arbpro EVO 2 Boot – (EU 40 / US 7.5)
AP-SHEVO041	Arbpro EVO 2 Boot – (EU 41 / US 8/8.5)
AP-SHEVO042	Arbpro EVO 2 Boot – (EU 42 / US 9)
AP-SHEVO042.5	Arbpro EVO 2 Boot – (EU 42.5 / US 9.5)
AP-SHEVO043	Arbpro EVO 2 Boot – (EU 43 / US 10)
AP-SHEVO044	Arbpro EVO 2 Boot – (EU 44 / US 10.5)
AP-SHEVO044.5	Arbpro EVO 2 Boot – (EU 44.5 / US 11)
AP-SHEVO045	Arbpro EVO 2 Boot – (EU 45 / US 11.5)
AP-SHEVO046	Arbpro EVO 2 Boot – (EU 46 / US 12)
AP-SHEVO047	Arbpro EVO 2 Boot – (EU 47 / US 13)
AP-LX210/OR	Arbpro EVO Boot – Rust Replacement Laces – 83"

PUDDLES... HA HA! GREAT  
BOOT, FEEL LIKE A GECKO  
WITH GREAT GRIPION!



## Arbortec Chainsaw Trousers Suspenders Heavy Duty Braces for Chainsaw Trousers

Chainsaw trousers by default are heavier than normal, due to the extra layers of protective padding, and this is further exacerbated when wearing Type C trousers (with rear protection as well as front). Unfortunately, this can lead to trouser slippage, which is extremely annoying – unless you wear a belt done up really tight, or even better, a set of these superb quality trouser suspenders. Over tightened belts are uncomfortable, and besides this, a belt can be quite incompatible with a climbing harness – so ditch the belt and go for a set of these superb braces today!

### SPECS + FEATURES

- Heavy-duty 5cm elastic webbing
- Soft comfort finish
- Steel adjusters
- Length: back piece: 13cm; Shoulder straps: adjustable from 45-85 cm

SKU	PRODUCT
AB321291	Arbortec Breatheflex Suspenders



# outerwear, first aid, education

PERSONAL PROTECTIVE EQUIPMENT / OUTERWEAR

## Arbpro Sigma Climbtch Trousers

Meet Arbpro's answer for a climber's demand for hi-flex and versatile climbing pants.

### SPECS + FEATURES

- Technical design able to provide maximum comfort while tree climbing
- Lightweight and comfortable due to 4-way stretch material
- Reinforcement areas that are mostly exposed to abrasion
- Slim design and excellent stretch provides superior movement in any position
- Ventilation via two wide zippers placed in the back of both legs.
- Integrated gaiters with hook create a barrier from ticks and dirt

SKU	PRODUCT
AP-CTB/GR/S/1	Arbpro Sigma Climbing Pant - Gray S1
AP-CTB/GR/S/2	Arbpro Sigma Climbing Pant - Gray S2
AP-CTB/GR/MD	Arbpro Sigma Climbing Pant - Gray M
AP-CTB/GR/L/1	Arbpro Sigma Climbing Pant - Gray L
AP-CTB/RO/M	Arbpro Sigma Climbing Pant - Red M
AP-CTB/RO/LG	Arbpro Sigma Climbing Pant - Red L

SLIM FIT; SHARP LOOKING TROUSER.



## Arbortec BreatheDRY Waterproof Smock



The Arbortec BreatheDRY Waterproof Smock is a lightweight technical garment with the arborist in mind. The hood has a wired peak, a bungee volume adjuster draw cord, and a large hook/loop storm flap. The sleeves are of generous length, and have inner soft cuffs with thumb loops, plus hook/loop tab fasteners to keep the watertight. Front kangaroo pouch pocket in the front accessed by long side zippers which acts as a ventilation point. Other sizes available, please give us a call!

### SPECS + FEATURES

- 100% waterproof & breathable
- Bendable hood margin to shield rain
- Helmet compatible hood flaps close with strong Velcro (when not needed the hood flaps can be folded and velcroed behind your head)
- Increased back length to shed water, and a high collar with waterproof zipper, inner placket, and neck protector.
- Underarm and pocket vent system
- EN 343 Class 3 (Hi Vis Orange or Yellow)

SKU	PRODUCT
AB345693-M	BreatheDRY Waterproof Jacket - Yellow M
AB345694-M	BreatheDRY Waterproof Jacket - Yellow L
AB345703-L	BreatheDRY Waterproof Jacket - Orange L
AB345704-OR-XL	BreatheDRY Waterproof Jacket - Orange XL
AB345719-BK-S	BreatheDRY Waterproof Jacket - Black S
AB345720-BK-M	BreatheDRY Waterproof Jacket - Black M
AB345721-BK-L	BreatheDRY Waterproof Jacket - Black L
AB345722-BK-XL	BreatheDRY Waterproof Jacket - Black XL



WHATEVERRRR WATER! TAKE THAT!

## Arbortec Kudu Plus Jacket



A casual, smart zip front jacket. An ideal extra layer for on or off the work site.

### SPECS + FEATURES

- Generous back and arm length for ease of movement
- Cuffs have integral thumb loops
- Large chest pocket will easily hold a smart phone
- Interior headphone access point
- Phone pocket with media port
- Large internal pockets with integrated key clip
- Knitted mélange (mixed) design

SKU	PRODUCT
AT4900-BL-S	Kudu Plus Jacket - Blue S
AT4900-BL-M	Kudu Plus Jacket - Blue M
AT4900-BL-L	Kudu Plus Jacket - Blue L
AT4900-BL-XL	Kudu Plus Jacket - Blue XL
AT4900-OR-S	Kudu Plus Jacket - Orange S
AT4900-OR-M	Kudu Plus Jacket - Orange M
AT4900-OR-L	Kudu Plus Jacket - Orange L
AT4900-OR-XL	Kudu Plus Jacket - Orange XL
AT4900-YE-S	Kudu Plus Jacket - Yellow S
AT4900-YE-M	Kudu Plus Jacket - Yellow M
AT4900-YE-L	Kudu Plus Jacket - Yellow L
AT4900-YE-XL	Kudu Plus Jacket - Yellow XL



SNUGGLY AND SHARP LOOKING





## Arbortec Scaffell Lite Class 2 Chainsaw Boots and Laces

**Scaffell Lite** is based on the same hand built concept as the previous model, and in addition includes a new 4 density sole unit, and a composite mid-sole system for the perfect balance of stability, flexibility, weight and longevity. Guaranteed to keep your feet dry. Comes with removable and replaceable foot bed, spare laces and a complimentary pair of **Scaffell Lite** technical socks. Black replacement laces are also available for **Scaffell Lite Chainsaw Boots**

### SPECS + FEATURES

- 24m/s chainsaw protection –vital for professional users –EN ISO 17249 Class 2
- Steel toe cap & composite pierce resistant mid-sole
- 100% Waterproof and breathable with BreatheDRY lining
- New 4D sole unit with Vibram out-sole
- 3 ZONE™ Lacing system provides ultimate support with speed roller section, heel stabilization zone and open top hooks for hassle free tie off
- Simple.i-fit™ – foot hugging concept, with movable inner tongue, deep heel grip and close fitting elasticized protection gaiter.

SKU	SIZE US	PRODUCT
010216	7	Boot Scaffell Lite Chainsaw Green
010217	7.5	Boot Scaffell Lite Chainsaw Green
010411	8	Boot Scaffell Lite Chainsaw Green
010220	9	Boot Scaffell Lite Chainsaw Green
010222	10	Boot Scaffell Lite Chainsaw Green
010224	11	Boot Scaffell Lite Chainsaw Green
010225	11.5	Boot Scaffell Lite Chainsaw Green
010226	12	Boot Scaffell Lite Chainsaw Green
010227	13	Boot Scaffell Lite Chainsaw Green
010228	14	Boot Scaffell Lite Chainsaw Green
011558	8	Boot Scaffell Lite Chainsaw Red
011559	9	Boot Scaffell Lite Chainsaw Red
011560	10	Boot Scaffell Lite Chainsaw Red
011561	11	Boot Scaffell Lite Chainsaw Red
011562	11.5	Boot Scaffell Lite Chainsaw Red
011563	12	Boot Scaffell Lite Chainsaw Red
011564	13	Boot Scaffell Lite Chainsaw Red
012330	6	Boot Scaffell Lite Chainsaw Orange
011755	7	Boot Scaffell Lite Chainsaw Orange
012469	7.5	Boot Scaffell Lite Chainsaw Orange
011565	8	Boot Scaffell Lite Chainsaw Orange
011566	9	Boot Scaffell Lite Chainsaw Orange
011567	10	Boot Scaffell Lite Chainsaw Orange

SKU	SIZE US	PRODUCT
011568	11	Boot Scaffell Lite Chainsaw Orange
011569	11.5	Boot Scaffell Lite Chainsaw Orange
011570	12	Boot Scaffell Lite Chainsaw Orange
011571	13	Boot Scaffell Lite Chainsaw Orange
010245	6	Boot Scaffell Lite Chainsaw Blue
010247	7	Boot Scaffell Lite Chainsaw Blue
010248	7.5	Boot Scaffell Lite Chainsaw Blue
010249	8	Boot Scaffell Lite Chainsaw Blue
010251	9	Boot Scaffell Lite Chainsaw Blue
010253	10	Boot Scaffell Lite Chainsaw Blue
010255	11	Boot Scaffell Lite Chainsaw Blue
010256	11.5	Boot Scaffell Lite Chainsaw Blue
010257	12	Boot Scaffell Lite Chainsaw Blue
010258	13	Boot Scaffell Lite Chainsaw Blue
010259	14	Boot Scaffell Lite Chainsaw Blue
010230	6	Boot Scaffell Lite Chainsaw Black
010232	7	Boot Scaffell Lite Chainsaw Black
010233	7.5	Boot Scaffell Lite Chainsaw Black
010234	8	Boot Scaffell Lite Chainsaw Black
010236	9	Boot Scaffell Lite Chainsaw Black
010238	10	Boot Scaffell Lite Chainsaw Black
010240	11	Boot Scaffell Lite Chainsaw Black
010241	11.5	Boot Scaffell Lite Chainsaw Black
010242	12	Boot Scaffell Lite Chainsaw Black
010243	13	Boot Scaffell Lite Chainsaw Black
010244	14	Boot Scaffell Lite Chainsaw Black
011551	8	Boot Scaffell Lite Chainsaw Brown
011552	9	Boot Scaffell Lite Chainsaw Brown
011553	10	Boot Scaffell Lite Chainsaw Brown
011554	11	Boot Scaffell Lite Chainsaw Brown
011555	11.5	Boot Scaffell Lite Chainsaw Brown
011556	12	Boot Scaffell Lite Chainsaw Brown
011557	13	Boot Scaffell Lite Chainsaw Brown
012456	UNIVERSAL	Scaffell Boot Replacement Laces Black



FEATURES GALORE AND OH, WE'VE GOT YOUR COLOR!

# outerwear, first aid, education

PERSONAL PROTECTIVE EQUIPMENT / OUTERWEAR

## Arbortec Forestwear Xpert Socks



Heavy duty work sock, for extreme outdoor wear. Our technical socks are made from a blend of Thermocool, Merino Wool, and Lycra for superb fit, moisture wicking capabilities, and thermal regulation.

### SPECS + FEATURES

- Lo-Rise sock features anatomically y-shaped heel support
- 3 layers in metatarsal zone for improved circulation
- Softened instep to protect against blisters and bruises with vent panels and channels around tibia for temperature control
- Moisture wicking fibers on sides and tibia
- Extra flat toe seam for comfort and reinforced toe & heel for durability
- Suitable for working in cold temperatures

SKU	PRODUCT
AB332385	Boot Sock Lo-Rise Orange – S
AB332386	Boot Sock Lo-Rise Orange – M
AB332387	Boot Sock Lo-Rise Orange – L
AB332388	Boot Sock Lo-Rise Orange – XL
AB332528	Boot Sock Hi-Rise Green – S
AB332529	Boot Sock Hi-Rise Green – M
AB332530	Boot Sock Hi-Rise Green – L
AB332531	Boot Sock Hi-Rise Green – XL



## ERB Mesh Vest Class 2 Breakaway



100% polyester mesh. Hook/loop front closure with 2 interior waist pockets.

### SPECS + FEATURES

- ANSI 107 Type R, Class 2
- 5 Point Break-Away vest
- 2 interior waist pockets
- AwareLite reflective trim

SKU	PRODUCT
61100	ERB Mesh Vest Class 2 Breakaway – Medium
61101	ERB Mesh Vest Class 2 Breakaway – Large
61102	ERB Mesh Vest Class 2 Breakaway – XLarge
61103	ERB Mesh Vest Class 2 Breakaway – XXLarge

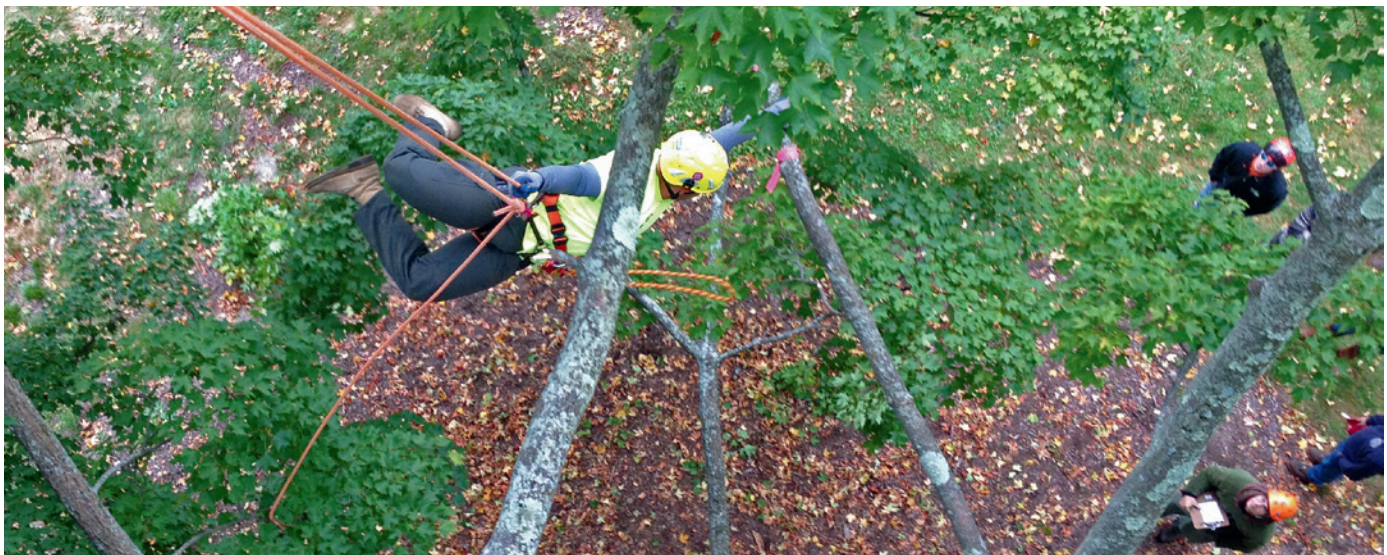



## Weaver First Aid Blood Stopper Kit

A combination of Weaver's First Aid Bag and Blood stopper.

### SPECS + FEATURES

- First Aid Bag attaches to harness with a nickel-plated snap; Handy 1,000-denier polyester bag; Dimensions: 4" W x 5-1/2" H x 1-1/2" D
- Blood Stopper -Non-stick, expandable pad provides wound or burn coverage; Features an additional stretch gauze roll that can be used as a pressure bandage; Can also be used as an arm sling

SKU	PRODUCT
08-07170	First Aid Bag Only
08-07168	Blood Stopper Dressing Only



## Edelrid TREE REX First Aid Bag

First Aid Bag for the TREE REX tree-climbing harness.

### SPECS + FEATURES

- Ideal for accommodating emergency equipment such as blood stoppers, tourniquets, and compression bandages.
- Includes attachment straps.

SKU	PRODUCT
887180000170	Edelrid TREE REX First Aid Bag

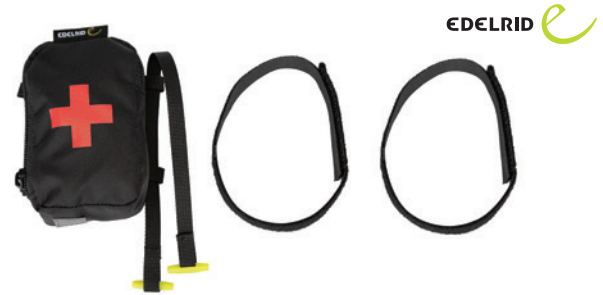

## BUCK First Aid Blood Stopper Pouch

### SPECS + FEATURES

- Nylon outside with heavy duty velcro closure
- Quickly attaches to any harness with a snap
- Includes 1 large, one time use blood stopper used to control bleeding until the victim can be administered first aid on the ground

SKU	PRODUCT
4600R3S3 RED	First Aid Blood Stopper Pouch - Red
4600S3Y	First Aid Blood Stopper Pouch - Yellow



## North® Logger's First Aid Kit

First Aid Kit contains a variety of the most commonly used first aid supplies for the logging industry. Steel case with handle: 6-5/16" X 9-1/16" X 2-3/8" with wall bracket to mount. Meets OSHA 1910.266 standard.

### SPECS + FEATURES

- Bandages/Pads: (4) 4" x 4" Gauze pads, (2) 8" x 10" Bandage compresses, (2) 2" x 6 yd Gauze bandage, (2) Triangular bandages, (2) 3" x 5 yd Elastic bandage
- (16) 1" x 3" Plastic strips and (2) 1/2" x 2 1/2 yd Tape
- (10) Wound wipes
- (1) Scissors & forceps
- (1) 526" x 84" silver rescue blanket
- (1) Gloves
- (1) CPR mask
- (1) Wire splint
- (1) First aid booklet

SKU	PRODUCT
HON3516L	Logger's First Aid Kit





# outerwear, first aid, education

PERSONAL PROTECTIVE EQUIPMENT / FIRST AID

## Timber Wolf Waterless Hand Cleaner



**Timber Wolf Waterless Hand Cleaner** is a citrus based, biodegradable, environmentally safe, waterless hand cleaner. Our product contains no pumice, petroleum, or mineral solvents. **Timber Wolf** is pH balanced and contains the finest moisturizing agents plus aloe vera to help heal cuts and scratches and skin irritation.

### SPECS + FEATURES

- Removes residue after field dressing, blood and odor, fish oil and scales, fish odor, tree sap, creosote & pine tar, grease & oil, fiber optic cable jelly, silicone gel, c-cement, kopper bond, pipe dope, soil & grass stains, paint, grease & oil, adhesives, ink, asphalt & tar.
- **Prevents and Relieves Poison Ivy/Oak Symptoms**
- Repels Mosquitoes when used as a lotion on skin

SKU	PRODUCT
HE2000	Timber Wolf Waterless Hand Cleaner - 1 Gallon
HE2008	Timber Wolf Waterless Hand Cleaner - 8 oz
HE2016	Timber Wolf Waterless Hand Cleaner - 16 oz
HE1700	Timber Wolf Cleanser - Replacement Pump

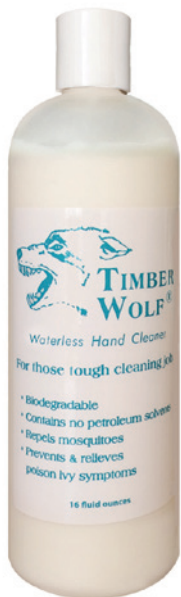

A VERY VERSATILE  
PRODUCT, AND YES,  
IT TRULY WORKS!





## ANSI Z133.1 Standards Book

The **Z133 Safety Standard** was developed for the arboriculture industry under the procedures of the ANSI. This publication provides an essential guide for federal, state, and municipal authorities in drafting regulations.

### SPECS + FEATURES

- General safety
- Electrical hazard
- Use of vehicles and mobile equipment
- Portable power hand tools
- Hand tools and ladders
- Climbing
- Work procedures

A STAPLE FOR EVERY  
ARBORIST AND COMPANY!

SKU	PRODUCT
P1208 2017	ANSI Z133.1 Standards Book

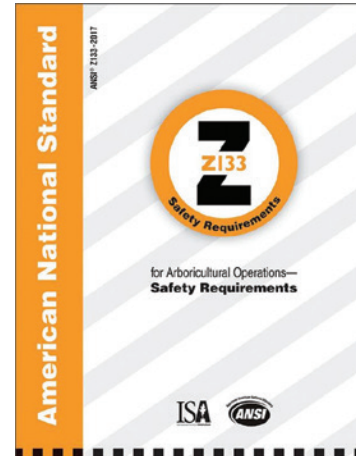

## Tree Climber's Companion by Jeff Jepson

A field-sized reference and safety manual for climbers featuring illustrations by Bryan Kotwica. The *Tree Climber's Companion*, en Espanol: *El Compañero del Trepador*. Un manual de referencia y entrenamiento para trepadores profesionales.

### SPECS + FEATURES

- Tools of the Trade
- Revised Climbing System (PREP)
- "Tying In" procedure
- Climbing with climbing spurs
- Ascending and descending techniques
- More knots (including the French Prusiks)
- Safety standards and more

SKU	PRODUCT
TREC	<i>Tree Climber's Companion</i> by Jeff Jepson – English
TRCS	<i>Tree Climber's Companion</i> by Jeff Jepson – Spanish

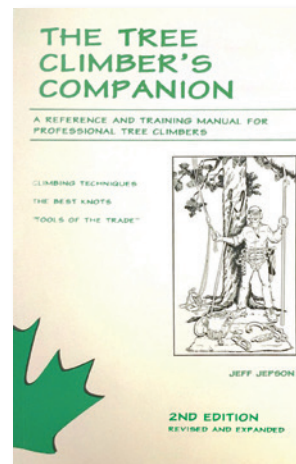

## To Fell a Tree – A Complete Guide to Tree Felling and Woodcutting Methods by Jeff Jepson

Written for both the professional and occasional tree cutter, this book provides essential information to ensure the safety and success of any tree felling and woodcutting operation. Easy to follow step by step instructions. Publisher: Beaver Tree Publishing (2009) Code: ISBN: 9780615338798

### TOPICS INCLUDE:

- Preparations before the work begins
- Felling a tree using a three step procedure
- Felling difficult trees
- Limbing and bucking the tree (snedding and cross-cutting)
- Potential work hazards
- Chain saw safety
- Personal protective equipment
- Protecting people and property
- Felling storm damaged trees
- Moving limbs and logs
- Methods for splitting and stacking wood

SKU	PRODUCT
TOFE	<i>To Fell A Tree Book</i> by Jeff Jepson

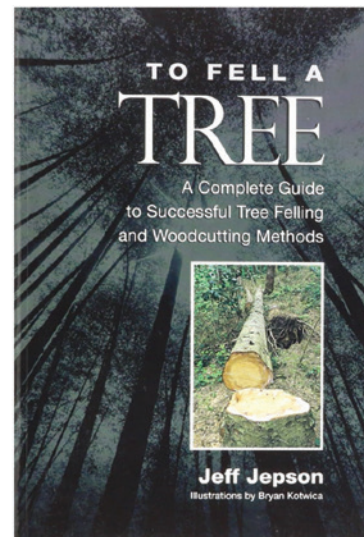



PERSONAL PROTECTIVE EQUIPMENT / EDUCATION

## ***Knots at Work: A Field Guide for the Modern Arborist* by Jeff Jepson**

Jepson's latest field guide provides more than 50 different knots in this 184-page, soft cover book. Highlighting knot knowledge in two important conceptual ways: time-knot construction (tying the knots) and knot application (using the knots). This information can be quickly grasped, because of Brian Kotwica's excellent illustrations, easy-to-read text, and unique cross-reference format. Its compact size will encourage its use out in the field where it's needed most.

Publisher: Beaver Tree Publishing Code: ISBN: 97897266796 (2014)

Emphasizing two important concepts:

- How to correctly tie the knots
- Right application for the knot

SKU	PRODUCT
KAW	<i>Knots At Work</i> Book

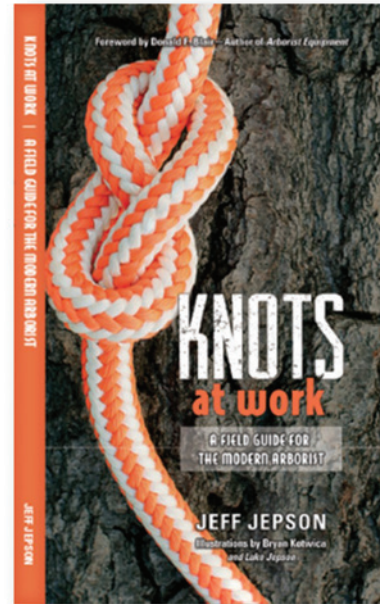
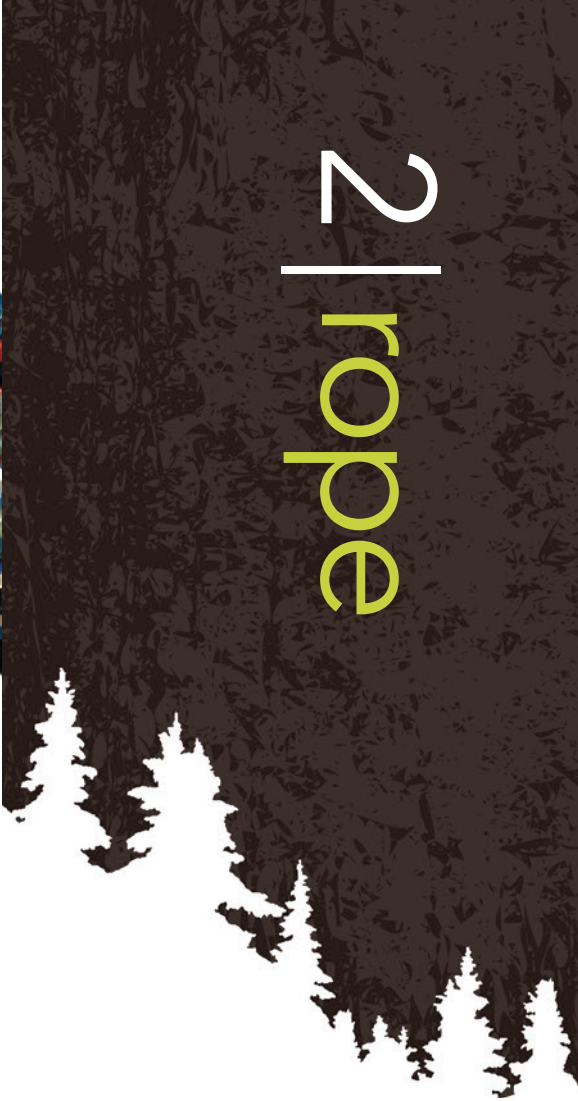

Photo by Tom Ingersoll





# 2 | rope







































CLIMBING LINES .....	56
RIGGING LINES .....	70
PRUSIKS .....	78
ROPE ACCESSORIES .....	83

# climbing lines cross reference

	NAME	STRAND CONSTRUCTION	DIAMETER (Inches/Millimeters)		TENSILE STRENGTH	LBS PER 100'	ELONGATION AT 10%	SPLICEABLE*	STATIC	DYNAMIC	MANUFACTURER	PAGE
24-32 STRAND	 HyperClimb	24	29/64	11.7	6,500	6.5	1.3	HAND	•	•	SAMSON	56
	 Voyager™ Cool	24	15/32	11.8	8,000	6.5	3	HAND	•	•	SAMSON	56
	 Vortex™ Hot	24	1/2	12.7	7,500	7.6	3	HAND	•	•	SAMSON	56
	 Velocity™ Hot	24	7/16	11	6,000	5.6	3	HAND	•	•	SAMSON	57
	 <b>Tachyon FrostBight</b>	<b>24</b>	<b>7/16</b>	<b>11.5</b>	<b>5,500</b>	<b>6.3</b>	<b>2.2</b>	<b>HAND</b>	<b>•</b>	<b>•</b>	<b>TEUFELBERGER</b>	<b>57</b>
	 Tachyon Ash	24	7/16	11.5	5,500	6.3	2.2	HAND	•	•	TEUFELBERGER	57
	 Tachyon Orange	24	7/16	11.5	5,500	6.3	2.2	HAND	•	•	TEUFELBERGER	57
	 Tachyon Pink	24	7/16	11.5	5,500	6.3	2.2	HAND	•	•	TEUFELBERGER	58
	 Woodpecker – Orange and Violet	24	15/32	11.7	5,620	6.2	2.1	SEWN	•	•	EDELRID	58
	 Direction Up	24	1/2	13	7,643	7.7	2.8	HAND	•	•	EDELRID	58
	 Scion Blue 11.5 mm	24	7/16	11.7	6,740	6.2	3.8	SEWN	•	•	STERLING	58
	 Scion Blue 12.5 mm	24	1/2	12.5	7,193	7.2	3.3	HAND	•	•	STERLING	59
	 drenaLINE and drenaLINE Pink	32	15/32	11.8	7,870	6.5	2.3	HAND	•	•	TEUFELBERGER	59
	 Blue Moon	24	7/16	11.7	6,500	6.5	1.4	HAND	•	•	YALE	59
	 Imori – Green and Orange	24	1/2	12	6,200	7	2.4	HAND	•	•	YALE	60
 Blaze	24	7/16	11.4	5,600	6	1.4	HAND	•	•	YALE	60	
 Arborist-24™ Yellow Jacket	24	7/16	11.1	7,000	5.6	5	HAND	•	•	PELICAN	60	
16-STRAND	 ArborMaster® Hawkeye	16	1/2	13	6,500	7.7	3	HAND	•	•	SAMSON	61
	 ArborMaster® Blue Streak	16	1/2	13	6,500	7.7	3	HAND	•	•	SAMSON	61
	 ArborMaster® Red/Black/White	16	1/2	13	6,500	7.7	3	HAND	•	•	SAMSON	61
	 Safety Blue – Hi-Vee	16	1/2	13	5,800	7.1	2.2	HAND	•	•	TEUFELBERGER	61
	 Safety Blue – Ultra-Vee	16	1/2	13	5,800	7.1	3	HAND	•	•	TEUFELBERGER	62
	 Safety Blue – White	16	1/2	13	5,800	7.1	3	HAND	•	•	TEUFELBERGER	62
	 XTC Fire	16	1/2	13	6,200	7.5	1.4	HAND	•	•	YALE	62
	 XTC Plus	16	1/2	13	6,200	7.5	1.4	HAND	•	•	YALE	62
	 XTC 16 Spearmint	16	1/2	13	6,200	7.5	1.4	HAND	•	•	YALE	63
	 XTC 16 White	16	1/2	13	6,200	7.5	1.4	HAND	•	•	YALE	63
	 X-P*e	16	1/2	12	5,400	7.7	2.2	HAND	•	•	EDELRID	63
	 <b>Green/Black/White</b>	<b>16</b>	<b>1/2</b>	<b>13</b>	<b>7,150</b>	<b>8.4</b>	<b>2.8</b>	<b>HAND</b>	<b>•</b>	<b>•</b>	<b>PELICAN</b>	<b>63</b>
	 Arborist-16™ Hi-Vis	16	1/2	13	7,150	8.4	2.8	HAND	•	•	PELICAN	64
12-STRAND	 Arbor-Plex	12	1/2	13	6,000	6.8	3	NO	•	•	SAMSON	65
	 True-Blue	12	1/2	13	7,300	8.8	2.6	NO	•	•	SAMSON	65
	 True-White	12	1/2	13	7,300	8.8	2.6	NO	•	•	SAMSON	65
	 XTC 12 White	12	1/2	13	6,000	6.7	2.2	NO	•	•	YALE	65
STATIC KERNMANTLE	 Safari Kernmaster	48	7/16	11.7	7,100	5.5	3	SEWN	•	•	YALE	67
	 Scandere – Red, Yellow, and Purple	48	7/16	11.7	7,100	6.5	3	SEWN	•	•	YALE	67
	 HTP Static	44	7/16	11	6,856	6.5	2.5	SEWN	•	•	STERLING	67
	 WorkPro	32	1/2	12.5	10,565	7.4	3.2	SEWN	•	•	STERLING	67
	 Mercury	32	7/16	11	8,600	6	3.7	SEWN	•	•	SAMSON	68
	 Platinum® Protect PES/PA	32	7/16	10.5	6,290	5.2	2	SEWN	•	•	TEUFELBERGER	68
	 xSTATIC	32	7/16	11.7	7,190	7.1	1.4	SEWN	•	•	TEUFELBERGER	68
	 KM-III Max	32	7/16	11	7,900	19	1	SEWN	•	•	TEUFELBERGER	68
	 Static Low Stretch	32	7/16	11	7,868	5.4	1.8	SEWN	•	•	EDELRID	69
	 Static Master 7/16"	32	7/16	11	7,000	5.7	4.3	SEWN	•	•	PELICAN	69
	 Static Master 1/2"	32	1/2	13	9,807	7.5	4.3	SEWN	•	•	PELICAN	69



# rigging lines cross reference

	NAME	STRAND CONSTRUCTION	DIAMETER (Inches/Millimeters)		TENSILE STRENGTH	LBS PER 100'	ELONGATION AT 10%	SPLICEABLE*	USE	MANUFACTURER	PAGE
DOUBLE-BRAID	 Stable Braid	20	1/2	13	10,400	1.1	8.2	•	Rigging	Samson	70
	 Stable Braid	20	9/16	14	13,300	1.1	11	•	Rigging	Samson	70
	 Stable Braid	20	5/8	16	16,300	1.1	14	•	Rigging	Samson	70
	 Stable Braid	20	3/4	19	20,400	1.1	18	•	Rigging	Samson	70
	 Polydyne	24	1/2	13	11,000	3	7.6	•	Rigging	Yale	71
	 Polydyne	24	9/16	14	15,000	3	9.7	•	Rigging	Yale	71
	 Polydyne	24	5/8	16	18,900	3	13.6	•	Rigging	Yale	71
	 Portland Braid	24	5/8	16	14,900	1	13	•	Rigging	Yale	71
	 Portland Braid	24	3/4	19	18,000	1	16.4	•	Rigging	Yale	71
	 Sirius	32	15/32	12	7,860	6.9	N/A	•	Rigging	Teufelberger	72
	 Sirius	32	9/16	14	11,700	10.2	N/A	•	Rigging	Teufelberger	72
	 Sirius	32	5/8	16	14,160	12.4	N/A	•	Rigging	Teufelberger	72
	 Sirius	32	11/16	18	17,300	15.3	N/A	•	Rigging	Teufelberger	72
	 Sirius	32	13/16	20	19,700	19.2	N/A	•	Rigging	Teufelberger	72
	 Atlas	24	1/2	13	11,500	4.1	7.9	•	Rigging	Sterling	73
	 Atlas	24	9/16	14	13,750	4.5	8.9	•	Rigging	Sterling	73
	 Atlas	24	5/8	16	19,400	4.5	13.5	•	Rigging	Sterling	73
	 Matador	24	5/8	16	16,000	7.0	13.1	•	Rigging	Pelican	73
	 Matador	24	3/4	19	25,000	7.0	17.2	•	Rigging	Pelican	73
	 Matador	24	1	25.5	45,000	7.0	29.7	•	Rigging	Pelican	73
12-STRAND - HOLLOW BRAID	 AmSteel® Blue	12	5/16	8	13,700	0.5	2.7	•	Winch/Sling	Samson	74
	 AmSteel® Blue	12	3/8	9.5	19,600	0.5	3.4	•	Winch/Sling	Samson	74
	 AmSteel® Blue	12	7/16	11	23,900	0.5	4.5	•	Winch/Sling	Samson	74
	 AmSteel® Blue	12	1/2	13	34,000	0.5	5.9	•	Sling	Samson	74
	 Tenex-TEC	12	3/8	9.5	6,100	1.4	4.3	•	Sling	Samson	75
	 Tenex-TEC	12	1/2	13	13,100	1.4	9.2	•	Sling	Samson	75
	 Tenex-TEC	12	5/8	16	18,800	1.4	14.8	•	Sling	Samson	75
	 Tenex-TEC	12	3/4	19	24,800	1.4	17.7	•	Sling	Samson	75
	 tREX	12	5/8	16	14,800	2.3	13.7	•	Sling	Teufelberger	75
	 tREX	12	7/8	22	28,700	2.3	23.3	•	Sling	Teufelberger	75
	 Ultrax	12	3/8	9.5	20,000	8	3.5	•	Winch Line	Yale	76
	 Arbor-Plex	12	5/8	16	9,000	3	12		Rigging	Samson	76
	 Arbor-Plex	12	3/4	19	12,000	3	16.2		Rigging	Samson	76
3-STRAND	 ProMaster	3	1/2	13	5,700	2	7	•	Rigging	Samson	77
	 ProMaster	3	5/8	16	7,700	2	10	•	Rigging	Samson	77
	 ProMaster	3	3/4	19	10,000	2	14	•	Rigging	Samson	77

SOME ROPES ON THE FOLLOWING PAGES WILL HAVE SKUS IDENTIFIED FOR SPLICES. IF NOT INDICATED, SPLICES AND SEWN EYES CAN BE ADDED BY SPECIAL ORDER.

# climbing lines

## Samson HyperClimb™ Cool NEW

### SPECS

Diameter	29/64"   11.7 mm
ABS	6,500 lbs   2,900 kg
Construction	24-Strand Double-Braid
Cover/Core	Polyester/Polyester
Elongation at 10%	1.3%
Weight	6.5 lbs per 100'   9.7 kg per 100 m
Spliceable	Yes, Hand



### FEATURES

- Great for moving (MRS) and stationary rope systems (SRS)
- Excellent knot-holding capability
- Exceptional access line
- Works well with hardware

SKU	FT	PRODUCT
458032001560	150'	HyperClimb Cool - 29/64"   11.7 mm
458032002060	200'	HyperClimb Cool - 29/64"   11.7 mm
458032001560100	150'	HyperClimb Cool w/ Tight Eye Splice
458032002060100	200'	HyperClimb Cool w/ Tight Eye Splice

Engineered for use with both moving and stationary rope systems, **HyperClimb** has excellent hand, is durable, lightweight, and is perfect for long ascents. It's an excellent companion for climbers of all skill levels.

## Samson Voyager™ Cool

### SPECS

Diameter	15/32"   11.8 mm
ABS	8,000 lbs   3,629 kg
Construction	24-Strand Double-Braid
Cover/Core	Polyester/Nylon
Elongation at 10%	3%
Weight	6.5 lbs per 100'   3 kg per 30 m
Spliceable	Yes, Hand



### FEATURES

- Constructed with a stabilized nylon core and polyester cover
- This light and flexible rope has superior knot-holding ability
- Works very well with arborists' hardware
- Excellent footlocking line

SKU	FT	PRODUCT
011101	BULK	Voyager Cool - 15/32"   11.8 mm
VOY1532120	120'	Voyager Cool - 15/32"   11.8 mm
VOY1532150	150'	Voyager Cool - 15/32"   11.8 mm
VOY1532200	200'	Voyager Cool - 15/32"   11.8 mm
VOY1532600	600'	Voyager Cool - 15/32"   11.8 mm
VOY1532150S	150'	Voyager Cool w/ Tight Eye Splice

The latest addition to **Samson's V-Series** of premium climbing lines. **Velocity**, **Vortex**, and **Voyager** all combine high-strength performance with light weight, flexibility, and ease of use.

## Samson Vortex™ Hot

### SPECS

Diameter	1/2"   12.7 mm
ABS	7,500 lbs   3,400 kg
Construction	24-Strand Double-Braid
Cover/Core	Polyester/Nylon
Elongation at 10%	3%
Weight	7.6 lbs per 100'   3.6 kg per 30 m
Spliceable	Yes, Hand



### FEATURES

- Excellent knot-holding capability
- Full 12.7 mm for easy handling
- Works well with hardware

SKU	FT	PRODUCT
007861	BULK	Vortex Hot - 1/2"   12.7 mm
VTH12120	120'	Vortex Hot - 1/2"   12.7 mm
VTH12150	150'	Vortex Hot - 1/2"   12.7 mm
VTH12200	200'	Vortex Hot - 1/2"   12.7 mm
VTH12600	600'	Vortex Hot - 1/2"   12.7 mm
VTH12150S	150'	Vortex Hot w/ Tight Eye Splice

**Vortex** the lightest premium climbing line available in the 1/2" size. A 24-Strand cover like **Samson's Velocity**, but it's larger diameter offers a larger, better grip. **Vortex** works well with hardware, handles knots, and is great for footlocking. **Vortex** is part of the **Samson V-Series Premium Climbing Line** series.

VORTEX COOL ALSO AVAILABLE



## Samson Velocity™ Hot

### SPECS

Diameter	7/16"   11.1 mm
ABS	6,000 lbs   2,727 kg
Construction	24-Strand Double-Braid
Cover/Core	Polyester/Nylon
Elongation at 10%	3%
Weight	5.6 lbs per 100'   2.5 kg per 30 m
Spliceable	Yes, Hand



**Velocity** is a climbing line of champions. One of the lightest climbing lines in the 7/16" (11 mm) size, **Velocity** has excellent knot-holding ability, works well with hardware, and is great for footlocking.



### FEATURES

- Using Samson's "Sure Grip" technology, which provides a "broken-in feeling" right out of the bag.
- Excellent knot-holding capability
- Works well with hardware

SKU	FT	PRODUCT
010779	BULK	Velocity Hot - 7/16"   11.1 mm
SH716120	120'	Velocity Hot - 7/16"   11.1 mm
SH716150	150'	Velocity Hot - 7/16"   11.1 mm
SH716200	200'	Velocity Hot - 7/16"   11.1 mm
SH716600	600'	Velocity Hot - 7/16"   11.1 mm

## Teufelberger Tachyon FrostBight

### SPECS

Diameter	7/16"   11.5 mm
ABS	5,500 lbs   2,495 kg
Construction	24-Strand Double-Braid
Cover/Core	Polyester/Nylon
Elongation at 10%	2.2%
Weight	6.3 lbs per 100'   2.86 kg per 30 m
Spliceable	Yes, Hand, or spLIFE



**EXCLUSIVE PRODUCT Tachyon Frostbight** is a versatile, lightweight, 11.5 mm climbing line with a unique blue color pattern from **Teufelberger**; design input from Ocean's Eric Whipple. The line is firm yet flexible and significantly improves friction hitch performance without "bulging." [Certified EN 1891 A, ANSI Z.133]

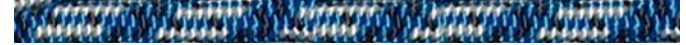

### FEATURES

- Solid dual purpose line (MRS, SRS)
- Excellent compatibility with hardware and ascenders
- Low stretch at low loads for less bounce while climbing
- High stretch at high loads to minimize impact in the event of a fall

SKU	FT	PRODUCT
010353	BULK	Tachyon Frostbight - 7/16"   11.5 mm
010346	120'	Tachyon Frostbight - 7/16"   11.5 mm
C4900-11-00150	150'	Tachyon Frostbight - 7/16"   11.5 mm
010348	200'	Tachyon Frostbight - 7/16"   11.5 mm
010349	600'	Tachyon Frostbight - 7/16"   11.5 mm
011856	120'	Tachyon Frostbight w/ Tight Eye Splice
011610	150'	Tachyon Frostbight w/ Tight Eye Splice
011857	200'	Tachyon Frostbight w/ Tight Eye Splice

## Teufelberger Tachyon Ash

### SPECS

Diameter	7/16"   11.5 mm
ABS	5,500 lbs   2,495 kg
Construction	24-Strand Double-Braid
Cover/Core	Polyester/Nylon
Elongation at 10%	2.2%
Weight	6.3 lbs per 100'   2.86 kg per 30 m
Spliceable	Yes, Hand, or spLIFE



**Tachyon** is a versatile, lightweight, 11.5 mm climbing line from **Teufelberger**. Firm yet flexible and significantly improves friction hitch performance without "bulging." [Certified EN 1891 A, ANSI Z.133]



### FEATURES

- Solid dual purpose line (MRS, SRS)
- Excellent compatibility with hardware and ascenders
- Great choice for MRS and SRS climbing systems
- Low stretch at low loads for less bounce while climbing
- High stretch at high loads to minimize impact in the event of a fall

SKU	FT	PRODUCT
C3248-11-00150	150'	Tachyon Ash - 7/16"   11.5 mm
012890	150'	Tachyon Ash w/ Tight Eye Splice
012897	200'	Tachyon Ash w/ Tight Eye Splice

## Teufelberger Tachyon Orange

### SPECS

Diameter	7/16"   11.5 mm
ABS	5,500 lbs   2,495 kg
Construction	24-Strand Double-Braid
Cover/Core	Polyester/Nylon
Elongation at 10%	2.2%
Weight	6.3 lbs per 100'   2.86 kg per 30 m
Spliceable	Yes, Hand, or spLIFE



**Tachyon** is a versatile, lightweight, 11.5 mm climbing line from **Teufelberger**. Firm yet flexible and significantly improves friction hitch performance without "bulging." [Certified EN 1891 A, ANSI Z.133]



### FEATURES

- Solid dual purpose line (MRS, SRS)
- Excellent compatibility with hardware and ascenders
- Great choice for MRS and SRS climbing systems
- Low stretch at low loads for less bounce while climbing
- High stretch at high loads to minimize impact in the event of a fall

SKU	FT	PRODUCT
006465	BULK	Tachyon Orange - 7/16"   11.5 mm
007210	120'	Tachyon Orange - 7/16"   11.5 mm
32361100150	150'	Tachyon Orange - 7/16"   11.5 mm
007212	200'	Tachyon Orange - 7/16"   11.5 mm
007213	600'	Tachyon Orange - 7/16"   11.5 mm

# climbing lines

ROPE / CLIMBING LINES / 24-32-STRAND

## Teufelberger Tachyon Pink

### SPECS

<b>Diameter</b>	7/16"   11.5 mm
<b>ABS</b>	5,500 lbs   2,495 kg
<b>Construction</b>	24-Strand Double-Braid
<b>Cover/Core</b>	Polyester/Nylon
<b>Elongation at 10%</b>	2.2%
<b>Weight</b>	6.3 lbs per 100'   2.86 kg per 30 m
<b>Spliceable</b>	Yes, Hand, or sPLIFE



### FEATURES

- Hi-visibility in trees
- Solid dual purpose line (MRS, SRS)
- Excellent compatibility with hardware and ascenders
- Great choice for MRS and SRS climbing systems
- Low stretch at low loads for less bounce while climbing
- High stretch at high loads to minimize impact in the event of a fall

SKU	FT	PRODUCT
009229	BULK	Tachyon Pink - 7/16"   11.5 mm

**Tachyon** is a versatile, lightweight, 11.5 mm climbing line from **Teufelberger**. Firm yet flexible and significantly improves friction hitch performance without "bulging." [Certified EN 1891 A, ANSI Z.133]

## Edelrid Woodpecker

### SPECS

<b>Diameter</b>	15/32"   11.7 mm
<b>ABS</b>	5,620 lbs   2,549 kg
<b>Construction</b>	24 Stand Kernmantle twined sheath
<b>Cover/Core</b>	Polyester/Polyamide
<b>Elongation at 10%</b>	2.1%
<b>Weight</b>	6.28 lbs per 100'   2.85 kg per 30 m
<b>Spliceable</b>	Yes, Hand



### FEATURES

- 24-Strand sheath texture ensures a sure grip
- Bright colors ensure good visibility
- Thermo Shield treatment for perfect handling
- Twined and shrunk polyester sheath construction for maximum abrasion resistance and minimal shrinkage braided core
- Special kernmantle braiding in the core for maximum dimensional stability and excellent splice properties

SKU	FT	PRODUCT
832350452490	150'	Woodpecker Orange - 15/32"   11.7 mm
832350602490	200'	Woodpecker Orange - 15/32"   11.7 mm
832350458020	150'	Woodpecker Violet - 15/32"   11.7 mm
832350608020	200'	Woodpecker Violet - 15/32"   11.7 mm

Premium tree climbing rope with especially soft grip and excellent splice properties. Perfectly suited for use with self-braking descenders. Made in Germany. ANSI Z.133 certified

## Edelrid Direction Up

### SPECS

<b>Diameter</b>	1/2"   13 mm
<b>ABS</b>	7,643 lbs   3,467 kg
<b>Construction</b>	24-Strand Double-Braid
<b>Cover/Core</b>	Polyester/Polyamide
<b>Elongation at 10%</b>	2.8%
<b>Weight</b>	7.7 lb. per 100'   3.6 kg per 30 m
<b>Spliceable</b>	Yes, Hand



### FEATURES

- Direction up is a high-performance climbing rope for arborists
- Lightweight, yet large hand rope
- Rugged, long lasting line

SKU	FT	PRODUCT
832190372192	120'	Direction Up - 1/2"   13 mm

**Edelrid Direction Up** is a full 1/2" (13 mm). Direction up takes the 24-strand construction typically used for (11 mm) and uses it in a full bodied line. This makes for lightweight high strength climbing line with a 1/2" feeling grip.

## Sterling Scion Blue 11.5 mm

### SPECS

<b>Diameter</b>	7/16"   11.5 mm
<b>ABS</b>	6,740 lbs   3,057 kg
<b>Construction</b>	24-Strand Double-Braid
<b>Cover/Core</b>	Polyester/Nylon
<b>Elongation at 10%</b>	3.8%
<b>Weight</b>	6.2 lbs per 100'   2.8 kg per 30 m
<b>Spliceable</b>	Yes, Hand



### FEATURES

- Durable sheath is designed to handle mechanical devices and run efficiently through hardware
- Hand spliceable
- Certified: EN 1891: Type A, ANSI Z13

SKU	FT	PRODUCT
AC115060037	120'	Scion Blue - 7/16"   11.5 mm
AC115060037SET	120'	Scion Blue w/ eye - 7/16"   11.5 mm
AC115060046	150'	Scion Blue - 7/16"   11.5 mm
AC115060046SET	150'	Scion Blue w/ eye - 7/16"   11.5 mm
AC115060061	200'	Scion Blue - 7/16"   11.5 mm
AC115060061SET	200'	Scion Blue w/ eye - 7/16"   11.5 mm

**Scion's** ability to absorb dynamic forces makes this rope ideal for DdRT, and SRS. The 11.5 mm **Scion** is a double-braid featuring a burly polyester 24-strand sheath, yet engineered to have decreased elongation, soft handling and easy knotability.



## Sterling Scion Blue 12.5 mm

### SPECS

Diameter	1/2"   12.5 mm
ABS	7,193 lbs   3,269 kg
Construction	24-Strand Double-Braid
Cover/Core	Polyester/Nylon
Elongation at 10%	3.3%
Weight	7.2 lbs per 100'   3.3 kg per 30 m
Spliceable	Yes, Hand



Scion's ability to absorb dynamic forces makes this rope ideal for DdRT, and SRS. The 12.5 mm Scion is a double-braid featuring a burly polyester 24-strand sheath, yet engineered to have decreased elongation, soft handling and easy knotability.



### FEATURES

- Durable sheath is designed to handle mechanical devices and run efficiently through hardware
- Hand spliceable
- Excellent dual purpose rope (DRS & SRS)
- Great paired with 1/2" Rope Wrench
- Certified: EN 1891: Type A, ANSI Z13

SKU	FT	PRODUCT
AC125060046	150'	Scion Blue - 1/2"   12.5 mm
AC125060046SET	150'	Scion Blue w/ eye - 1/2"   12.5 mm
AC125060061	200'	Scion Blue - 1/2"   12.5 mm
AC125060061SET	200'	Scion Blue w/ eye - 1/2"   12.5 mm

## Teufelberger drenaLINE

### SPECS

Diameter	7/16"   11.8 mm
ABS	7,870 lbs   3,577 kg
Construction	Polyester/Nylon, Parallel
Cover/Core	32-Strand
Elongation at 10%	2.3%
Weight	6.5 lbs per 100'   3 kg per 30 m
Spliceable	Yes, spLIFE, or Sewn



drenaLINE... one rope, equally efficient! drenaLINE gives ultimate freedom to the climber to choose the right technique for the task.



### FEATURES

- Extremely light construction and 32-strand cover for super smooth precision during ascents and descents.
- Great kernmantle line for dual purpose style climbing (single or double rope)
- Works great with hardware
- Standard: EN 1891A, ANSI Z133-2012

SKU	FT	PRODUCT
012345	BULK	drenaLINE - 7/16"   11.8 mm
7350140	150'	drenaLINE - 7/16"   11.8 mm
7350141	200'	drenaLINE - 7/16"   11.8 mm

## Teufelberger drenaLINE Pink

### SPECS

Diameter	7/16"   11.8 mm
ABS	7,870 lbs   3,577 kg
Construction	Polyester/Nylon, Parallel
Cover/Core	32-Strand
Elongation at 10%	2.3%
Weight	6.5 lbs per 100'   3 kg per 30 m
Spliceable	Yes, spLIFE, or Sewn



drenaLINE Pink... one rope, equally efficient! drenaLINE gives ultimate freedom to the climber to choose the right technique for the task.



### FEATURES

- Extremely light construction and 32-strand cover for super smooth precision during ascents and descents.
- Great kernmantle line for dual purpose style climbing (single or double rope)
- Works great with hardware
- Standard: EN 1891A, ANSI Z133-2012

SKU	FT	PRODUCT
012343	BULK	drenaLINE Pink - 7/16"   11.8 mm

## Yale Blue Moon

### SPECS

Diameter	7/16"   11.7 mm
ABS	6,500 lbs   2,948 kg
Construction	24-Strand Double-Braid
Cover/Core	Polyester/Polyester
Elongation at 10%	1.4%
Weight	6.5 lbs per 100'   3 kg per 30 m
Spliceable	Yes, Hand
MPN	7352129R



A true 11.7 mm competition grade climbing line that blends benefits of being lightweight with a larger hand feel. Great service life without work hardening with firm braided filament core.



### FEATURES

- Mechanical device friendly due to its smooth cover
- Minimal bounce due to low elongation
- Minimal cover milking thanks to Yale's "Tite-Braid" cover
- Dual purpose climbing line - MRS & SRS

SKU	FT	PRODUCT
006223	BULK	Blue Moon - 7/16"   11.7 mm
007613	120'	Blue Moon - 7/16"   11.7 mm
93529Z21150XB	150'	Blue Moon - 7/16"   11.7 mm
93529V21000120	120'	Blue Moon w/Tight Eye Splice
93529V21150XB	150'	Blue Moon w/Tight Eye Splice
93529V21200XB	200'	Blue Moon w/Tight Eye Splice

# climbing lines

ROPE / CLIMBING LINES / 24-32-STRAND

## Yale Imori

### SPECS

<b>Diameter</b>	1/2"   12 mm
<b>ABS</b>	6,200 lbs   2,812 kg
<b>Construction</b>	24-Strand Double-Braid
<b>Cover/Core</b>	Polyester
<b>Elongation at 10%</b>	2.4%
<b>Weight</b>	7 lbs per 100'   3.2 kg per 30 m
<b>Spliceable</b>	Yes, Hand



### FEATURES

- Larger line increases ergonomic benefits
- Fiber is blended with a 100% solution dyed filament polyester into the construction
- Blend allows the fibers to be exposed on both the outer and inside sheaths providing more friction to the inner core
- Minimizes excessive elongation
- Excellent grip

SKU	FT	PRODUCT
008882	BULK	Imori - Green - 1/2"   12 mm
93529Z3345MXB	150'	Imori - Green - 1/2"   12 mm
007568	BULK	Imori - Orange - 1/2"   12 mm
93529Z4445MXB	150'	Imori - Orange - 1/2"   12 mm
012900	150'	Imori Green w/ Tight Eye Splice
012901	200'	Imori Orange w/ Tight Eye Splice

**Yale's Imori** is a lightweight rope that feels closer to a 1/2" line. **Imori's** unique textured strands give it a great hand that improves grip and makes this a rope like no other. Yale incorporated a type of taslanized (textured) fiber into the rope structure which provides bulk for grip. [Certified CE0120 EN1891 Type-A]

## Yale Blaze

### SPECS

<b>Diameter</b>	7/16"   11.4 mm
<b>ABS</b>	5,600 lbs   2,540 kg
<b>Construction</b>	24-Strand Double-Braid
<b>Cover/Core</b>	Polyester/Polyester
<b>Elongation at 10%</b>	1.4%
<b>Weight</b>	6 lbs per 100'   2.72 kg per 30 m
<b>Spliceable</b>	Yes, Hand



### FEATURES

- Lightweight
- High-visibility
- Hardware friendly
- Maintains flexibility

SKU	FT	PRODUCT
004733	BULK	Blaze - 7/16"   11.4 mm
93528V80000150	150'	Blaze w/ Tight Eye Splice

**Yale Blaze** - 24-Strand Super-lightweight, double-braid climbing ropes from one of the top manufacturers of arborist rope. **Blaze** is a 24-Strand, 11 mm (7/16") spliceable Double-Braid that is brightly colored and quick to see in the tree

## Pelican Arborist-24™ Yellow Jacket

### SPECS

<b>Diameter</b>	7/16"   11.1 mm
<b>ABS</b>	7,000 lbs   3,181 kg
<b>Construction</b>	24-Strand Double-Braid
<b>Cover/Core</b>	Polyester/Nylon
<b>Elongation at 10%</b>	5%
<b>Weight</b>	5.6 lbs per 100'   3 kg per 30 m
<b>Spliceable</b>	Yes, Hand



### FEATURES

- Chemical Resistant
- Double-Braid
- Smooth to Touch
- Lightweight
- Great for SRS Climbing

SKU	FT	PRODUCT
PYJ716150	150'	Arborist-24 Yellow Jacket - 7/16"   11.1 mm
PYJ716200	200'	Arborist-24 Yellow Jacket - 7/16"   11.1 mm
PYJ716600	600'	Arborist-24 Yellow Jacket - 7/16"   11.1 mm

**Pelican Arborist-24 Yellow Jacket** is a 24-Strand climbing line with a unique yellow and black color scheme.

**Yale Cordage** is one of my favorite suppliers of rope. I have both the **Yale Imori** and **Yale Scandere**. The **Imori** is my go-to rope for my double rope climbing system with a perfect elongation to reduce some of the stiffness and also having a great rope construction for handling throughout the tree. The construction is a 24 strand but with a weave that is super comfortable to work with all day. I also have the **Yale Scandere** which is my favorite access line for SRS. It is a 48 strand with little to no elongation perfect for that single line ascent and it also has a very tight weave for smooth descents. It's like descending on butter with little to no bunching of the weave of the rope. They both have a great range of colors that are highly visible and are just all-around great working ropes!"

—Corey Gagne, Professional Arborist, MA



## Samson ArborMaster® Hawkeye

### SPECS

Diameter	1/2"   12 mm
ABS	6,500 lbs   2,900 kg
Construction	16-Strand
Cover/Core	Polyester/Nylon
Elongation at 10%	3%
Weight	6.5 lbs per 100'   3.5 kg per 30 m
Spliceable	Yes, Hand



ArborMaster offers the maximum firmness for all climbing techniques. Its 1/2" diameter provides an easy grip, and has low stretch and excellent knot-holding capability. ArborMaster is spliceable at both ends without milking.



### FEATURES

- Durable, easy grip
- Hardware compatible
- Great high visibility, steady fast colors

SKU	FT	PRODUCT
010002	BULK	ArborMaster Hawkeye - 1/2"   12 mm
HE12120	120'	ArborMaster Hawkeye - 1/2"   12 mm
HE12150	150'	ArborMaster Hawkeye - 1/2"   12 mm
HE12200	200'	ArborMaster Hawkeye - 1/2"   12 mm
HE12600	600'	ArborMaster Hawkeye - 1/2"   12 mm
HE12120S	120'	ArborMaster Hawkeye w/ Tight Eye Splice
HE12150S	150'	ArborMaster Hawkeye w/ Tight Eye Splice

## Samson ArborMaster® Blue Streak

### SPECS

Diameter	1/2"   12 mm
ABS	6,500 lbs   2,900 kg
Construction	16-Strand
Cover/Core	Polyester/Nylon
Elongation at 10%	3%
Weight	6.5 lbs per 100'   3.5 kg per 30 m
Spliceable	Yes, Hand



ArborMaster offers the maximum firmness for all climbing techniques. Its 1/2" diameter provides an easy grip, and has low stretch and excellent knot-holding capability. ArborMaster is spliceable at both ends without milking.



### FEATURES

- Durable, easy grip
- Hardware compatible
- Familiar, tried and true
- Solid, long lasting line

SKU	FT	PRODUCT
000567	BULK	ArborMaster Blue Streak - 1/2"   12 mm
BS12120	120'	ArborMaster Blue Streak - 1/2"   12 mm
BS12150	150'	ArborMaster Blue Streak - 1/2"   12 mm
BS12200	200'	ArborMaster Blue Streak - 1/2"   12 mm
BS12600	600'	ArborMaster Blue Streak - 1/2"   12 mm
BS12120S	120'	ArborMaster Blue Streak w/ Tight Eye Splice
BS12150S	150'	ArborMaster Blue Streak w/ Tight Eye Splice

## Samson ArborMaster® Red, Black, and White

### SPECS

Diameter	1/2"   12 mm
ABS	6,500 lbs   2,900 kg
Construction	16-Strand
Cover/Core	Polyester/Nylon
Elongation at 10%	3%
Weight	6.5 lbs per 100'   3.5 kg per 30 m
Spliceable	Yes, Hand



ArborMaster offers the maximum firmness for all climbing techniques. Its 1/2" diameter provides an easy grip, and has low stretch and excellent knot-holding capability. ArborMaster is spliceable at both ends without milking.



### FEATURES

- Durable; "wears like iron, a real workhorse"
- Easy grip
- Hardware compatible

SKU	FT	PRODUCT
001921	BULK	ArborMaster Red, Black, White - 1/2"   12 mm
MC12120	120'	ArborMaster Red, Black, White - 1/2"   12 mm
MC12150	150'	ArborMaster Red, Black, White - 1/2"   12 mm
MC12600	600'	ArborMaster Red, Black, White - 1/2"   12 mm
MC12120S	120'	ArborMaster RBW w/ Tight Eye Splice
MC12150S	150'	ArborMaster RBW w/ Tight Eye Splice

## Teufelberger Safety Blue - Hi-Vee

### SPECS

Diameter	1/2"   12.7 mm
ABS	5,800 lbs   2,636 kg
Construction	16-Strand
Cover/Core	Polyester/Polyamide
Elongation at 10%	3%
Weight	7 lbs per 100'   3.2 kg per 30 m
Spliceable	Yes, Hand



Teufelberger Safety Blue is named for the blue core fibers. If your line is cut or significantly worn the color acts as a warning indicator to the user. Safety Blue has been an industry favorite since it was introduced. Great climbing line with high strength, flexibility, and safety features.



### FEATURES

- Safety blue is treated with a special coating for durability and grip
- Plied strand yarns for improved abrasion resistance
- Affordable and strong

SKU	FT	PRODUCT
000517	BULK	Safety Blue - Hi-Vee - 1/2"   12.7 mm
NEHV12120	120'	Safety Blue - Hi-Vee - 1/2"   12.7 mm
NEHV12150	150'	Safety Blue - Hi-Vee - 1/2"   12.7 mm
NEHV12200	200'	Safety Blue - Hi-Vee - 1/2"   12.7 mm
NEHV12600	600'	Safety Blue - Hi-Vee - 1/2"   12.7 mm

# climbing lines

ROPE / CLIMBING LINES / 16-STRAND

## Teufelberger Safety Blue – Ultra-Vee

### SPECS

Diameter	1/2"   12.7 mm
ABS	5,800 lbs   2,636 kg
Construction	16-Strand
Cover/Core	Polyester/Polyamide
Elongation at 10%	3%
Weight	7 lbs per 100'   3.2 kg per 30 m
Spliceable	Yes, Hand



Teufelberger Safety Blue is named for the blue core fibers. If your line is cut or significantly worn the color acts as a warning indicator to the user. Safety Blue has been an industry favorite since it was introduced. Great climbing line with high strength, flexibility, and safety features.



### FEATURES

- Safety blue is treated with a special coating for durability and grip
- Plied strand yarns for improved abrasion resistance
- Affordable and strong

SKU	FT	PRODUCT
004437	BULK	Safety Blue – Ultra-Vee – 1/2"   12.7 mm
NEUV12120	120'	Safety Blue – Ultra-Vee – 1/2"   12.7 mm
NEUV12150	150'	Safety Blue – Ultra-Vee – 1/2"   12.7 mm
NEUV12200	200'	Safety Blue – Ultra-Vee – 1/2"   12.7 mm
NEUV12600	600'	Safety Blue – Ultra-Vee – 1/2"   12.7 mm
012893	120'	Safety Blue – Ultra-Vee w/Tight Eye Splice
012894	150'	Safety Blue – Ultra-Vee w/Tight Eye Splice

## Teufelberger Safety Blue – White

### SPECS

Diameter	1/2"   12.7 mm
ABS	5,800 lbs   2,636 kg
Construction	16-Strand
Cover/Core	Polyester/Polyamide
Elongation at 10%	3%
Weight	7 lbs per 100'   3.2 kg per 30 m
Spliceable	Yes, Hand



Teufelberger Safety Blue is named for the blue core fibers. If your line is cut or significantly worn the color acts as a warning indicator to the user. Safety Blue has been an industry favorite since it was introduced. Great climbing line with high strength, flexibility, and safety features.



### FEATURES

- Safety blue is treated with a special coating for durability and grip
- Plied strand yarns for improved abrasion resistance
- Affordable and strong

SKU	FT	PRODUCT
000513	BULK	Safety Blue – White – 1/2"   12.7 mm
NESB12120	120'	Safety Blue – White – 1/2"   12.7 mm
NESB12150	150'	Safety Blue – White – 1/2"   12.7 mm
NESB12600	600'	Safety Blue – White – 1/2"   12.7 mm

## Yale XTC Fire

### SPECS

Diameter	1/2"   13 mm
ABS	6,200 lbs   2,812 kg
Construction	16-Strand
Cover/Core	Polyester/Polyester
Elongation at 10%	1.4%
Weight	7.5 lb per 100'   3.4 kg per 30 m
Spliceable	Yes, Hand



Yale Cordage XTC 16 Fire Arborist Rope is specifically designed for the demanding needs of arborists. Can be used for either climbing or rigging. Made in USA.



### FEATURES

- Brightly colored, highly visible
- One of Yale's most popular lines
- Tightly-braided cover with a firm feel
- Parallel core is twisted and torque-balanced
- Stays round, is snag-resistant, wears extremely well
- Certs: E0120 EN1891 Type-A

SKU	FT	PRODUCT
006668	BULK	XTC Fire – 1/2"   13 mm
93532Z79150XB	150'	XTC Fire – 1/2"   13 mm

## Yale XTC Plus

### SPECS

Diameter	1/2"   13 mm
ABS	6,200 lbs   2,812 kg
Construction	16-Strand
Cover/Core	Polyester/Polyester
Elongation at 10%	1.4%
Weight	7.5 lb per 100'   3.4 kg per 30 m
Spliceable	Yes, Hand



XTC Plus is a premium climbing line – the vibrant red and white color is distinctive and easy to spot. Made for quick color recognition: Red for rig and Green for go. This line is specifically designed for the demanding needs of arborists, embodying the same characteristics of XTC ropes Yale has made for over two decades. Made in USA.



### FEATURES

- Made from extrusion-dyed polyester = steadfast color
- Tightly woven 16-strand construction
- High twist core of torque-balanced polyester keeps the line firm and round
- High performance

SKU	FT	PRODUCT
002121	BULK	XTC Plus – 1/2"   13 mm
93532Z86120XB	120'	XTC Plus – 1/2"   13 mm
93532Z86150XB	150'	XTC Plus – 1/2"   13 mm
93532Z86200XB	200'	XTC Plus – 1/2"   13 mm



## Yale XTC 16 Spearmint

### SPECS

Diameter	1/2"   13 mm
ABS	6,200 lbs   2,812 kg
Construction	16-Strand
Cover/Core	Polyester/Polyester
Elongation at 10%	1.4%
Weight	7.5 lb per 100'   3.4 kg per 30 m
Spliceable	Yes, Hand



Yale XTC 16 Spearmint climbing line is one of the first climbing ropes specifically manufactured for double rope technique in tree climbing. The vibrant green and white color is distinctive and easy to spot. Made for quick color recognition: green for go and red for rig.



### FEATURES

- Practically non-rotating
- Extremely tight woven sheath
- Easy to knot and to handle
- Long lasting because of its abrasion-resistant construction
- Great with cordage hitches and mechanical devices
- A timeless classic that to this day has no reason to shy away from any comparison with other climbing ropes.

SKU	FT	PRODUCT
000800	BULK	XTC 16 Spearmint - 1/2"   13 mm
93532Z87120XB	120'	XTC 16 Spearmint - 1/2"   13 mm
93532Z87150XB	150'	XTC 16 Spearmint - 1/2"   13 mm
93532Z87200XB	200'	XTC 16 Spearmint - 1/2"   13 mm

## Yale XTC 16 White

### SPECS

Diameter	1/2"   13 mm
ABS	6,200 lbs   2,812 kg
Construction	16-Strand
Cover/Core	Polyester/Polyester
Elongation at 10%	1.4%
Weight	7.5 lb per 100'   3.4 kg per 30 m
Spliceable	Yes, Hand



Yale XTC 16 White is an economical with a tight braid consisting of 16-Strands of polyester. A high twist core of torque-balanced polyester keeps the construction firm and round, providing an extra measure of safety.



### FEATURES

- Excellent choice for both climbing line and bull rope
- Non-snagging
- Abrasion-resistant construction
- Excellent energy absorption characteristics

SKU	FT	PRODUCT
008009	BULK	XTC White - 1/2"   13 mm
93532ZZ150XB	150'	XTC White - 1/2"   13 mm

## Edelrid X-P\*e

### SPECS

Diameter	1/2"   12.3 mm
ABS	5,395 lbs   2,447 kg
Construction	16-Strand
Cover/Core	Polyester/Polyester
Elongation at 10%	2.2%
Weight	7.7 lbs per 100'   3.5 kg per 30 m
Spliceable	Yes



X-P\*e is a tried-and-true climbing line developed in close cooperation with users and professionals. The special thickly-twined sheath construction provides maximum abrasion resistance and the Thermo Shield treatment provides perfect handling.



### FEATURES

- Bright visible colors
- Great abrasion resistant
- Thermo Shield treatment
- Bluesign certified
- Certs: CE Marking: CE 0123
- Origin: German

SKU	FT	PRODUCT
889510462322	150'	X-P*e Aruba - 1/2"   12 mm
889510612322	200'	X-P*e Aruba - 1/2"   12 mm
889510469342	150'	X-P*e Seychelles - 1/2"   12 mm
889510619342	200'	X-P*e Seychelles - 1/2"   12 mm

## Pelican Green, White, and Black

### SPECS

Diameter	1/2"   13 mm
ABS	7,150 lbs   3,250 kg
Construction	16-Strand
Cover/Core	Polyester/Nylon
Elongation at 10%	8.4 lbs per 100'   3.8 kg per 30 m
Weight	2.8%
Spliceable	Yes, Hand



**EXCLUSIVE PRODUCT** Green, White, and Black 16-Strand - Unique colored 16-strand climbing line.



### FEATURES

- High visibility and flexibility
- Full 1/2" diameter
- High strength chemical resistant cover
- Non-rotational nylon parallel core

ROPE SKU	ROPE WITH BAG SKU	FT	PRODUCT
GBW12120	GBW12120BC	120'	GWB - 1/2"   13 mm
GBW12150	GBW12150BC	150'	GWB - 1/2"   13 mm
GBW12200	GBW12200BC	200'	GWB - 1/2"   13 mm
GBW12600	GBW12600BC	600'	GWB - 1/2"   13 mm



# climbing lines

ROPE / CLIMBING LINES / 16-STRAND

## Pelican Arborist-16™ Hi-Vis

### SPECS

Diameter	1/2"   13 mm
ABS	7,150 lbs   3,250 kg
Construction	16-Strand
Cover/Core	Polyester/Nylon
Elongation at 10%	8.4 lbs per 100'   3.8 kg per 30 m
Weight	2.8%
Spliceable	Yes, Hand

**PELICAN ROPE**  
The Most Trusted Name In Rope®

### FEATURES

- High visibility and flexibility
- Firm Construction
- Low Stretch
- Full 1/2" diameter
- High strength chemical resistant cover
- Non-rotational nylon parallel core

SKU	FT	PRODUCT
POW12120	120'	Arborist-16 Hi-Vis - 1/2"   13 mm
POW12150	150'	Arborist-16 Hi-Vis - 1/2"   13 mm
POW12200	200'	Arborist-16 Hi-Vis - 1/2"   13 mm
POW12600	600'	Arborist-16 Hi-Vis - 1/2"   13 mm

Pelican Arborist-16 Hi-Vis is a tried and true climbing line.



Photo by Walter Goodridge



## Samson Arbor-Plex

### SPECS

Diameter	1/2"   12 mm
ABS	6,000 lbs   2,700 kg
Construction	12-Strand
Cover/Core	Polyester Blend/Polypropylene
Elongation at 10%	3%
Weight	6.8 lbs per 100'   10.1 kg per 30 m
Spliceable	No



The first synthetic rope designed specifically for the arborist industry. **Samson Arbor-Plex** remains flexible and retains shape with use.



### FEATURES

- Durable
- Firm construction
- High strength
- Low stretch

SKU	FT	PRODUCT
000551	BULK	Arbor-Plex - 1/2"   12 mm
AP12120	120'	Arbor-Plex - 1/2"   12 mm
AP12150	150'	Arbor-Plex - 1/2"   12 mm
AP12600	600'	Arbor-Plex - 1/2"   12 mm

## Samson True-Blue

### SPECS

Diameter	1/2"   12 mm
ABS	7,300 lbs   3,300 kg
Construction	Single 12-Strand Braid
Cover/Core	Polyester/Polyester
Elongation at 10%	2.6%
Weight	8.8 lbs per 100'   3.9 kg per 30 m
Spliceable	No



Soft hand and good flexibility and knot holding abilities. Minimal to no milking and stays firm and round in use. **True-Blue** can also be used for light duty rigging applications. A unique combination of solution dyed blue polyester fiber wrapped over white polyester.



### FEATURES

- An all-polyester climbing rope with excellent abrasion resistance, and a long service life.
- Low stretch, High strength
- Permanent color that won't fade or run, with high visibility in trees.

SKU	FT	PRODUCT
000563	BULK	True-Blue - 1/2"   12 mm
TB12120	120'	True-Blue - 1/2"   12 mm
TB12150	150'	True-Blue - 1/2"   12 mm
TB12200	200'	True-Blue - 1/2"   12 mm
TB12600	600'	True-Blue - 1/2"   12 mm

## Samson True-White

### SPECS

Diameter	1/2"   12 mm
ABS	7,300 lbs   3,300 kg
Construction	Single 12-Strand Braid
Cover/Core	Polyester/Polyester
Elongation at 10%	2.6%
Weight	8.8 lbs per 100'   3.9 kg per 30 m
Spliceable	No



Soft hand and good flexibility and knot holding abilities. Minimal to no milking and stays firm and round in use. **True-White** can also be used for light duty rigging applications. A unique combination of solution dyed blue polyester fiber wrapped over white polyester.



### FEATURES

- An all-polyester climbing rope with excellent abrasion resistance, and a long service life.
- Low stretch, High strength
- Permanent color that won't fade or run, with high visibility in trees.

SKU	FT	PRODUCT
TW12120	120'	True-White - 1/2"   12 mm
TW12150	150'	True-White - 1/2"   12 mm
TW12200	200'	True-White - 1/2"   12 mm
TW12600	600'	True-White - 1/2"   12 mm

## Yale XTC 12 White

### SPECS

Diameter	1/2"   12 mm
ABS	6,000 lbs   2,700 kg
Construction	12-Strand
Cover/Core	Polyester/"Para-ep" Olefin Construction
Elongation at 10%	2%
Weight	6.7 lbs per 100'   10.1 kg per 30 m
Spliceable	No



**XTC 12 White** is an economical alternative. This rope was designed specifically for the demanding needs of the professional arborist. **XTC** is a tight braid consisting of a high twist core of torque balanced polyester which keeps the construction firm and round, providing an extra measure of safety.



### FEATURES

- Excellent choice for both climbing line and bull rope
- Non-snagging
- Abrasion-resistant construction
- Excellent energy absorption characteristics

SKU	FT	PRODUCT
XTT12120	120'	XTC 12 - White
XTT12150	150'	XTC 12 - White
XTT12200	200'	XTC 12 - White
XTT12600	600'	XTC 12 - White





Research.  
Test.  
Re-evaluate.  
Innovate.  
Repeat.



Blue Moon



Polydyne



Scandere



XTC Fire

For 70 years, we've built our business on innovation and quality. These hallmarks are woven into the products we deliver and are embraced by the people who rely on us. Safety and performance are paramount, as is our commitment to only use the most advanced materials and construction methods. This is what sets us apart. This is what keeps you safe up there.

Learn more about the world's best lines at [yalecordage.com](http://yalecordage.com)





## Yale Safari Kernmaster

### SPECS

Diameter	7/16"   11.7 mm
ABS	7,100 lbs   3,220 kg
Construction	48 Strand Kernmantle
Cover/Core	Polyester/Nylon
Elongation at 10%	3%
Weight	5.5 lbs per 100'   2.5 kg per 30 m
Spliceable	No, Sewn



Yale Safari Dual Purpose Climbing Line – Meet Yale's Kernmaster, a 48-strand Kernmantle rope with an outer polyester jacket over an energy-absorbing nylon core. Makes an excellent Single Rope Technique or System (SRT/SRS) line.



### FEATURES

- Very low stretch and works smoothly in all of Single Rope hardware.
- Good energy absorption
- Core fibers of Kernmaster are braided, unlike most other Kernmasters, which makes it perform more like a 24-strand, allowing for both access and DdRT (MRS) climbing using quick hitches.
- Supple hand provides a less "cable" feel of hand when working at height
- Certifications: CE/EN1891 rated
- Made in USA

SKU	FT	PRODUCT
967282132200XB	200'	Safari Kernmaster – 7/16"   11.7 mm

## Yale Scandere

### SPECS

Diameter	15/32"   11.7 mm
ABS	7,100 lbs   3,220 kg
Construction	48 Strand Kernmantle
Cover/Core	Polyester/Nylon
Elongation at 10%	3%
Weight	6.5 lbs per 100'   2.91 kg per 30 m
Spliceable	No, Sewn



Yale's Scandere is their newly released 48-strand kernmantle built to work with the newest climbing hardware. With effort made to be slightly larger than most 'single lines' the diameter is slightly less than a 1/2" and low stretch.



### FEATURES

- Runs well in all modern hardware
- Excellent competition and SRT work line
- Soft hand
- Bright colors: Neon yellow, red, or purple

SKU	FT	PRODUCT
76721629R	BULK	Scandere Red – 15/32"   11.7 mm
96729221645MXB	150'	Scandere Red – 15/32"   11.7 mm
7979629R	BULK	Scandere Yellow – 15/32"   11.7 mm
9672929645MXB	150'	Scandere Yellow – 15/32"   11.7 mm
7678629R	BULK	Scandere Purple – 15/32"   11.7 mm
9672928645MXB	150'	Scandere Purple – 15/32"   11.7 mm

## Sterling HTP Static

### SPECS

Diameter	7/16"   11 mm
ABS	6,856 lbs   3,116 kg
Construction	44 Strand Kernmantle
Cover/Core	Polyester/Polyester
Elongation at 10%	2.5%
Weight	6.5 lbs per 100'   2.99 kg per 30 m
Spliceable	No, Sewn



Maximum strength with low stretch. A multi-use rescue and rappel rope perfect for rope rescue, rope access, and efficient ascending/descending.



### FEATURES

- Low-stretch properties
- High-moisture resistance allows the 7/16" to operate consistently in wet and dry conditions.
- Also available in our Bi-color pattern, which provides an added safety measure for arbor climbing SRS systems.

SKU	FT	PRODUCT
P110210061	200'	HTP Static Bi-color – 7/16"   11 mm
P110970061SET	200'	HTP Static Bi-color w/Tight eye – 7/16"   11 mm

## Sterling WorkPro

### SPECS

Diameter	1/2"   12.5 mm
ABS	10,565 lbs   4,792 kg
Construction	32-Strand Double-Braid
Cover/Core	Polyester/Nylon
Elongation at 10%	3.2%
Weight	7.4 lbs per 100'   3.5 kg per 30 m
Spliceable	No, Sewn



Sterling WorkPro has a balanced elongation in the core and sheath so they share the load evenly. This design makes the WorkPro Series stronger than other ropes of similar construction while retaining a small but important amount of elongation.

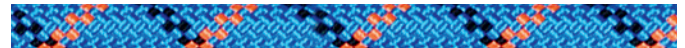

### FEATURES

- Design allows strength and low elongation
- Compatible with popular hardware for climbing and descent systems, this rope is also easier to grip.
- Dual purpose climbing line for SRS and MRS
- Certs: NFPA 1983: General EN 1891: Type A ANSI Z133

SKU	FT	PRODUCT
011351	BULK	WorkPro Blue – 1/2"   12.5 mm
WP125BLUE SET-TIGHT	200'	WorkPro Blue with Eye – 1/2"   12.5 mm

# climbing lines

ROPE / CLIMBING LINES / STATIC KERNMANTLE

## Samson Mercury

### SPECS

<b>Diameter</b>	7/16"   11 mm
<b>ABS</b>	8,600 lbs   3,900 kg
<b>Construction</b>	32-Strand Kernmantle, parallel core
<b>Cover/Core</b>	Polyester/Nylon
<b>Elongation at 10%</b>	3.7%
<b>Weight</b>	6 lbs per 100'   2.6 kg per 30 m
<b>Spliceable</b>	No, Sewn



**Mercury** rose to add to a great **Samson** line up. Excellent for Single Rope Systems (SRS), rescue, and speedline applications. A kernmantle construction and a nylon parallel strand core has a 32-Strand polyester cover creates durability, superior strength, a soft hand and ease of knot tying.



### FEATURES

- Mercury SRS/SRT Kernmantle Static Climbing Line is designed to equal or exceed the 2001 NFPA standards
- Provides firm body and good shock mitigation
- Balanced non-rotational rope
- High tenacity solution dyed braided polyester cover over a heat-stabilized nylon core.
- High-strength static ascent line, excellent rappelling, and rescue line

SKU	FT	PRODUCT
485028600000	BULK	Mercury - 7/16"   11 mm
485028601560	150'	Mercury - 7/16"   11 mm
485028602060	200'	Mercury - 7/16"   11 mm

## Teufelberger Platinum® Protect PES/PA

### SPECS

<b>Diameter</b>	7/16"   10.5 mm
<b>ABS</b>	6,290 lbs   2,859 kg
<b>Construction</b>	32-Strand Kernmantle
<b>Cover/Core</b>	Polyester/Polyamide
<b>Elongation at 10%</b>	2%
<b>Weight</b>	5.2 lbs per 100'   2.4 kg per 30 m
<b>Spliceable</b>	No, Sewn



**Teufelberger Platinum** is a static rope certified to EN 1891A, NFPA 1983:2012. Novel design and low elongation, is a must-have for every industrial climber.



### FEATURES

- Designed for rope access at extreme heights
- Permanent mechanical connection between the cores and the cover increases safety, but also prolongs the rope's life.
- Extremely low elongation
- Stays flexible in wet conditions
- Excellent UV stability
- Certified with: PETZLASAP (B7, B71AAA, B071AA00), only with ASAP Sorber 20+40 or Absorbica according to EN 353-2; PETZLASAP LOCK (B071BAA00) in use with ASAP'SORBER AXESS according to EN 353-2

SKU	FT	PRODUCT
C7360700-150FT	150'	Platinum Protect - 7/16"   10.5 mm

## Teufelberger xSTATIC

### SPECS

<b>Diameter</b>	15/32"   11.7 mm
<b>ABS</b>	7,190 lbs   3,268 kg
<b>Construction</b>	32-Strand Kernmantle
<b>Cover/Core</b>	Polyester/Nylon
<b>Elongation at 10%</b>	1.4%
<b>Weight</b>	7.1 lbs per 100'   3.2 kg per 30 m
<b>Spliceable</b>	No, Sewn



**xSTATIC** 11.7 mm is straight to the point; designed to be a perfectly static rope specifically for Single Rope System (SRS) climbing. Tight jacket for quick descents and smooth gear retrieval. This rope will keep you smiling with the rope construction and visual design.



### FEATURES

- Designed for Single Rope Systems (SRS)
- Perfectly static, ultra low-stretch
- Built for SRT
- Tight Jacket
- Great with mechanical ascenders
- Standard: EN 1891A, ANSI Z133-2012

SKU	FT	PRODUCT
011353	BULK	xSTATIC - 15/32"   11.7 mm
C3563-14-00150	150'	xSTATIC - 15/32"   11.7 mm
C3563-14-00200	200'	xSTATIC - 15/32"   11.7 mm

## Teufelberger KM-III Max

### SPECS

<b>Diameter</b>	7/16"   11 mm
<b>ABS</b>	7,900 lbs   3,583 kg
<b>Construction</b>	32-Strand, Kernmantle
<b>Cover/Core</b>	Kevlar
<b>Elongation at 10%</b>	1.8%
<b>Weight</b>	6.1 lbs per 100'   2.8 kg per 30 m
<b>Spliceable</b>	No, Sewn



A well-balanced and low-rotating kernmantle line with a unique twill design that ensures work positioning with smooth descents. The Twill Pattern Technology provides a cover that is super-smooth and reduces creeping while providing amazing abrasion resistance.

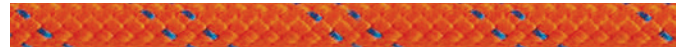

### FEATURES

- Special Twill Pattern Technology cover
- Super smooth cover
- Ultra-abrasion resistant
- Improved controllability during descent
- Certifications: Certified to EN 1891A and NFPA 1983:2012

SKU	FT	PRODUCT
C3345-14-00200	200'	KM-III Max - 7/16"   11 mm



## Edelrid Static Low Stretch

### SPECS

Diameter	7/16"   11 mm
ABS	7,868 lbs   3,569 kg
Construction	Static, 32-Strand Kernmantle
Cover/Core	Polyester/Polyamide
Elongation at 10%	1.8%
Weight	5.4 lbs per 100'   2.46 kg per 30 m
Spliceable	No, Sewn



Edelrid's static lines make good choices for access lines, foot-locking, SRS applications. The number one choice for precise work on and with ropes. The minimum elongation enables the effortless climbing of the rope making it an ideal companion when working at heights.



### FEATURES

- Tracer threads on the sheath to indicate rope diameter
- Thermo Shield treatment for perfect handling
- Multiple-wound polyester sheath results in elongation values of less than 2% for greater precision when working
- Conforms to safety certification for static ropes (EN 1891 Type A)
- High abrasion and cut resistant
- Made in Germany

SKU	FT	PRODUCT
012695	BULK	Static Low Stretch Green - 7/16"   11 mm
832200924992	300'	Static Low Stretch Green - 7/16"   11 mm
832201834992	600'	Static Low Stretch Green - 7/16"   11 mm

## Pelican Static Master 7/16"

### SPECS

Diameter	7/16"   11 mm
ABS	7,000 lbs   3,203 kg
Construction	32-Strand Kernmantle
Cover/Core	Polyester/Nylon
Elongation at 10%	4.3%
Weight	5.7 lbs per 100'   2.58 kg per 30 m
Spliceable	No, Sewn



Pelican Rope's Static Master features a tough, chemical resistant polyester cover over a non-rotational, parallel nylon core; making it ideal for SRS ascents, rappelling, and safety/rescue operations. Static Master allows little stretch while the nylon core provides energy absorption. Its firm braid is flexible enough to be tied and passed over pulleys and sheaves with ease. The core fibers provide and maintain the tensile strength while the sheath protects the core from abrasion.



### FEATURES

- Guaranteed Excellent Performance
- Low Stretch
- Excellent Grip Feature
- Great Repelling Rope
- Firm Yet Flexible
- Steam set to eliminate milking
- Maximum Energy Absorption

SKU	FT	PRODUCT
PSK716150	150'	Static Master - 7/16"   11 mm
PSK716200	200'	Static Master - 7/16"   11 mm
PSK716600	600'	Static Master - 7/16"   11 mm

## Pelican Static Master 1/2"

### SPECS

Diameter	1/2"   13 mm
ABS	9,807 lbs   4,457 kg
Construction	32-Strand Kernmantle
Cover/Core	Polyester/Nylon
Elongation at 10%	4.3%
Weight	7.5 lbs per 100'   3.4 kg per 30 m
Spliceable	No, Sewn



Pelican Rope's Static Master features a tough, chemical resistant polyester cover over a non-rotational, parallel nylon core; making it ideal for SRS ascents, rappelling, and safety/rescue operations. Static Master allows little stretch while the nylon core provides energy absorption. Its firm braid is flexible enough to be tied and passed over pulleys and sheaves with ease. The core fibers provide and maintain the tensile strength while the sheath protects the core from abrasion.



### FEATURES

- Guaranteed Excellent Performance
- Low Stretch
- Excellent Grip Feature
- Great Repelling Rope
- Firm Yet Flexible
- Steam set to eliminate milking
- Maximum Energy Absorption

SKU	FT	PRODUCT
PSK12150	150'	Static Master - 1/2"   13 mm
PSK12200	200'	Static Master - 1/2"   13 mm
PSK12600	600'	Static Master - 1/2"   13 mm

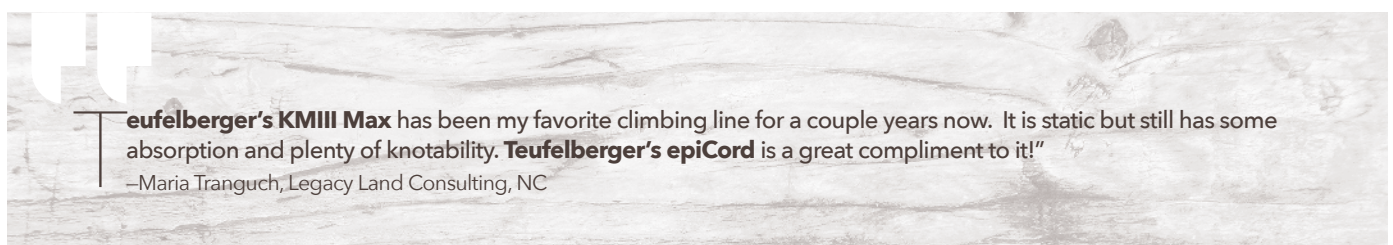

Teufelberger's KMIII Max has been my favorite climbing line for a couple years now. It is static but still has some absorption and plenty of knotability. Teufelberger's epiCord is a great compliment to it!"

—Maria Tranguch, Legacy Land Consulting, NC

# rigging lines

## Samson Stable Braid

**Stable Braid** is a low stretch Double-Braid, high strength-to-weight ratio, and torque-free construction. It is durable with excellent abrasion and UV resistance. **Stable Braid** offers durability, ease of handling and spliceability so you can take full advantage of its high strength.

### FEATURES

- Excellent abrasion resistance
- Firm, yet flexible
- Flex-fatigue, UV, and heat resistant
- High strength-to-weight ratio



### SPECS

Diameter	1/2"   12 mm
ABS	10,400 lbs   4,700 kg
Construction	20 Strand Double-Braid
Cover/Core	Polyester
Elongation at 10%	1.1%
Weight	8.2 lbs per 100'   3.6 kg per 30 m
Spliceable	Yes, Hand



SKU	FT	PRODUCT
SB12150	150'	Stable Braid Blue - 1/2"   12 mm
SB12200	200'	Stable Braid Blue - 1/2"   12 mm
SB12600	600'	Stable Braid Blue - 1/2"   12 mm

Diameter	9/16"   14 mm
ABS	13,300 lbs   6,000 kg
Construction	Double-Braid
Cover/Core	Polyester
Elongation at 10%	1.1%
Weight	11 lbs per 100'   4.9 kg per 30 m
Spliceable	Yes, Hand



SKU	FT	PRODUCT
SB916150	150'	Stable Braid Yellow - 9/16"   14 mm
SB916200	200'	Stable Braid Yellow - 9/16"   14 mm
SB916600	600'	Stable Braid Yellow - 9/16"   14 mm

Diameter	5/8"   16 mm
ABS	16,300 lbs   7,400 kg
Construction	Double-Braid
Cover/Core	Polyester
Elongation at 10%	1.1%
Weight	14 lbs per 100'   6.2 kg per 30 m
Spliceable	Yes, Hand



SKU	FT	PRODUCT
SB58150	150'	Stable Braid Red - 5/8"   16 mm
SB58200	200'	Stable Braid Red - 5/8"   16 mm
SB58600	600'	Stable Braid Red - 5/8"   16 mm

Diameter	3/4"   18 mm
ABS	20,400 lbs   9,300 kg
Construction	Double-Braid
Cover/Core	Polyester
Elongation at 10%	1.1%
Weight	18 lbs per 100'   6.2 kg per 30 m
Spliceable	Yes, Hand



SKU	FT	PRODUCT
SB34150	150'	Stable Braid Orange - 3/4"   18 mm
SB34200	200'	Stable Braid Orange - 3/4"   18 mm
SB34600	600'	Stable Braid Orange - 3/4"   18 mm



## Yale Polydyne

**Yale Polydyne** rigging lines are high-strength, abrasion-resistant double-braid polyester ropes that will deliver professional performance. **Polydyne** utilizes a polyester sleeve over a nylon core. Despite the dissimilar stretch characteristics of these fibers, **Yale** engineers have produced constructions where both fibers contribute. The resulting rope has high breaking strength and more stretch in its working load range. **Polydyne** is up to taking more dynamic abuse without being degraded prematurely. Take special note of the working energy-absorption rating, which is the amount of energy a rope absorbs before reaching its working load. The ultimate energy absorption of this rope is also correspondingly high.

### SPECS

<b>Diameter</b>	1/2"   13 mm
<b>ABS</b>	11,000 lbs   4,990 kg
<b>Construction</b>	Double-Braid
<b>Cover/Core</b>	Polyester/Nylon
<b>Elongation at 10%</b>	3%
<b>Weight</b>	7.6 lbs per 100'   11.3 kg per 30 m
<b>Spliceable</b>	Yes, Hand

<b>Diameter</b>	9/16"   14 mm
<b>ABS</b>	15,000 lbs   6,810 kg
<b>Construction</b>	Double-Braid
<b>Cover/Core</b>	Polyester/Nylon
<b>Elongation at 10%</b>	3%
<b>Weight</b>	9.7 lbs per 100'   14.4 kg per 30 m
<b>Spliceable</b>	Yes, Hand

<b>Diameter</b>	5/8"   16 mm
<b>ABS</b>	18,900 lbs   8,580 kg
<b>Construction</b>	Double-Braid
<b>Cover/Core</b>	Polyester/Nylon
<b>Elongation at 10%</b>	3%
<b>Weight</b>	13.6 lbs per 100'   20.3 kg per 30 m
<b>Spliceable</b>	Yes, Hand

## Yale Portland Braid

**Portland Braid** double-braided polyester offers high value at a very competitive price. **Portland Braid** offers consistent performance at an economical price. **Portland Braid** is a firm, yet easily spliceable rope that allows for good handling and conformance to sheaves. Also available with optional Maxijacket urethane coating to further enhance the rope's wear resistance.

### SPECS

<b>Diameter</b>	5/8"   16 mm
<b>ABS</b>	14,900 lbs   6,760 kg
<b>Construction</b>	20 Strand Double-Braid
<b>Cover/Core</b>	Polyester
<b>Elongation at 10%</b>	1.1%
<b>Weight</b>	13 lbs per 100'   5.8 kg per 30 m
<b>Spliceable</b>	Yes, Hand

<b>Diameter</b>	3/4"   19 mm
<b>ABS</b>	16,200 lbs   8,170 kg
<b>Construction</b>	20 Strand Double-Braid
<b>Cover/Core</b>	Polyester
<b>Elongation at 10%</b>	1%
<b>Weight</b>	16.4 lbs per 100'   7.3 kg per 30 m
<b>Spliceable</b>	Yes, Hand

### FEATURES

- Constructed with a polyester sleeve over a nylon core
- Increased energy absorption, allowing you to rig down heavier loads than you normally would on a line of similar strength
- CAUTION though: increased elasticity = more stretch



SKU	FT	PRODUCT
007245	BULK	Polydyne - 1/2"   13 mm
93132ZMH150XB	150'	Polydyne - 1/2"   13 mm
007246	600'	Polydyne - 1/2"   13 mm



SKU	FT	PRODUCT
006600	BULK	Polydyne - 9/16"   14 mm
93136ZMD150XB	150'	Polydyne - 9/16"   14 mm
009814	600'	Polydyne - 9/16"   14 mm



SKU	FT	PRODUCT
007055	BULK	Polydyne - 5/8"   16 mm
93140ZMC150XB	150'	Polydyne - 5/8"   16 mm
007243	600'	Polydyne - 5/8"   16 mm

### FEATURES

- Economical, improved strengths & lower stretch
- High value
- Good handling
- Conformance to sheaves



SKU	FT	PRODUCT
YPB58150	150'	Portland Braid Orange - 5/8"   16 mm
YPB58200	200'	Portland Braid Orange - 5/8"   16 mm
YPB58600	600'	Portland Braid Orange - 5/8"   16 mm



SKU	FT	PRODUCT
YPB34150	150'	Portland Braid Blue - 3/4"   19 mm
YPB34200	200'	Portland Braid Blue - 3/4"   19 mm
YPB34600	600'	Portland Braid Blue - 3/4"   19 mm

# rigging lines

ROPE / RIGGING LINES / DOUBLE-BRAID

## Teufelberger Sirius

Sirius Rigging Bull Rope has been a must-have item in the world of tree care. Arborists in Europe are more familiar with this line than here in the states. The 32-plait polyester sheath makes **Sirius** highly abrasion resistant and easy to knot. With its high-quality kernmantle configuration, the **Sirius** Bull Rope offers excellent value for money and therefore represents a cost-effective alternative. Unique to **Sirius** rope are the overload indicators designed strands set at regular intervals in the rope which show when the rope has been overloaded.

### FEATURES

- Lightweight, high-performance
- Highly abrasion resistant
- Soft hand, strong knot tying capability
- Unique diameter coloring coding scheme
- Excellent value



### SPECS

**Diameter** 15/32" | 12 mm  
**ABS** 7,860 lbs | 3,545 kg  
**Construction** Double-Braid  
**Cover/Core** Polyester/Polyester  
**Elongation at 10%** N/A  
**Weight** 6.9 lbs per 100' | 3.1 kg per 30 m  
**Spliceable** Yes, Hand



SKU	FT	PRODUCT
011509	BULK	Sirius Red - 15/32"   12 mm
C39111200150	150'	Sirius Red - 15/32"   12 mm
C39111200200	200'	Sirius Red - 15/32"   12 mm

**Diameter** 9/16" | 14 mm  
**ABS** 11,700 lbs | 5,181 kg  
**Construction** Double-Braid  
**Cover/Core** Polyester/Polyester  
**Elongation at 10%** N/A  
**Weight** 10.2 lbs per 100' | 4.6 kg per 30 m  
**Spliceable** Yes, Hand

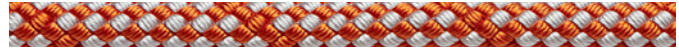

SKU	FT	PRODUCT
C3915-14-00560	BULK	Sirius Orange - 9/16"   14 mm
C3915-14-00150	150'	Sirius Orange - 9/16"   14 mm
C3915-14-00200	200'	Sirius Orange - 9/16"   14 mm

**Diameter** 5/8" | 16 mm  
**ABS** 14,160 lbs | 6,409 kg  
**Construction** Double-Braid  
**Cover/Core** Polyester/Polyester  
**Elongation at 10%** N/A  
**Weight** 12.4 lbs per 100' | 5.7 kg per 30 m  
**Spliceable** Yes, Hand



SKU	FT	PRODUCT
011510	BULK	Sirius Yellow - 5/8"   16 mm
C39161600150	150'	Sirius Yellow - 5/8"   16 mm
C39161600200	200'	Sirius Yellow - 5/8"   16 mm

**Diameter** 11/16" | 18 mm  
**ABS** 17,300 lbs | 7,863 kg  
**Construction** Double-Braid  
**Cover/Core** Polyester/Polyester  
**Elongation at 10%** N/A  
**Weight** 15.3 lbs per 100' | 6.9 kg per 30 m  
**Spliceable** Yes, Hand



SKU	FT	PRODUCT
010457	BULK	Sirius Green - 11/16"   18 mm
C39121800200	200'	Sirius Green - 11/16"   18 mm
C39121800600	600'	Sirius Green - 11/16"   18 mm

**Diameter** 13/16" | 20 mm  
**ABS** 19,700 lbs | 8,990 kg  
**Construction** Double-Braid  
**Cover/Core** Polyester/Polyester  
**Elongation at 10%** N/A  
**Weight** 19.2 lbs per 100' | 8.7 kg per 30 m  
**Spliceable** Yes, Hand



SKU	FT	PRODUCT
009915	BULK	Sirius Blue - 13/16"   20 mm
C3913-20-00150	150'	Sirius Blue - 13/16"   20 mm
7380013	200'	Sirius Blue - 13/16"   20 mm
C3913-20-00600	600'	Sirius Blue - 13/16"   20 mm



## Sterling Atlas

Sterling's dedicated, all-purpose arbor rigging line is made with a polyester sheath for great durability in all conditions. Atlas's braided nylon core provides smooth handling and the ability to absorb dynamic forces. Workhorse of a rigging line.

### SPECS

Diameter	1/2"   13 mm
ABS	11,500 lbs   5,227 kg
Construction	Double-Braid
Cover/Core	Polyester/Nylon
Elongation at 10%	4.1%
Weight	7.9 lbs per 100'   3.6 kg per 30 m
Spliceable	Yes, Hand

Diameter	9/16"   14 mm
ABS	13,750 lbs   6,236 kg
Construction	Double-Braid
Cover/Core	Polyester/Nylon
Elongation at 10%	4.5%
Weight	8.9 lbs per 100'   4 kg per 30 m
Spliceable	Yes, Hand

Diameter	5/8"   16 mm
ABS	19,400 lbs   8,812 kg
Construction	Double-Braid
Cover/Core	Polyester/Nylon
Elongation at 10%	4.5%
Weight	13.5 lbs per 100'   6.1 kg per 30 m
Spliceable	Yes, Hand

### FEATURES

- Smooth handling and the ability to absorb dynamic forces.
- Works with a Port-a-Wrap, capstan winch, or rigging blocks.
- Resists flattening or glazing throughout heavy use.



SKU	FT	PRODUCT
AT130190046	150'	Atlas Green - 1/2"   13 mm
AT130190061	200'	Atlas Green - 1/2"   13 mm
AT130070183	600'	Atlas Green - 1/2"   13 mm



SKU	FT	PRODUCT
011413	BULK	Atlas Red - 9/16"   14 mm
AT140080046	150'	Atlas Red - 9/16"   14 mm
AT140080061	200'	Atlas Red - 9/16"   14 mm



SKU	FT	PRODUCT
AT170090046	150'	Atlas Yellow - 5/8"   16mm
AT170090061	200'	Atlas Yellow - 5/8"   16mm
AT130070183	600'	Atlas Yellow - 5/8"   16mm

## Pelican Matador

Matador Bull Rope combines a polyester cover over a nylon core, creating a high force rope that offers dependability and unsurpassed resistance to abrasion, sunlight and common chemicals. Matador's urethane coating provides an additional UV protection and increased abrasion resistance.

### SPECS

Diameter	5/8"   16 mm
ABS	16,000 lbs   7,272 kg
Construction	Double-Braid
Cover/Core	Polyester/Nylon
Elongation at 10%	7%
Weight	13.1 lbs per 100'   6.0 kg per 30 m
Spliceable	Yes, Hand

Diameter	3/4"   19 mm
ABS	25,000 lbs   11,363 kg
Construction	Double-Braid
Cover/Core	Polyester/Nylon
Elongation at 10%	7%
Weight	17.2 lbs per 100'   7.8 kg per 30 m
Spliceable	Yes, Hand

Diameter	1"   25.5 mm
ABS	45,000 lbs   20,454 kg
Construction	Double-Braid
Cover/Core	Polyester/Nylon
Elongation at 10%	7%
Weight	30.9 lbs per 100'   14 kg per 30 m
Spliceable	Yes, Hand

### FEATURES

- Urethane coating
- Resists abrasions, sunlight & chemicals
- Shock absorbing
- High tensile strength



SKU	FT	PRODUCT
PBR58150	150'	Matador Orange - 5/8"   16 mm
PBR58200	200'	Matador Orange - 5/8"   16 mm



SKU	FT	PRODUCT
PBR34150	150'	Matador Yellow - 3/4"   19 mm
PBR34200	200'	Matador Yellow - 3/4"   19 mm



SKU	FT	PRODUCT
PBR1X150	150'	Matador Red - 1"   25.5 mm
PBR1X200	200'	Matador Red - 1"   25.5 mm

# rigging lines

ROPE / RIGGING LINES / 12-STRAND - HOLLOW BRAID

## Samson AmSteel® Blue

AmSteel offers one of the highest strength-to-weight ratios, floats, has superior flex fatigue and wear resistance. Great choice for chipper or ATV winch lines and other applications requiring extremely high pulling strength. Add a splice with a steel thimble for an additional \$15.00.

### FEATURES

- Stronger than wire rope constructions
- Applications: Climbing and Rigging Accessories, Winch Lines, Logging, Wire Replacement Ropes, General Working Lines



### SPECS

Diameter	5/16"   8 mm
ABS	13,700 lbs   6,227 kg
Construction	12-Strand Hollow Braid
Cover/Core	Samthane SK-75 Coated Dyneema
Elongation at 10%	0.5%
Weight	2.7 lbs per 100'   1.2 kg per 30 m
Spliceable	Yes, Hand



SKU	FT	PRODUCT
006973	BULK	AmSteel Blue - 5/16"   8 mm

Diameter	3/8"   9.5 mm
ABS	19,600 lbs   8,800 kg
Construction	12-Strand Hollow Braid
Cover/Core	Samthane SK-75 Coated Dyneema
Elongation at 10%	0.5%
Weight	3.4 lbs per 100'   1.5 kg per 30 m
Spliceable	Yes, Hand



SKU	FT	PRODUCT
007102	BULK	AmSteel Blue - 3/8"   9.5 mm
007286	150'	AmSteel Blue - 3/8"   9.5 mm
007287	600'	AmSteel Blue - 3/8"   9.5 mm

Diameter	7/16"   11 mm
ABS	23,900 lbs   10,863 kg
Construction	12-Strand Hollow Braid
Cover/Core	Samthane SK-75 Coated Dyneema
Elongation at 10%	0.5%
Weight	4.5 lbs per 100'   2 kg per 30 m
Spliceable	Yes, Hand



SKU	FT	PRODUCT
003377	BULK	AmSteel Blue - 7/16"   11 mm

Diameter	1/2"   13 mm
ABS	34,000 lbs   15,400 kg
Construction	12-Strand Hollow Braid
Cover/Core	Samthane SK-75 Coated Dyneema
Elongation at 10%	0.5%
Weight	5.9 lbs per 100'   2.7 kg per 30 m
Spliceable	Yes, Hand



SKU	FT	PRODUCT
006951	BULK	AmSteel Blue - 1/2"   13 mm





## Samson Tenex-TEC

Tenex-TEC is an economical high-strength, low-stretch rope designed with two ends per carrier. This construction allows for more rope surface conformance to objects being lifted than standard single braid constructions. It is Samthane coated to enhance wear life.

### FEATURES

- Easy to inspect and to splice
- Excellent abrasion resistance
- Firm construction and good grip



### SPECS

<b>Diameter</b>	3/8"   9.5 mm
<b>ABS</b>	6,100 lbs   2,772 kg
<b>Construction</b>	12-Strand Hollow Braid
<b>Cover/Core</b>	Samthane SK-75 Coated Dyneema
<b>Elongation at 10%</b>	1.4%
<b>Weight</b>	4.3 lbs per 100'   2 kg per 30 m
<b>Spliceable</b>	Yes, Hand



SKU	FT	PRODUCT
002043	BULK	Tenex-TEC Blue - 3/8"   9.5 mm

<b>Diameter</b>	1/2"   12 mm
<b>ABS</b>	13,100 lbs   5,954 kg
<b>Construction</b>	12-Strand Hollow Braid
<b>Cover/Core</b>	Samthane SK-75 Coated Dyneema
<b>Elongation at 10%</b>	1.4%
<b>Weight</b>	9.2 lbs per 100'   4.3 kg per 30 m
<b>Spliceable</b>	Yes, Hand



SKU	FT	PRODUCT
004552	BULK	Tenex-TEC Blue - 1/2"   12 mm

<b>Diameter</b>	5/8"   16 mm
<b>ABS</b>	18,800 lbs   8,545 kg
<b>Construction</b>	12-Strand Hollow Braid
<b>Cover/Core</b>	Samthane SK-75 Coated Dyneema
<b>Elongation at 10%</b>	1.4%
<b>Weight</b>	14.8 lbs per 100'   6.6 kg per 30 m
<b>Spliceable</b>	Yes, Hand



SKU	FT	PRODUCT
001188	BULK	Tenex-TEC Red - 5/8"   16 mm

<b>Diameter</b>	3/4"   18 mm
<b>ABS</b>	24,800 lbs   11,200 kg
<b>Construction</b>	12-Strand Hollow Braid
<b>Cover/Core</b>	Samthane SK-75 Coated Dyneema
<b>Elongation at 10%</b>	1.4%
<b>Weight</b>	17.7 lbs per 100'   7.8 kg per 30 m
<b>Spliceable</b>	Yes, Hand



SKU	FT	PRODUCT
000826	BULK	Tenex-TEC Orange - 3/4"   18 mm

## Teufelberger tREX

Teufelberger tREX's hi-vis strands are solution-dyed to prevent loss of color throughout use. Furthermore, it is wax coated, which keeps it from getting rough fast, prevents the 'snagging' typically encountered with such ropes and also increases the rope's service life significantly. Great cordage for rigging tools; straight slings, whoopies, rigging chains, and more!

### FEATURES

- Easy to splice
- Bright color patterns
- Resists fading
- Strong



### SPECS

<b>Diameter</b>	5/8"   16 mm
<b>ABS</b>	14,835 lbs   6,743 kg
<b>Construction</b>	12-Strand Hollow Braid
<b>Cover/Core</b>	Polyester
<b>Elongation at 10%</b>	1%
<b>Weight</b>	13.7 lbs per 100'   6.2 kg per 30 m
<b>Spliceable</b>	Yes



SKU	FT	PRODUCT
011738	BULK	tREX Orange/Yellow - 5/8"   16 mm

<b>Diameter</b>	7/8"   22 mm
<b>ABS</b>	28,779 lbs   13,081 kg
<b>Construction</b>	12-Strand Hollow Braid
<b>Cover/Core</b>	Polyester
<b>Elongation at 10%</b>	12%
<b>Weight</b>	13.8 lbs per 100'   6.27 kg per 30 m
<b>Spliceable</b>	Yes



SKU	FT	PRODUCT
011736	BULK	tREX Orange/Blue - 7/8"   22 mm

# rigging lines

ROPE / RIGGING LINES / 12-STRAND - HOLLOW BRAID

## Yale Ultrex

**Yale Ultrex** is a 12-strand single braid of 100% Ultra High Molecular Weight Polyethylene (UHMPE) fiber enhanced with **Yale's** Maxi-jacket HP coating supplying superior abrasion resistance. Ultrex's braid angles and twist level are designed to optimize break.

### SPECS

<b>Diameter</b>	3/8"   10 mm
<b>ABS</b>	18,000 lbs   8,170 kg
<b>Construction</b>	12-Strand Hollow Braid
<b>Cover/Core</b>	UHMPE
<b>Elongation at 10%</b>	3.5%
<b>Weight</b>	3.5 lbs per 100'   1.6 kg per 30 m
<b>Spliceable</b>	Yes

### FEATURES

- Excellent to pair with Yale's Chook
- Great for static pulling with winches
- Maintains its flexibility even in freezing conditions
- Made in USA



SKU	FT	PRODUCT
009097	BULK	Ultrex - 3/8"   10 mm

## Samson Arbor-Plex

The first synthetic rope designed specifically for the arborist industry, **Arbor-Plex** is a lightweight, dual purpose 12-strand rope that can be used for both climbing and rigging. It resists snagging and has excellent knot-holding ability. **Arbor-Plex** works well when wet and is very durable.

### SPECS

<b>Diameter</b>	5/8"   16 mm
<b>ABS</b>	9,000 lbs   4,090 kg
<b>Construction</b>	12-Strand
<b>Cover/Core</b>	Polyester Blend/Polypropylene
<b>Elongation at 10%</b>	3%
<b>Weight</b>	12 lbs per 100'   5.5 kg per 30 m
<b>Spliceable</b>	No, Sewn

### FEATURES

- Lightweight
- Dual purpose - climbing and rigging line
- Resists snagging
- Excellent knot-holding ability



SKU	FT	PRODUCT
AP58150	150'	Arbor-Plex - 5/8"   16 mm
AP58600	600'	Arbor-Plex - 5/8"   16 mm

<b>Diameter</b>	3/4"   18 mm
<b>ABS</b>	12,000 lbs   5,400 kg
<b>Construction</b>	12-Strand
<b>Cover/Core</b>	Polyester Blend/Polypropylene
<b>Elongation at 10%</b>	3%
<b>Weight</b>	16.2 lbs per 100'   24.1 kg per 30 m
<b>Spliceable</b>	No, Sewn



SKU	FT	PRODUCT
AP34150	150'	Arbor-Plex - 3/4"   18 mm
AP34600	600'	Arbor-Plex - 3/4"   18 mm

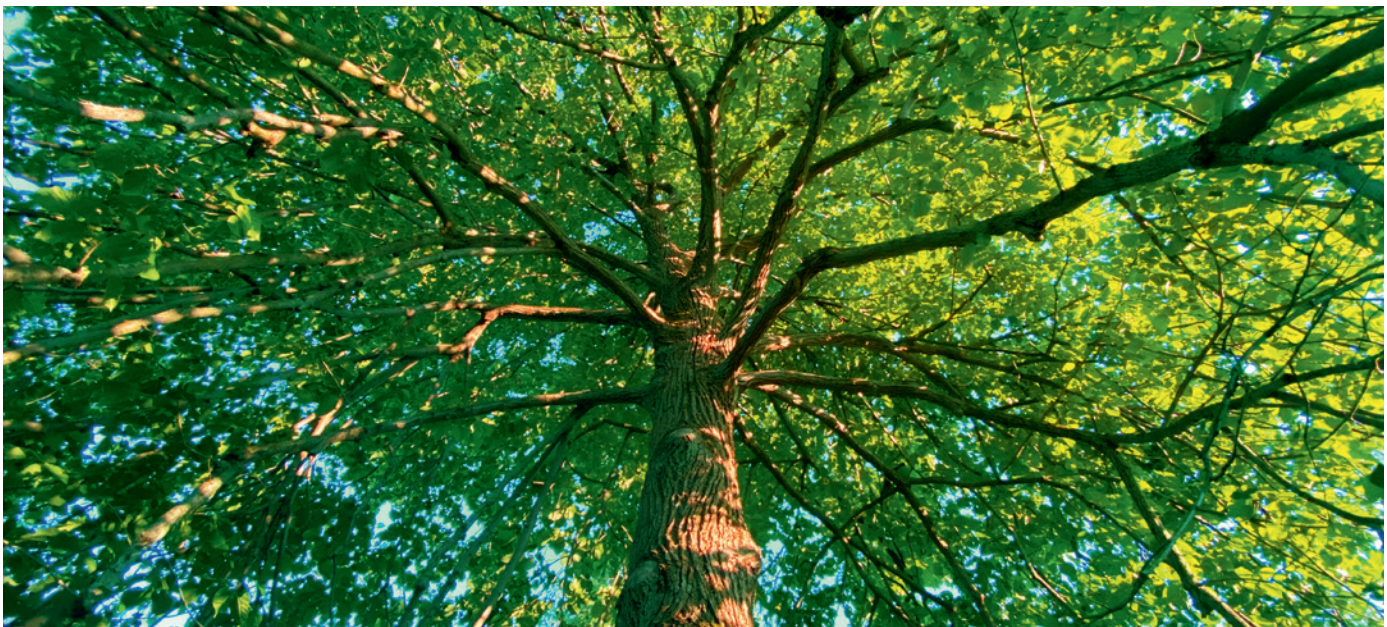



## Samson Pro-Master

**Pro-Master** is a tough, durable, 3-strand rigging rope. It remains firm, round, and flexible with use. It has a soft hand with excellent lock-grip and knot-holding capabilities. Excellent abrasion resistance and UV resistant.

### FEATURES

- Tough, durable
- Soft hand
- Excellent lock-grip
- Superb knot-holding capacity



### SPECS

<b>Diameter</b>	1/2"   13 mm
<b>ABS</b>	5,700 lbs   2,590 kg
<b>Construction</b>	3-Strand
<b>Cover/Core</b>	Polyester Blend/Polyolefin
<b>Elongation at 10%</b>	2%
<b>Weight</b>	7 lbs per 100'   3.2 kg per 30 m
<b>Spliceable</b>	Yes, Hand



SKU	FT	PRODUCT
006422	BULK	Pro-Master - 1/2"   13 mm
PM12150	150'	Pro-Master - 1/2"   13 mm
PM12600	600'	Pro-Master - 1/2"   13 mm

<b>Diameter</b>	5/8"   16 mm
<b>ABS</b>	7,700 lbs   3,500 kg
<b>Construction</b>	3-Strand
<b>Cover/Core</b>	Polyester Blend/Polyolefin
<b>Elongation at 10%</b>	2%
<b>Weight</b>	10 lbs per 100'   4.5 kg per 30 m
<b>Spliceable</b>	Yes, Hand



SKU	FT	PRODUCT
010192	BULK	Pro-Master - 5/8"   16 mm
PM58150	150'	Pro-Master - 5/8"   16 mm
PM58600	600'	Pro-Master - 5/8"   16 mm

<b>Diameter</b>	3/4"   19 mm
<b>ABS</b>	10,000 lbs   4,545 kg
<b>Construction</b>	3-Strand
<b>Cover/Core</b>	Polyester Blend/Polyolefin
<b>Elongation at 10%</b>	2%
<b>Weight</b>	14 lbs per 100'   6.4 kg per 30 m
<b>Spliceable</b>	Yes, Hand



SKU	FT	PRODUCT
PM34150	150'	Pro-Master - 3/4"   19 mm
PM34600	600'	Pro-Master - 3/4"   19 mm



Julie Clements, Certified Arborist, instructing Gretchen Ingersoll; photo by Sydney McNair

# prusiks

## Donaghys Armor-Prus Poly Eye and Eye Hitch Cord Prusik

At long last, a prusik line that will last. **Donaghys Armor-Prus Poly** features a unique cover blend of Technora and Polyester that acts like Armor over a core of light weight Spectra® 900/Kevlar.

### SPECS

Diameter	3/8"   10 mm
ABS	8,600 lbs   4,300 kg
Construction	Double-Braid
Cover/Core	Technora, Polyester blend / Spectra 900, Kevlar
Elongation at 10%	N/A
Weight	2.3 oz. per hitch
Spliceable	Yes, Hand

Diameter	5/16"   8 mm
ABS	5,600 lbs   2,800 kg
Construction	Double-Braid
Cover/Core	Technora, Polyester blend / Spectra 900, Kevlar
Elongation at 10%	N/A
Weight	2.3 oz. per hitch
Spliceable	Yes, Hand

### FEATURES

- Sewn Terminations
- Long lasting, heat resistant
- Pairs great with 7/16" | 11mm lines



SKU	IN	PRODUCT
3412284	28"	Armor-Prus Poly Eye /Eye Hitch Cord - 3/8   10 mm
3412304	30"	Armor-Prus Poly Eye /Eye Hitch Cord - 3/8   10 mm
3412324	32"	Armor-Prus Poly Eye /Eye Hitch Cord - 3/8   10 mm



SKU	IN	PRODUCT
3411284	28"	Armor-Prus Poly Eye /Eye Hitch Cord - 5/16   8 mm
3411304	30"	Armor-Prus Poly Eye /Eye Hitch Cord - 5/16   8 mm
3411324	32"	Armor-Prus Poly Eye /Eye Hitch Cord - 5/16   8 mm
3411404	40"	Armor-Prus Poly Eye /Eye Hitch Cord - 5/16   8 mm

## Sterling Flex

**Sterling's** newest hitch cord is born from arborists' constant requests for ever more durable gear that is also easy to manipulate in all types of weather conditions. Cover provides solid abrasion resistance with enough bite to hitch firmly onto ropes.

### SPECS

Diameter	3/8"   10 mm
ABS	8,767 lbs   4,439 kg
Construction	Double-Braid
Cover/Core	Polyester/Technora®
Elongation at 10%	N/A
Weight	5.3 lbs per 100'   2.4 kg per 30 m
Spliceable	No, sewn eye

Diameter	5/16"   8 mm
ABS	5,418 lbs   2,462 k
Construction	Double-Braid
Cover/Core	Polyester/Technora®
Elongation at 10%	1.8%
Weight	3.6 lbs per 100'   1.6 kg per 30 m
Spliceable	No, sewn eye

### FEATURES

- Ultra-strong and water-resistant polyester fibers surrounded by a blended Technora®/polyester sheath.
- Certs: ANSI Z.133

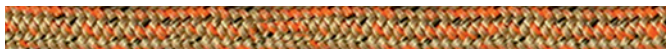

SKU	IN	PRODUCT
SC10AP2E028	28"	Flex - 3/8"   10 mm
SC10AP2E030	30"	Flex - 3/8"   10 mm
SC10AP2E032	32"	Flex - 3/8"   10 mm



SKU	IN	PRODUCT
3523304	30"	Flex - 5/16"   8 mm
3523324	32"	Flex - 5/16"   8 mm



### Samson Bail Out-XL

**Bail Out** is a Double-Braid prusik cord that has a firm feel. It offers the ultimate in heat resistance - it will not melt or flatten out. It is incredibly durable and long lasting. **Bail Out-XL** is the 9 mm product offering, which includes a blue tracer.

**SPECS**

<b>Diameter</b>	3/8"   9 mm
<b>ABS</b>	5,300 lbs   2,409 kg
<b>Construction</b>	Double-Braid
<b>Cover/Core</b>	Aramid/Aramid
<b>Elongation at 10%</b>	1%
<b>Weight</b>	7 lbs per 100'   3.2 kg per 30 m
<b>Spliceable</b>	No, sewn eye

**FEATURES**

- Excellent knot-holding capability
- Firm hand
- Incredibly tough
- Will not flatten out or melt



SKU	FT	PRODUCT
012739	BULK	Bail Out-XL - 3/8"   9 mm

### Teufelberger epiCORD

Cover composed of polyester and Technora® which yields a tight cover that gives you the necessary heat resistance but at the same time flexible enough to easily tie your hitch. Core of **epiCORD** is a combination of Technora and Dyneema® braided for strength and performance.

**SPECS**

<b>Diameter</b>	11/32"   9.3 mm
<b>ABS</b>	7,305 lbs   3,313 kg
<b>Construction</b>	Double-Braid
<b>Cover/Core</b>	Polyester, Technora/Technora, Dyneema
<b>Elongation at 10%</b>	N/A
<b>Weight</b>	4 lbs per 100'   59.5 kg per 30 m
<b>Spliceable</b>	No, sewn eye

**FEATURES**

- Flexibility
- Good knotability
- Very good handling



SKU	IN	PRODUCT
011658	BULK	epiCORD - 11/32"   9.3 mm
3235284	28"	epiCORD - 11/32"   9.3 mm
3235304	30"	epiCORD - 11/32"   9.3 mm

<b>Diameter</b>	3/8"   10 mm
<b>ABS</b>	9,170 lbs   4,159 kg
<b>Construction</b>	Double-Braid
<b>Cover/Core</b>	Polyester/Technora®
<b>Elongation at 10%</b>	1.8%
<b>Weight</b>	4.2 lbs per 100'   62.5 kg per 30 m
<b>Spliceable</b>	No, sewn eye

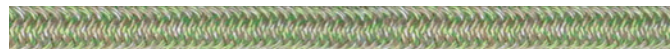

SKU	IN	PRODUCT
3236284	28"	epiCORD - 3/8"   10 mm

### Teufelberger Ocean Polyester

**Ocean Polyester** is Teufelberger's response to the high demands made of hitch cords. **Ocean** is created with a polyester/aramid sheath and polyester core. Thanks to its long service life, the **Ocean Polyester** is great value for your money.

**SPECS**

<b>Diameter</b>	5/16"   8 mm
<b>ABS</b>	4,945 lbs   2,247 kg per 30 m
<b>Construction</b>	Double-Braid
<b>Cover/Core</b>	Polyester, Aramid/ Polyester
<b>Elongation at 10%</b>	N/A
<b>Weight</b>	3.37 lbs per 100'   50.1 kg per 30 m
<b>Spliceable</b>	Yes

**FEATURES**

- Highly abrasion resistant and Heat resistant
- Good grippyness
- Great value for money



SKU	IN	PRODUCT
7350808	33.5"	Ocean Polyester - 5/16"   8 mm

<b>Diameter</b>	3/8"   10 mm
<b>ABS</b>	7,415 lbs   3,370 kg per 30 m
<b>Construction</b>	Double-Braid
<b>Cover/Core</b>	Polyester, Aramid/ Polyester
<b>Elongation at 10%</b>	N/A
<b>Weight</b>	4.75 lbs per 100'   72.1 kg per 30 m
<b>Spliceable</b>	Yes



SKU	IN	PRODUCT
7351007	25.5"	Ocean Polyester - 3/8"   10 mm
7351011	33.5"	Ocean Polyester - 3/8"   10 mm

## Teufelberger HRC ThermaShield

HRC features an extremely heat resistant cover made of Technora® and spun Nomex.® Nomex and Technora cover over a Vectran® core. Excellent for friction hitches with great heat resistance. Popular among professional arborists. No PPE standard, ANSI Z133-2012

### SPECS

<b>Diameter</b>	5/16"   8 mm
<b>ABS</b>	6,000 lbs   2,727 kg
<b>Construction</b>	Double-Braid
<b>Cover/Core</b>	Technora/Nomex/ Vectran
<b>Elongation at 10%</b>	N/A
<b>Weight</b>	3.3 lbs per 100'   47.6 kg per 30 m
<b>Spliceable</b>	Yes

### FEATURES

- Great hand; supple
- Excellent grip
- Non-melting; Non-glazing



SKU	IN	PRODUCT
004329	BULK	HRC ThermaShield - 5/16"   8mm
5WG500800002	24"	HRC ThermaShield - 5/16"   8 mm
012637	26"	HRC ThermaShield - 5/16"   8mm
3231284	28"	HRC ThermaShield - 5/16"   8mm
3231304	30"	HRC ThermaShield - 5/16"   8mm
3231324	32"	HRC ThermaShield - 5/16"   8mm

## Yale Bee-Line

Bee-Line is the first rope designed to wick the heat of friction away from a knot. The "Power of Aramid" is brought to bear in this rope's structure. Technora Aramid fiber has heat resistance through 800 degrees F and excellent cut resistance. Bee-Line uses an Aramid fiber into the rope a higher level of heat can be tolerated without damage to either the cord or the climbing line.

### SPECS

<b>Diameter</b>	3/8"   10 mm
<b>ABS</b>	11,000 lbs   4,990 kg
<b>Construction</b>	Double-Braid
<b>Cover/Core</b>	75% Technora 25% Polyester / Vectran
<b>Elongation at 10%</b>	0.5%
<b>Weight</b>	4.8 per 100'   2.2 kg per 30 m
<b>Spliceable</b>	Yes

### FEATURES

- Vectran, Technora/polyester cover
- Core dependent
- High melt point
- Double-Braid
- Made in USA



SKU	IN	PRODUCT
008104	BULK	Bee-Line - 3/8"   10 mm
3352243	24"	Bee-Line - 3/8"   10 mm
3352284.375	28"	Bee-Line - 3/8"   10 mm
3352304.375	30"	Bee-Line - 3/8"   10 mm
3352323.375	32"	Bee-Line - 3/8"   10 mm

<b>Diameter</b>	5/16"   8 mm
<b>ABS</b>	8,000 lbs   3,629 kg
<b>Construction</b>	Double-Braid
<b>Cover/Core</b>	75% Technora 25% Polyester / Vectran
<b>Elongation at 10%</b>	0.5%
<b>Weight</b>	3.7 lbs per 100'   1.7 kg per 30 m
<b>Spliceable</b>	Yes

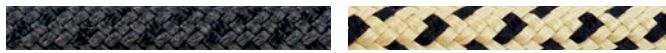

SKU	IN	PRODUCT
5/16BLACK	BULK	Bee-Line - 5/16"   8 mm
3351304	30"	Bee-Line - 5/16"   8 mm
3351324	32"	Bee-Line - 5/16"   8 mm

### HOW TO TIE A VALDOTAIN TRESSE

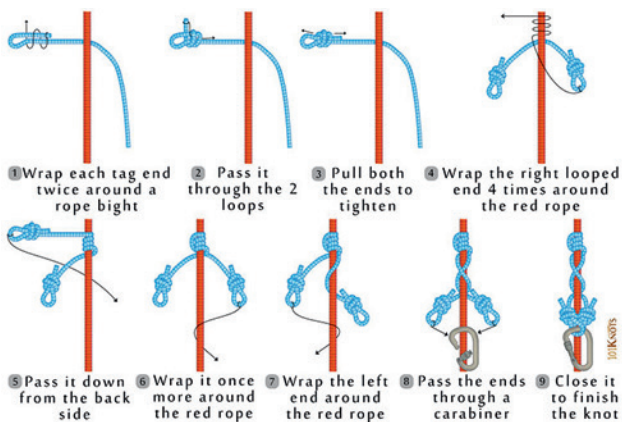

### HOW TO TIE A DISTEL HITCH

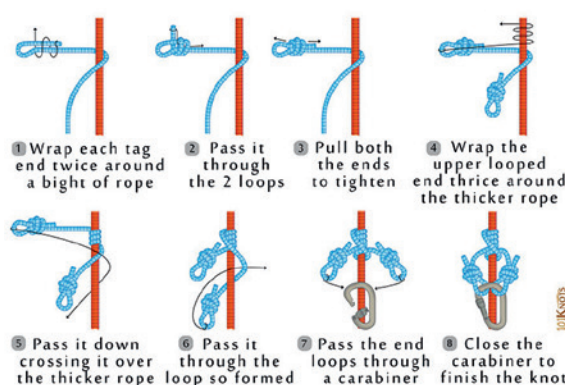



## Sterling RIT

Sterling RIT Hitch Cords provide consistent friction in a wide variety of situation thanks to their firmer, tight Twaron sheaths. The 8 mm version is made from our RIT 500 cord which provides a firm feel and solid durability.

### FEATURES

- Certs: ANSI Z133



### SPECS

Diameter	3/8"   9 mm
ABS	6,968 lbs   3,161 kg
Construction	Double-Braid
Cover/Core	Polyester/Aramid
Elongation at 10%	3.9%
Weight	4.2 lbs per 100'   1.9 kg per 30 m
Spliceable	Yes, Sewn



SKU	IN	PRODUCT
SC09AP2E030	30"	RIT Response- 3/8"   9 mm

Diameter	5/16"   8 mm
ABS	5,418 lbs   2,457 kg
Construction	Double-Braid
Cover/Core	Polyester/Aramid
Elongation at 10%	6.4%
Weight	3.2 lbs per 100'   1.45 kg per 30 m
Spliceable	Yes, Sewn



SKU	IN	PRODUCT
SC08AN2E028	28"	RIT 500 - 5/16"   8 mm
SC08AN2E030	30"	RIT 500 - 5/16"   8 mm
SC08AN2E032	32"	RIT 500 - 5/16"   8 mm





## Samson Tenex-TEC

Tenex-TEC is a high-strength, low-stretch rope designed with two ends per carrier. This construction allows for more rope surface conformance to objects being lifted than standard single braid constructions. It is Samthane coated to enhance wear life.

### SPECS

Diameter	3/8"   9.5 mm
ABS	6,100 lbs   2,772 kg
Construction	12-Strand Hollow Braid
Cover/Core	Polyester
Elongation at 10%	1.4%
Weight	4.3 lbs per 100'   2 kg per 30 m
Spliceable	Yes, hand splice

### FEATURES

- Easy to inspect and splice
- Economical
- Excellent abrasion resistance
- Firm construction with good grip



SKU	IN	PRODUCT
825024806030	BULK	Tenex-TEC - 3/8"   9.5 mm
3/8X24TENEX	24"	Tenex-TEC - 3/8"   9.5 mm
3/8X30TENEX	30"	Tenex-TEC - 3/8"   9.5 mm
3/8X36TENEX	36"	Tenex-TEC - 3/8"   9.5 mm

## Samson Ice Tail

A single carrier 12-strand hollow braid that has a great hand and a soft feel. With excellent grip and high heat-resistance because of the Aramid fibers Ice Tail is a popular choice as a friction hitch cord in climbing systems and progress captures for rigging systems.

### SPECS

Diameter	5/16"   8 mm
ABS	8,500 lbs   3,900 kg
Construction	12-Strand Hollow Braid
Cover/Core	Polyester Blend/Aramid
Elongation at 10%	1.08%
Weight	3.1 lbs per 100'   1.4 kg per 30 m
Spliceable	Yes, 12-Strand Class II

### FEATURES

- Durable and easy to inspect
- Heat resistant
- Soft hand
- Compatibility: favors 7/16" | 11 mm lines



SKU	IN	PRODUCT
006051	BULK	Ice Tail - 5/16"   8 mm
ICETAIL5/16X24	24"	Ice Tail - 5/16"   8 mm
ICETAIL5/16X26	26"	Ice Tail - 5/16"   8 mm
ICETAIL5/16X28	28"	Ice Tail - 5/16"   8 mm
ICETAIL5/16X30	30"	Ice Tail - 5/16"   8 mm
ICETAIL5/16X32	32"	Ice Tail - 5/16"   8 mm
ICETAIL5/16X36	36"	Ice Tail - 5/16"   8 mm





# rope accessories

## Samson Supreme MFP



Made with multi-filament yarns for soft flexibility, **Supreme MFP** is extremely lightweight and it floats. It resists rot, mildew, mold, and most chemicals. Solid braided using quality, high tenacity, multi-filament polypropylene fibers. Reinforced core add strength, and durability. Conforms to U.S. Military Specification #: A-A-55622B.

GREAT FOR REPLACING PRUNING CORD  
FOR YOUR PRUNER/LOPPER HEADS

### SPECS

<b>Diameter</b>	5/16"   10 mm
<b>ABS</b>	1,300 lbs   590 kg
<b>Construction</b>	12-Strand Solid Braid
<b>Cover/Core</b>	Polypropylene
<b>Weight</b>	1 lb per 100'   0.5 kg per 30 m
<b>Spliceable</b>	No



### FEATURES

- Lightweight with low stretch
- Knots easily
- UV stabilized, Rot/Mildew Resistant
- Great for pole pruner heads, tie downs, flagpoles, and other general use needs

SKU	FT	PRODUCT
000547	BULK	Supreme MFP - 5/16"   10 mm

## Sterling Glo-Cord

A great accessory cord with a bonus of a reflective tracer braided into the sheath. This makes Glo-Cord highly visible when light hits it, making it ideal for low light conditions.



### FEATURES

- Glows in the dark with reflective strand
- Great for zipper pulls, rope bags and gear pack pulls, and for your treeboat rain fly support line

### SPECS

<b>Diameter</b>	1/8"   2.75 mm
<b>ABS</b>	270 lbs   122.7 kg
<b>Construction</b>	Double-Braid
<b>Weight</b>	8 oz per 100'   68 g per 30 m

SKU	FT	PRODUCT
010328	50'	Glo-Cord Black - 1/8"   2.75 mm
010329	50'	Glo-Cord Orange - 1/8"   2.75 mm
010330	50'	Glo-Cord Yellow - 1/8"   2.75 mm
010331	50'	Glo-Cord Blue - 1/8"   2.75 mm

## Marlow Whipping Twine #4

**Marlow's Wax Polyester Whipping Twine** is widely regarded as the best whipping twine on the market.



### SPECS + FEATURES

- Material: Waxed Polyester
- Good strength
- Length: 134'

SKU	ATTRIBUTE	PRODUCT
TAE003	Blue	134' Whipping Twine #4
TAE016 BLACK	Black	134' Whipping Twine #4
TAE015	Gold	134' Whipping Twine #4
TAE004	Green	134' Whipping Twine #4
TAE002	Red	134' Whipping Twine #4





ROPE / ACCESSORIES

## Whipping Twine, Waxed #7 with #14 Needle

### SPECS + FEATURES

- White polyester, waxed whipping twine
- #14 Needle
- Made in USA



SKU	ATTRIBUTE	PRODUCT
000607	1 oz	Whipping Twine w/Needle #7
007770	4 oz	Whipping Twine w/Needle #7

## Shrink Tubing Clear

2:1 shrink ratio heat shrink tubing in the most popular diameter sizes, made from a variety of high performance polymers for your diverse applications, requirements and environments, meeting all applicable industry specifications.

Uniquely packaged and clearly labeled in industrial-grade, unbreakable storage containers.



SKU	ATTRIBUTE	PRODUCT
SHRINKTUBING	3/4" / FOOT	Shrink Tubing Clear 3/4"
SHRINKTUBING 1	1" / FOOT	Shrink Tubing Clear 1"





### ARS Scissors

These ARS scissors have short-blades and high-leverage which are perfect for general rope splicing tasks with great precision and comfort. Hard chrome plating offers greater hardness, rust proofing, sharp looks and precision. The comfortable, universal fit, soft bow grips help prevent fatigue during use.

**SPECS + FEATURES**

- Overall Length : 160 mm
- Overall Weight : 60 g

SKU	ATTRIBUTE	PRODUCT
SS3000		ARS Scissors



### Samson Splicing Kit

The **Samson Splicing Kit** comes with instructions for a double-braid eye splice. Full of useful splicing tools. Great for splicing 12-strands like **Tenex** as well, up to 1/2" in diameter.

**SPECS + FEATURES**

- 5 tubular aluminum fids (sizes 1/4", 5/16", 3/8", 7/16" and 1/2")
- Small pusher
- Convenient, plastic storage tube

SKU	ATTRIBUTE	PRODUCT
9990070	Long	Samson Splicing Kit



### Round Rope Thimble

**SPECS + FEATURES**

- Diameter: 1/2"
- Material: Plastic

SKU	ATTRIBUTE	PRODUCT
350410	1/2" Green	Rope Thimble Plastic Round



Thimble only, additional items shown not included.



Photo courtesy of Samson





Image courtesy Northern Arboriculture,  
Tyler setting up gear





# 3 | storage

ROPE + GEAR BAGS.....	88
THROWLINE STORAGE.....	97



# rope + gear bags

## BUCK Hard Bottom Rope Bag

This lightweight **BUCK Rope Bag** is made for hauling rope and keeping your rope out of weather conditions when not in use.

### SPECS + FEATURES

- Canvas construction with plastic bottom
- Drawstring closure top and two large reinforced nylon carry handles
- Durable rubber bottom with gliders to help maintain form and keep bag off the ground preventing moisture from seeping in through the bottom
- 15" H x 12" W
- Capacities vary by selection; 5/8" climbing or rigging line
- Made in USA

SKU	SIZE	COLOR	PRODUCT
45691R2-150	150'	Red	Rope Bag - Hard Bottom



## BUCK Rope Bag with Pockets

Simple rope bag, solid built, and a work horse.

### SPECS + FEATURES

- Capacities vary by selection; 5/8" climbing or rigging line
- Outside pockets: 4
- Webbing handles
- Drawstring closure tab
- Colors vary by selection
- Made in USA

SKU	SIZE	COLOR	PRODUCT
4569B1P-150	150'	Blue	Rope Bag with Pockets
4569B1P-200	200'	Blue	Rope Bag with Pockets
4569B1P-250	250'	Blue	Rope Bag with Pockets
4569G5P-120	120'	Green	Rope Bag with Pockets
4569G5P-150	150'	Green	Rope Bag with Pockets
4569O2P-150	150'	Orange	Rope Bag with Pockets
4569PR2-150	150'	Red	Rope Bag with Pockets
4569PR2-200	200'	Red	Rope Bag with Pockets
4569PR2-225	225'	Red	Rope Bag with Pockets



## BUCK Mesh Rope Bags

This **Mesh Rope Bag** is made from heavy duty see through mesh and will carry 150' - 225' of 1/2" rope based on size purchased. The mesh material also allows sufficient airflow through the bag which aids in drying wet ropes.

### SPECS + FEATURES

- See through design provides airflow
- Soft bottom or Hard bottom protection from ground moisture
- Capacities vary by selection; 1/2" climbing or rigging line
- Made in USA

SKU	SIZE	COLOR	PRODUCT
45691G1-200	200'	Green	Mesh Rope Bag - Hard Bottom
45691G1-225	225'	Green	Mesh Rope Bag - Hard Bottom
4569G1-150	150'	Green	Mesh Rope Bag - Soft Bottom







## BUCK Haul Bag

Heavy duty, rugged haul bag with shoulder/back straps designed for arborists, tower worker, and rope technicians. MOLLE webbing on the exterior and interior of the bag provides organization.

### SPECS + FEATURES

- 44 oz vinyl construction
- Metal buckles and snaps with drawstring closure tab
- Ergonomic back pad that easily removes for travel or storage.
- Climbing spec webbing used to reinforce all seams and wear points with an inside mesh pocket for extra storage and one outside pocket
- 28" H x 16" W x 27" Depth
- Weight 3.9 lbs
- Made in USA

SKU	SIZE	COLOR	PRODUCT
4370B14	XL	Black	Haul Bag
4371B14	L	Black	Haul Bag



## BUCK Rope Backpack Bag



The **Buck Backpack Rope Bag** is perfect for rope hauling, the easy access drawstring creates a functional access point to your rope. QC chest strap that helps maintain position and comfort of bag while climbing. 3 outside mesh pockets with hook and loop closure allows user to find hardware and equipment fast and efficiently.

### SPECS + FEATURES

- Quick adjust friction buckles allow for easy adjustment of straps to find a great fit.
- The fairlead drawstring allows for a secure closure and a carry handle, provides alternative grab and carry.
- Fits: 150' of 1/2" climbing or rigging line
- Padded shoulder straps
- Drawstring closure tab
- Made in USA

SKU	SIZE	COLOR	PRODUCT
4469G5150	150'	Blue	Rope Backpack Bag



## BUCK Deployment Bag



This sizable **BUCK Deployment Bag** allows storage for throwline, tools, 120' of **Samson Velocity** and more.

### SPECS + FEATURES

- Sturdy cordura bag
- Drawstring top
- Ring to hang onto harness
- Offered in 2 sizes - Small (8" x 10") or Large (8" x 12")
- Made in USA

SKU	SIZE	COLOR	PRODUCT
000450	8"x10"	Blue	Deployment Bag Small
006764	8"x12"	Blue	Deployment Bag Large



# rope + gear bags

STORAGE / ROPE + GEAR BAGS

## BUCK Mesh Equipment Bag



Easily to locate items within this Hi-Vis Green bag. Small stores equipment from small tools and gear. Large bag that stores equipment from small tools and hardware to saddles, rope, and climbers. Great for those OCD arborist who like to organize your gear like your speed line kit.

### SPECS + FEATURES

- 1" Nylon Web Handles
- Zipper Closure with YKK oversized zipper
- Airflow allows for equipment to dry while being stowed
- Small - 5" Diameter x 9" Length; Large - 5" Diameter x 12" Length
- Made in USA

SKU	SIZE	COLOR	PRODUCT
45400G109	9"	Hi-Vis Green	Mesh Equipment Bag Small
45400G112	12"	Hi-Vis Green	Mesh Equipment Bag Large



## BUCK Tool Ditty Bag



BUCK's equipment storage bag is a an easy way to keep track of your gear.

### SPECS + FEATURES

- Offered in 2 harness attachment options: rings or snaps
- Large heavy duty elastic opening
- Have easy accessible storage for your tools, snacks, camera, phone and more
- Made in USA

SKU	ATTRIBUTE	PRODUCT
45702D1G4	D-Ring	Tool Ditty Bag - Rings
45702G4S2	Snaps	Tool Ditty Bag - Snaps



## Arbortec AT101 Mamba Mini Kit Bag

Organize your gear. A mini bag to stop valuable climbing devices from getting tangled up and knocked around with all your other gear.

### SPECS + FEATURES

- 3 liter capacity
- Zippered lid
- Bright colors - easy to locate
- Size: 25cm (L) x 14 cm (W) x 13 cm (H)

SKU	SIZE	COLOR	PRODUCT
AT101PINK	3 L	Pink	Mamba Mini Pink
AT101GREEN	3 L	Green	Mamba Mini Green

GREAT SMALL WATERPROOF BAG TO KEEP YOUR GEAR CONTAINED WITH HIGH VISIBILITY



## Arbortec Mamba DryKit Rope Bag

Keep your gear clean, tidy, and organized with the new **DryKit** gear bags from **Arbortec**. Made from robust PES/PVC Tarpaulin material with heavy duty stitching and accessories.

### SPECS + FEATURES

- Large inner mesh pocket on each end, inside lid, and front zippered mesh pocket
- Key-safe clip inside lid pocket
- Large cover with overlapping water resistant edge
- Carabiner loops on both sides
- Removable solid base and rucksack straps
- Large shoulder strap with 6 attachment points
- Extra tie-down straps over lid for external stowage or/and added lid security
- Reinforced rubber pull/carry handles on each end.

SKU	SIZE	COLOR	PRODUCT
AT101-70 BC	70 L	Blue	Mamba Rope Bag Blue
AT101-70 LI	70 L	Lime	Mamba Rope Bag Lime
AT101-70 BK	70 L	Black	Mamba Rope Bag Black



DUFFEL BAG STYLE WITH SHOULDER STRAP AND BACKPACK STRAPS!



## CAMP Wagon 20 L Rope Bag

Bucket bag for carrying and hauling tools. Constructed from robust Tarpaulin PVC 500D with high-frequency welding.

### SPECS + FEATURES

- 3 metal rings are designed for clipping to a harness or suspending from a rope
- Semi-rigid construction keeps the bucket open during use
- Closure hood stows away in a pocket when not in use
- 2 external pockets and wide interior pockets with gear loops for organization
- 2 hauling handles
- Weight: 1100 g | 38.8 oz
- Dimensions: ≈ 32 cm x 38 cm

SKU	SIZE	COLOR	PRODUCT
278420L	20 L		Wagon 20 L Rope Bag



## CAMP Trucker Backpack

Roll top backpack constructed from Tarpaulin PVC 500D with high-frequency welding.

### SPECS + FEATURES

- Padded back and shoulder straps
- 1 external zip pocket and 1 external zip opening allows access to the lower half of the main compartment
- Transparent label pocket. Interior zip pocket, gear loops and loops for fastening rope ends.
- Hauling handle and 2 side loops for loads up to 50 kg.
- 30 L Dimensions: ≈ 32 cm x 49 cm
- 45 L Dimensions: ≈ 34 cm x 62 cm
- 60 L Dimensions: ≈ 37 cm x 64 cm

SKU	SIZE	COLOR	PRODUCT
2786 30L	30 L		Trucker 30 L Backpack
2787 45L	45 L		Trucker 45 L Backpack
2788 60L	60 L		Trucker 60L Gear Backpack



## Weaver Collapsible Basic Rope Bag

Handy bags help keep rope coiled, tangle-free and protected. Made from 1,200-denier polyester, these bags feature spiral wire that's attached to the exterior of the bag to help prevent it from collapsing.

### SPECS + FEATURES

- Webbing straps with quick-release buckles that can be used to adjust height of bag or collapse bag when not in use.
- A scissor snap offers easy attachment to belt.
- The convenient drawstring top closure provides quick and easy access.
- Dimensions 12" D x 14"H
- Capacity: 150' of 1/2" or 9/16" rope
- Volume: 26 L

SKU	SIZE	COLOR	PRODUCT
0807152	150'	Blue	Collapsible Basic Rope Bag
0807152RD	150'	Red	Collapsible Basic Rope Bag



# rope + gear bags

STORAGE / ROPE + GEAR BAGS

## Weaver Backpack Rope Bag

This handy **Backpack Rope Bag** is durably-constructed of 1,200-denier polyester and easy to take to the job site.

### SPECS + FEATURES

- Padded shoulder straps for comfortable hands-free carrying
- A cross strap with a quick-release buckle attaches to two shoulder straps across the chest for added stability.
- 2 roomy outside pockets for added storage
- Drawstring top closure for quick and easy access
- Measures: 12" D x 14" H
- Capacity: 150' of 1/2" or 9/16" rope

SKU	SIZE	COLOR	PRODUCT
08-07180-RD	150'	Red	Backpack Rope Bag



ECONOMICAL, WELL BUILT,  
LOTS OF FEATURES

## Weaver Red Zippered Rope Bag

### SPECS + FEATURES

- Constructed of 1,200-denier polyester
- Spiral wire attached to the exterior of the bag to help prevent it from collapsing
- Quick-release buckles keep bag collapsed when not in use
- 1" Ring offers easy attachment
- 2 outside pockets with snap closures for storage
- Top of bag features a zippered closure
- Grommet for feeding rope is reinforced with leather for extra durability and is covered with a flap that keeps weather out
- Measures: 11" D x 15" H
- Capacity: 150' of 1/2" rope

SKU	SIZE	COLOR	PRODUCT
08-07156-RD	150'	Red	Zippered Rope Bag



## Weaver All Purpose Gear Backpack

**Weaver's backpack** is a large, versatile bag allows you to comfortably carry all necessary equipment. 1200-denier polyester bag allows you to carry your positioning saddle, helmet, hand saw, rope, and all accessories.

### SPECS + FEATURES

- Zipper down the side of the bag allows easy access to your equipment.
- Roomy, zippered outside compartment offers added storage.
- Hand saw pouch keeps your saw away from your climbing rope and features a hook and loop closure.
- Designed with mesh for breathability.
- Padded shoulder straps offer comfortable hands-free carrying and are angled for a better fit.
- Cross strap with a quick-release buckle attaches to two shoulder straps across the chest for added stability.
- Padded for comfort to back.
- Measures: 15" D x 29" H

SKU	COLOR	PRODUCT
0807185	Blue	All Purpose Gear Backpack



BIG BLUE, SIMPLY  
HOLDS A LOT.



## Weaver Arborist Doctor-Style Polyester Tool Bag

Durably-constructed, water-resistant, 1,000-denier polyester bag with a PVC coating making this bag stand up on its own, yet flexible enough to collapse.

### SPECS + FEATURES

- Hinged mouths that open wide for easy access to the contents
- Hard plastic bottom protects contents and helps prevent punctures
- Hook and loop closures at top for easy in and out, reinforced adjustable leather straps for added security, and a rain shield cover for protection from the elements
- (2) 18" W x 12" H x 4" D side pockets with hook and loop closures
- Elastic daisy chain in one side pocket securely stores carabiners
- Webbed handles and an adjustable shoulder strap with pad for added comfort

SKU	COLOR	PRODUCT
08-07001	Yellow	Arborist Doctor-Style Polyester Tool Bag



## Weaver Arborist Rope Bag **NEW**

Heavy-duty design is reinforced at the top with a band of our exclusive Brahma Webb® coated webbing to help the bag stay open for easy loading.

### SPECS + FEATURES

- Constructed from durable, 630-denier polyester with a weather resistant coating
- Plastic stiffeners fortify the sides, providing additional support and preventing bag from collapsing during loading
- Convenient drawstring top closure for quick and easy access
- Soft nylon handles ensure easy, comfortable carrying
- Charcoal material accented with green or pink logo and stitching
- Small bag measures 11" in diameter x 14" high with a 22-liter carrying capacity
- X-Large bag measures 15" in diameter x 19" high with a 55-liter carrying capacity

SKU	COLOR	SIZE	PRODUCT
08401-40-22	Charcoal/Pink	Small	Arborist Rope Bag
08401-70-22	Charcoal/Pink	X-Large	Arborist Rope Bag
08401-40-27	Charcoal/Green	Small	Arborist Rope Bag
08401-70-27	Charcoal/Green	X-Large	Arborist Rope Bag



CHARCOAL/GREEN  
X-LARGE



CHARCOAL/PINK  
SMALL



## Weaver Cavern Gear Bag **NEW**

Comfortably carry all climbing gear with this versatile, heavy-duty gear bag featuring a padded back, removable cover and specialized storage.

### SPECS + FEATURES

- Constructed with heavy-duty tarpaulin for waterproof, mildew-resistant and tear-resistant performance
- Removable cover with buckle closures keeps your gear inside and protected from the elements
- Outside pockets include a specialized handsaw pocket, two pockets with buckle closures, and a zippered front pocket with internal divider and daisy chain
- Adjustable backpack straps and a padded back pad make it easy to take this bag from truck to tree
- Hang gear and carabiners on four rows of daisy chain
- A set of top handles and a reinforced side handle give you additional carrying options
- Reflective piping provides enhanced visibility in low-light conditions
- Capacity: 70-liter; Dimensions: 24" high x 11" deep x 15" wide

SKU	COLOR	PRODUCT
08410-00	Black	Cavern Gear Bag



NEW BAG!

Bag only, additional items shown not included.



# rope + gear bags

STORAGE / ROPE + GEAR BAGS

## DMM Transit Rope Bag 45L

DMM's 45 L rope bag is large and strong. Made from heavy duty Tarpaulin for strength and durability.

### SPECS + FEATURES

- Draw cord closure
- Removable rucksack straps
- Daisy chain outside webbing for kit connection
- Vinyl front pocket for documents
- Interior pocket and tie off loops to tie rope ends
- Top compression straps for additional kit
- Reflective piping and logo for retrieval in low light conditions
- Dimensions: 15.75" W x 15.75" H | 40 cm W x 40 cm H

SKU	SIZE	PRODUCT
B122BLK-45	45 L	Transit Rope Bag 45L



## New Tribe Medium Rope Bag

### SPECS + FEATURES

- Two handles and reinforced rims and sides
- Made of 1000 denier nylon canvas
- Firm webbing for stiffness and durability
- Pack cloth top with drawstring closure
- Steel ring at rim and inside bottom webbing loop
- Capacity: Holds 150' of 1/2" arborist rope, or 7/16" static
- Measures: 12" wide x 11" high

SKU	COLOR	PRODUCT
71030	Forest green	Medium Rope Bag



## New Tribe Open Climb Bucket Bag

Designed to snap securely into any saddle belt, **New Tribe's Climb Buckets** can carry your small gear like lanyards, pulleys, grapnel, gloves, camera.

### SPECS + FEATURES

- Webbing-reinforced rim that makes for quick easy access to its contents
- Easy to mount on any style belt
- Rigid webbing tab that fastens with both Velcro and a steel snap
- Measures: 8" x 11" x 2"

SKU	COLOR	PRODUCT
29220	Black	Open Climb Bucket Bag



## New Tribe Zippered Climb Bucket

Designed to snap securely into any saddle belt, **New Tribe's Climb Buckets** can carry your small gear like lanyards, pulleys, grapnel, gloves, camera.

### SPECS + FEATURES

- Zipper closure
- Can be mounted on any kind of belt using a rigid webbing tab that fastens with both velcro and a steel snap
- Dimensions: 6" x 10" x 2-1/2"

SKU	COLOR	PRODUCT
29320	Black	Zippered Climb Bucket



PHONE OR SNACKS  
AREN'T JUMPING  
FROM THIS  
ZIPPERED POUCH!





## Edelrid Kurt Haulbag

Robust 55 liter, ultrasonically welded carry system with EVA foam padding for comfortably carrying heavy loads. The **Kurt Haulbag** is great for hauling gear from the truck to the job site.

### SPECS + FEATURES

- Interior is light, easier to see your gear inside
- Robust, abrasion-resistant tarpaulin with drainage holes
- Inside pocket for accessories
- 4 gear loops inside for gear organization
- Stowable haul straps in the main compartment
- 2 loops for hauling the haulbag
- Weight: 1000 g | 2.2 lbs

SKU	COLOR	PRODUCT
721210556450 55L	Snow/Oasis	Kurt Haulbag



EDELRID

## Edelrid Mini Tool Bag - Small pocket bag

The **Mini Tool Bag** by Edelrid is an easy-to-organize and comfortable-to-carry pocket bag for tools or camera lens.

### SPECS + FEATURES

- Flexible pockets for practically storing tools
- Made from robust tarpaulin
- Interior attachment options for carabiners
- Weight: 150 g
- Color: Night/Oasis

SKU	SIZE	PRODUCT
721060000170 3L	3 L	Mini Tool Bag 3L



LIGHT INTERIOR  
MEANS NO MORE  
"HUNTING" FOR GEAR



EDELRID

## Edelrid Medium (9L) Tool Bag

EDELRID

Great adjustable bag for so many applications; pockets can be removed or rearranged for maximum suitability for tasks: speedline kit, rigging bag, pruning tools, and more.

### SPECS + FEATURES

- 4 flexible and movable (velcro) pockets for practically storing tools or camera lenses
- Part mesh top for airflow and robust tarpaulin material
- Weight: 690 g | 1.52 lbs
- Color: Night/Oasis

SKU	SIZE	PRODUCT
721260090170	9 L	Medium Tool Bag 9L



ORGANIZE YOUR RIGGING BLOCKS,  
SLINGS, HARDWARE, AND MORE!

## Kong Rope Bag Backpack 100

KONG

Backpack for carrying ropes and equipment with comfortable padded shoulder straps and hook for suspension.

### SPECS + FEATURES

- Angled closing flap with ring for suspension
- Drawstring closure and rapid clip made of ultra-durable nylon
- Transparent side pocket for name plate label
- Interior pocket with zip for storing small tools.
- Made of extremely durable PVC; reinforced bottom with slotted holes for breathability and handle for the emptying.
- Capacity: 28 L; Holds 100 meters of line

SKU	PRODUCT
982501000KK	Kong Rope Bag Backpack 100



# rope + gear bags

STORAGE / ROPE + GEAR BAGS

## Sterling Rope Bag



**Sterling Rope Bags** have padded backpack straps for easy hauling, a clear front pocket to store a rope log, and a cinch top closure.

GREAT FOR NOTING OWNER OR NAME OF ROPE, IT'S PROPER USE AND STRENGTH AND MORE.

### SPECS + FEATURES

- Made of durable nylon
- Equipped with top handles
- Bottom grommet for drainage
- Clear front pocket for logs, owner, contents, or notes
- Adjustable shoulder straps on the medium bag
- Volume: Small 17 L, Medium 31 L
- Capacity: Small: 200' of 3/8" Small; Medium: 200' of 1/2"

SKU	SIZE	COLOR	PRODUCT
MDBAGROPES09	Small	Yellow	Sterling Rope Bag
MDBAGROPEM07	Medium	Orange	Sterling Rope Bag



## Heavy-Duty Rope and Gear Backpack

**PELICAN ROPE**  
The Most Trusted Name in Rope®

This heavy-duty 900D denier construction rope bag is comfortable, durable, and lightweight. High quality main pocket w/ front pocket zippers, and large, separate gear pocket.

### SPECS + FEATURES

- Dual side water pockets
- Padded shoulder straps
- MOLLE webbing loops for carabiners
- Holds 200' of 1/2" rope
- 10.8" x 20" x 8.3"

SKU	PRODUCT
RB12X18	Heavy-Duty Rope and Gear Backpack



Bag only, additional items shown not included.





# throwline storage

## Falteimer Throwline Cube

The **Falteimer Folding Cube** is the platinum standard in the cube market. In a matter of seconds, this handy triangle becomes a cube-shaped folding box which is 43 cm wide. The size of the opening makes it much easier to throw the line from and to flake back in.

### SPECS + FEATURES

- Employed and deployed in a matter of seconds.
- Throw lines and weight bags have separate inside pouches and are firmly held once the bag is collapsed.
- The carry velcro strap and clip makes this cube perfect for transport.

SKU	PRODUCT
FFC DOUBLE FLOOR	Cube Double Floor
FALTEIMER	Cube Single Floor



Cube only, additional items shown not included.

YOUR VOICE WAS HEARD - THE DOUBLE FLOOR LETS YOU KEEP 2 SYSTEMS IN ONE CUBE!

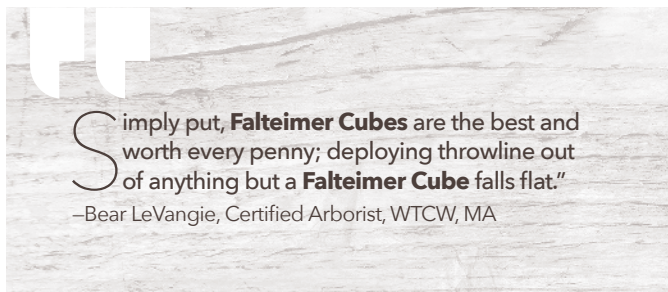

## Weaver Throwline Cube



**Weaver's throwline cube** organizes and stores throw lines and weights in a roomy cube that folds down to a compact triangle.

### SPECS + FEATURES

- Durable constructed cube offers plenty of storage with a roomy outside pocket and two smaller interior pockets.
- Affordable and great for both aerial and ground arborists
- End of throw line secures with a hook and loop strap and D-ring.
- Measures: 16-1/2" (collapses to a small triangle)

SKU	PRODUCT
08-07190	Weaver Throwline Cube



## Weaver Throwline Bucket Bag



This unique bag features separators that allow you to store and protect multiple throw lines and weights in one bag. Constructed from 1,200-denier polyester, this bag will hold four various-sized bags and throw lines.

### SPECS + FEATURES

- Rain shield and a convenient drawstring closure for easy access
- Handy separators are included to ensure lines will not get tangled
- Multiple inside pouches with hook/loop closures for easy storage
- Interior features 4 floating D-rings to help manage the line ends
- 2 handy external pockets offer added storage options
- 1 external pocket has a clear pocket for easy labeling
- Measures: 12" in diameter x 8" high

SKU	PRODUCT
08-07165-RD	Weaver Throwline Bucket Bag



Bag only, additional items shown not included.

# throwline storage

STORAGE / THROWLINE STORAGE

## Weaver Throwline Storage Bag

### SPECS + FEATURES

- Constructed of 600-denier coated polyester
- Convenient drawstring top closure
- Interior nickel plated rings to tie ropes to and exterior nickel plated rings for easy attachment to a work belt saddle or rope
- 2 Sizes: Small size holds 150'; Medium size holds 200'
- Small (4" D x 6" high)
- Medium (7" D x 9" high)

SKU	PRODUCT
0807140	Weaver Throwline Storage Bag - Small
0807142	Weaver Throwline Storage Bag -Medium



Bag only, additional items shown not included.

## BUCK Throwline Deployment Bag

**Throwline Deployment Bag** allows multiple throw lines to be stored in one bag without tangling by providing four inside floating D-rings as tying off points.

### SPECS + FEATURES

- 3 outside pleated mesh pockets with hook/loop closures to secure contents
- 4 inside mesh pockets for easy throw bag storage
- 4 inside floating D-rings for tying off throwlines
- Outside clear pocket for labeling contents
- Sewn in PVC ring to keep the top of the bag open
- 9" H x 12" D
- Add a Deployment Bag Frisbee Separator (44R1)

SKU	PRODUCT
4468G9	Throwline Deployment Bag
44R1	Throwline Deployment Bag Frisbee Separator



## New Tribe's Line Mug

A handy little drawstring closure gear bag, for use where a compact bag is all you need. Carry either essentials or throwline.

### SPECS + FEATURES

- External D-ring at the rim for attachment to your saddle or use to tether
- Webbing strap serves as a handle, or as a loop onto a belt for carrying
- Plastic swivel snap hook on rim
- Internal webbing loop
- 6" tall x 5" in diameter

SKU	COLOR	PRODUCT
29620	Black	New Tribe's Line Mug
29626	Red	New Tribe's Line Mug
29628	Camo	New Tribe's Line Mug



GREAT FOR  
HUNTERS TOO!  
STURDY LITTLE  
GEAR BAG



# 4 | harnesses



Image courtesy of Edelrid TreeRex

HARNESS CROSS REFERENCE .....	100
POSITIONING .....	101
ACCESSORIES .....	115
FALL ARREST + UTILITY .....	123
FALL ARREST LANYARDS .....	126

# harness cross reference

HARNESS/PRODUCT	SIZING	WEIGHT	BRIDGE TYPE	LEG/BATTEN	OPTIMAL SYSTEM*	PAGE
Arbortec TreeHog TH5000 <sup>W</sup> Razorback Leg Harness	S, M/L	4.5	Webbing	Leg/Batten	MRS	114
Arbortec TreeHog TH7000 <sup>W</sup> Batten Seat Harness	S, M/L	4.5	Webbing	Batten	MRS	114
BUCK 1371 – Economy Saddle <sup>W</sup>	S-XL	7.1	2 D Rings	Soft Batten	MRS	105
BUCK Ergovation Saddle <sup>FW</sup>	XS-XL	6.8	Rope/Web/D	Leg or Batten	SRS, MRS	104
BUCK 1480 – Agility Saddle <sup>W</sup> <b>NEW</b>	XS-XL	5.8	Rope Chain	Leg	SRS, MRS	104
CAMP Tree Access EVO <sup>FW</sup>	1, 2	4.4	Webbing	Leg (Batten add on)	SRS, MRS	101
Teufelberger treeMOTION EVO <sup>W</sup>	One Size	6	Double Bridge (Rope)	Leg	SRS, MRS	102
Teufelberger treeMOTION Super Light <sup>W</sup>	One Size	4	Rope	Leg	MRS	102
Weaver Denali <sup>W</sup>	One Size	6.5	Rope	Leg	SRS, MRS	107
Weaver Cougar WLC-700 <sup>W</sup> Web Bridge with Legs	S-XL	4	Webbing	Leg	MRS	106
Weaver Cougar WLC-730 <sup>W</sup> Web Bridge with Batten	S-XL	8.3	Webbing	Leg/Batten	MRS	107
Weaver WLC-300 <sup>W</sup> Double D Wide Back	S-XL	6.1	2 D Rings	Leg	MRS	108
Weaver WLC-330 <sup>W</sup> Floating D Wide Back	S-XL	6.05	1 Floating D Ring	Leg	MRS	108
Weaver WLC-130 <sup>W</sup> Floating 2D Wide Back with Legs	S-XL	6.1	2 D Rings	Leg	MRS	110
Weaver WLC-100 Fixed 2D Float Seat No Legs	S-XL	3.8	2 D Rings	Strap	MRS	110
Climb Right Classic High Back Saddle	S-XL	4.8	2 D Rings	Strap	MRS	111
Edelrid TreeCore <sup>F</sup>	S-XL	4	Webbing/SRS Loop	Leg	SRS, MRS	111
Edelrid TreeRex <sup>F</sup>	S-M, X-XL	5	Double Bridge Rope/ SRS Loop	Leg	SRS, MRS	111
New Tribe ONYX	1, 2	4.4	Rope Bridge	Leg	SRS, MRS	113
Edelrid Fraggie Kids Harness	XXS, XS	2	Full Body	Full Body	SRS, MRS	124
New Tribe Twist Kids Harness	19-32"	1.6	Webbing/SRS Loop Triangle	Leg	SRS, MRS	114

\*SRS (Stationary Rope System); MRS (Moving Rope System); <sup>F</sup> Offers Fall Arrest option; <sup>W</sup> Offers Wide Back Support

## GENERAL HARNESS SIZING

SADDLE SIZE	WAIST (IN   CM)	LEGS (IN   CM)
Small	27-30"   69-76 cm	19-21"   48-53 cm
Medium	30-33"   76-84 cm	21-23"   53-58 cm
Large	33-36"   84-91 cm	23-25"   58-63 cm
Extra Large	36-39"   91-99 cm	25-27"   63-69 cm

Sizing from Black Diamond Equipment

## GENERAL SAFETY GUIDELINES

- Know and follow ANSI Z-133.1.2017 regulations
- Saddle/belt d-rings and attachment points are designed for work positioning and suspension use only and are NOT intended for fall arrest
- The use of fall arrest equipment is highly recommended in addition to the use of saddles and belts
- Only attach connecting devices meeting work positioning and suspension standards and regulations to saddle/belt and d-rings/attachment points
- Only work positioning connecting devices should be attached to side d-rings
- Never attach a chainsaw or rigging line to a saddle/belt d-ring or attachment point Positioning and suspension anchor points must support your weight plus any job related load
- Check the maximum load capacity for accessory hooks and rings
- Arborists shall be tied in/secured while ascending the tree and remain tied/secured until the work is completed and they have returned to the ground
- Arborists shall use a second point attachment, such as a work positioning lanyard or double crotched rope, when operating a chainsaw in a tree

## HARNESS INSPECTION

The condition of your climbing harness is critical to your safety in the tree. Refer to the manufacturer instructions for full inspection guidelines. This list is a good place to start.

### Daily

- Inspect rope bridges
- Inspect all stitching, structural, secondary, and decorative
- Inspect webbing bridges for cuts, abrasions, or damaged stitching
- Inspect hardware and attachment points

### Monthly

- Inspect terminal connection points & bridges
- Inspect hard connections for corrosion or deformation
- Inspect webbing where it is attached to other webbing or turns on hardware
- Inspect all webbing; Qualify all cuts and frays as hazard unless deemed otherwise
- Check for discoloration on hardware that may indicate impact or exposure to unknown substances
- Inspect all gear loops for wear and hardware on those loops for proper functioning
- Make sure that buckles and hardware engage and disengage properly
- Document your monthly gear inspections for reference



# positioning

## CAMP Tree Access EVO

### SPECS + FEATURES

- Mobile bridge system is manufactured from 10.5 mm semi-static rope covered with tubular webbing for the best durability. Two loops on the ends of the bridge create extra points for positioning.
- The adjustable connections to the waist belt allow the user to fine-tune the height of the bridge in order to optimize the position while hanging.
- Waist belt and leg loops are made of ergonomic padding to offer broad structural support and are connected by optimally spaced connection straps.
- STS automatic buckles on the leg loops.
- Ventral attachment features two loops: upper loop is for attaching a chest harness and chest ascender and lower loop for attaching lanyards and rope tools.
- 2 aluminum alloy side attachment points for positioning and restraint.
- Designed for use in combination with the GT Chest, with front and back connection points, to make a full body fall arrest harness.
- Weight: Size 1: 1960 g, 69.2 oz (4.31 lbs); Size 2: 2030 g, 71.7 oz (4.43 lbs)
- Size 1: S-L Waist: 80-120 cm Legs: 50-65 cm
- Size 2: L-XXL Waist: 90-140 cm Legs: 60-75 cm
- Standard(s): EN 358 – EN 813 – ANSI Z133

SKU	SIZE	PRODUCT
216301 S-L	1	Tree Access EVO
216302 L-XXL	2	Tree Access EVO
216403	1	Tree Access EVO Rep. Bridge S-L Waist: 32 cm
216404	2	Tree Access EVO Rep. Bridge L-XXL Waist: 37 cm



216403, 216404

### OPTIONAL FALL ARREST HARNESS



## CAMP GT Chest Harness



### SPECS + FEATURES

- HMS Belay Lock connector that features an anti-rotation system for a secure attachment to the sit harness.
- 2 attachment points: 1 front, 1 back via aluminum alloy attachment rings.
- Designed to be used in combination with the GT Sit, Access Sit, and Tree Access harnesses for fall arrest.
- Size: 1 / S-L Torso Length: 55-75 cm (21.6 - 29.5"); Weight: 550 g (1.2 lbs)
- Certifications: EN 361

SKU	SIZE	PRODUCT
21660101	S-L	GT Chest Harness



## CAMP Tree Access Swing Seat



### SPECS + FEATURES

- A lightweight, rigid aluminum alloy seat with plush padding for prolonged work.
- Designed to integrate seamlessly with the Access Sit, Tree Access EVO, GT Sit, GT ANSI, GT Turbo harnesses using the proprietary Sicura buckles.
- Can also be connected to any EN 813 harness.
- Equipped with buckle for connection to back of harnesses when not in use.
- Weight: 1400 g | 49.4 oz

SKU	SIZE	PRODUCT
1963	-	Tree Access Swing Seat



## Teufelberger treeMOTION EVO Harness



### SPECS + FEATURES

- Freedom of movement and ergonomic comfort
- Adjustable load distribution between leg and back support
- Reduced pressure points due to multi layer webbing layout
- Color coded attachment hardware for improved safety
- Multiple options for approved/certified bridge hardware
- Replaceable, washable back padding
- Flexible and highly supportive back frame
- Gear brackets compatible with a range of tool carrying hardware
- Customizable gear loops
- Gear brackets on leg loops
- Rings 22"
- One Size - Waist 30-36"; Legs 26-33"

SKU	SIZE	PRODUCT
7350156	-	treeMOTION EVO Harness



## Teufelberger treeMOTION Super Light



Teufelberger's treeMOTION Super Light is a stripped down, super-light, lower-cost version of the regular treeMOTION. Weight is only 1800 grams!

### SPECS + FEATURES

- Removable and washable padding
- Thinner back padding similar to 1st generation treeMOTION
- Lightweight low profile slide buckles on the waist and leg
- Easy adjustable bridge
- 6 Caritool positions including on leg straps, & over 100 other position possibilities
- 2 heavy duty and vertically adjustable cord loops
- First aid kit position with two cinch straps in the lumbar area
- Load bearing chainsaw ring
- Double D-rings to disperse the weight
- Rated lower D rings
- One Size - Waist 30-38"; Legs 26-33"
- Certified Standards: EN 358/813, ANSI Z133-2012

SKU	SIZE	PRODUCT
7350139	-	treeMOTION S. Light



## Teufelberger treeMOTION Hip to Leg Connection Kit

Teufelberger replacement hip/leg connector for treeMOTION climbing harness. This is a wear part and should be included in your daily gear inspection checklist.

### SPECS + FEATURES

- Hip to Leg Connection Kit Replacement webbing strap simply girth-hitches in place after removal of worn out straps.
- Includes: 2 x Webbing straps; 4 x Pair of plastic rivets; 2 x Elastic loops; 1 x Instruction manual

SKU	SIZE	PRODUCT
7333208	-	treeMOTION Hip to Leg Connection Kit





### Teufelberger treeMOTION Back Pad



**SPECS + FEATURES**

- Fits without creating folds, designed to give extra support to the lower back
- Features wide flexible grooves that support the dissipation of heat
- Designed for the lumbar region and provides additional support in that zone
- 12" W x 2" H x 2" D

SKU	SIZE	PRODUCT
7359960	-	treeMOTION Replacement Back Pad



LUMBAR SUPPORT BACK PADDING

### Teufelberger treeMOTION Leg Pads



**SPECS + FEATURES**

- These leg padding are a direct replacement for the original leg loop padding.
- Includes 2 pads

SKU	SIZE	PRODUCT
7333209	-	treeMOTION Replacement Leg Pads



### Teufelberger treeMOTION Standard or Super Light Replacement Bridge



**SPECS + FEATURES**

- Field replaceable, genuine original spare part for treeMOTION harness.
- Stitched 'tail' seam, factory knotted and stitched at one end
- Robust polyester sheath
- Suits use with DMM Swivels
- The stopper knots must be able to stand a 2 kN (200kg) force and the knot tail length should be 5-times the diameter of the rope bridge.

SKU	SIZE	PRODUCT
7333212	-	treeMOTION Replacement Bridge



FACTORY KNOTTED & STITCHED AT ONE END

### Teufelberger treeMOTION Leg Loop Strap



**SPECS + FEATURES**

- Spare parts for treeMOTION Standard and treeMOTION EVO.
- Includes: 1 Instruction booklet; 2 Lengths of the rubber connection; 1 Elastic loop, 6 rivets
- Does not come with the padding

IMPORTANT INFORMATION - The leg loops may be replaced only on harnesses where the technical label is attached to the waist belt. This will be the case on all models produced in June 2009 and later. If you own a later model, it is imperative that you send your harness to the manufacturer for repair.

SKU	SIZE	PRODUCT
7333206	Right	treeMOTION Replacement Leg Loop Strap
7333207	Left	treeMOTION Replacement Leg Loop Strap



### Teufelberger treeMOTION Shoulder Strap



Some climbers simply prefer to work with a shoulder system. Others like the ability to add a load carrying upper harness during tree removal operations. Another variation is to use shoulder straps to suspend a chest mounted rope clamp during ascent.

**SPECS + FEATURES**

- Two part system that can be configured how you want, depending on the demands of the work ahead of you.
- treeMOTION harness is for work positioning applications only.
- Suitable for both treeMOTION and treeMOTION EVO harness.

NOTE - WARNING: This Upper Assembly is NOT for use in PPE personal protective equipment) systems.

SKU	SIZE	PRODUCT
7333211	-	treeMOTION Shoulder Strap



## BUCK Agility™ Saddle NEW



The **BUCK Agility Saddle** was designed in conjunction with Jamie Chambrelli, and the team at ArborMaster™ Training Inc. The **Agility Saddle**, handmade in the USA, was designed and built for "Work" with a focus on comfort, durability, mobility, and functionality.

### SPECS + FEATURES

- Hook & Loop "stay put" waist and leg straps for easy one-time adjustment.
- Articulating legs pads and straps engineered to give you maximized mobility.
- Segmented rope bridge for added attachment options/length adjustments.
- Features options for a multi-bridge setup and a forward lower D-Ring setup.
- Specialized back pad allows for max coverage without getting into your ribs and supports your back in problem areas, where a lot of climber back injuries occur.
- Large leg pads for more support and extra comfort around your legs.
- Independent leg suspension straps adjusting leg shape and size.
- Gear loops that are easier to reach and to place hardware on.
- 4 spots for tool hangers and various loops for racking smaller gear like ascenders.

SKU	SIZE	PRODUCT
1480S	S	Agility
1480M	M	Agility
1480L	L	Agility
1480XL	XL	Agility



## BUCK Ergovation™ Saddle



Fully customized waist tensioner and lumbar support gives user improved fit, abdominal stability, and promotes optimal posture when climbing.

### SPECS + FEATURES

- ERGOVATION saddle has 7 different rated attachment points.
- Fully modular design for a customized fit.
- 6 accessory loops.
- Comfort with fully padded Drilex back pad to contour the pelvis and support lower back
- Closed cell padding can be removed for washing, which improves hygiene
- Load distributing design decreases pressure on pelvis
- Increased padding in pelvis and hip regions for added comfort

SKU	SIZE	PRODUCT
16906S	S	Ergovation
16906M	M	Ergovation
16906L	L	Ergovation
16906XL	XL	Ergovation

SEE SIZING CHART ON NEXT PAGE



Full support with elastic cummerbund waist support & highly adjustable

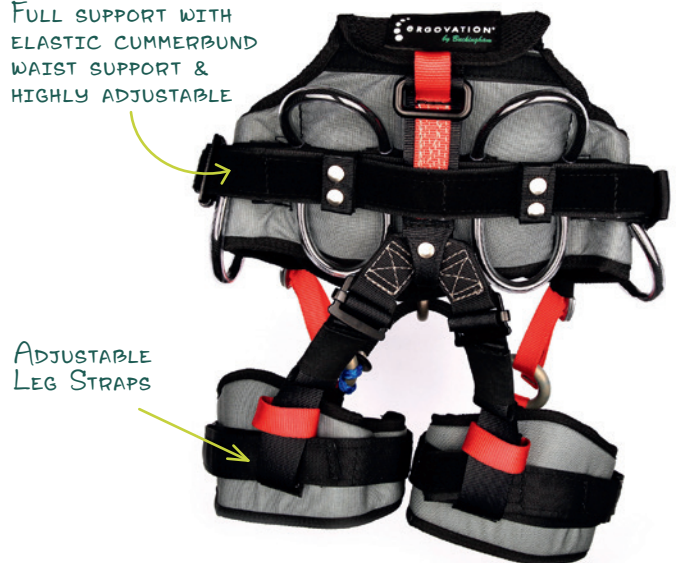





### BUCK 1371 Improved Economy Saddle

An economy saddle that has all the benefits of the original economy saddles but with improvements to comfort and functionality.

**SPECS + FEATURES**

- Five accessory loops to stow gear while working aloft
- Piggy back snaps and ring assembly keeps tools accessible
- Four small D rings are available for suspender attachments
- Has a wide padded leather lined back that provides superior comfort and support from the 5 1/2" wide back support constructed with rubberized belting material.

SKU	SIZE	PRODUCT
1371S	S	1371 Improved Economy Saddle
1371M	M	1371 Improved Economy Saddle
1371L	L	1371 Improved Economy Saddle
1371XL	XL	1371 Improved Economy Saddle



**BUCK HARNESS SIZING**

SADDLE SIZE	WAIST	LEGS	SADDLE SIZE	WAIST	LEGS
Small	28-32"	23-32"	Large	36-40"	25-37"
Medium	32-36"	24-35"	Extra Large	40-44"	26-39"



**BUCK TREE**  
BUCKINGHAM MFG



## Weaver Cougar WLC-700 Saddle with Leg Straps featuring Memory Foam Pads



High-end styling combines comfortable leg straps with an easy-to-inspect sewn webbing suspension bridge for a saddle that meets all the demands of an arborist.

### SPECS + FEATURES

- Suspension bridge has a striped white and dark orange Spectra fiber overlay for strength and abrasion resistance that surrounds a black nylon tubular webbing core to provide for additional wear inspection.
- Enhanced extra wide back pad extends further forward on hips.
- The 4" wide leg pads and extra wide 7" back are constructed from memory foam that conforms to the back, reduces pressure points, wicks away moisture and does not retain heat for cool, comfortable performance.
- Leg straps and straps attached to bridge are adjustable
- Replaceable sewn webbing suspension bridge features two rubber bumpers and can be used with forged aluminum rings.
- Buckle at waist features a roller for ease of use and to reduce wear to waist belt.
- 2 nylon utility straps with a chrome brass 200 snap and a 2" nickel plated ring keep tools close at hand.

Important: Not to be used for fall arrest. Only authorized replacement parts from Weaver Arborist should be used on this saddle. The use of unauthorized replacement parts will void Weaver Arborist's Warranty.

SKU	SIZE	PRODUCT
0801085XS	XS	Cougar WLC-700 Saddle
0801085SM	S	Cougar WLC-700 Saddle
0801085MD	M	Cougar WLC-700 Saddle
0801085LG	L	Cougar WLC-700 Saddle
0801085XL	XL	Cougar WLC-700 Saddle
0898135	-	Cougar WLC-700 Replacement Bridge



REPLACEMENT BRIDGE

### WEAVER HARNESS SIZING

SADDLE SIZE	D-TO-D	APPROX WAIST	SADDLE SIZE	D-TO-D	APPROX WAIST
Extra Small	18"	26" to 34"	Large	24"	36" to 44"
Small	20"	30" to 38"	Extra Large	26"	40" to 48"
Medium	22"	32" to 40"			

## Weaver Cougar Replacement Leg Pads



Sizing: S, M, L (fit to your corresponding harness size)

SKU	SIZE	PRODUCT
0898126S	S	Cougar WLC-700 Replacement Leg Pads
0898126M	M	Cougar WLC-700 Replacement Leg Pads
0898126L	L	Cougar WLC-700 Replacement Leg Pads



## Weaver Cougar Replacement Batten Seat



### SPECS + FEATURES

- 4" wide and reinforced with an aluminum bar covered in foam that provides extra support
- Adjustable straps keep the seat ideally positioned
- Ideal for arborists who are in the saddle for long periods of time
- Fits the WLC-700 and WLC-730 saddles (formerly called Cougar saddles), and the new WLC-760 and WLC-790 saddles
- Sizes: Medium, Large (40" - 44") - Fits to your corresponding harness size
- Weight: 1 lb

SKU	SIZE	PRODUCT
0898128MD	M	Cougar Replacement Batten Seat
0898128LG	L	Cougar Replacement Batten Seat







## Weaver Denali Harness

The **Denali** combines patented AirFlex technology and high-performing safety features for the ultimate climbing experience. Double rope suspension bridge on this arborist saddle features a diamond knot at one end and a girth hitch on the other for replicability and security. The rope that constructs the double rope suspension bridge offers the perfect combination of durability and function. The white core within the black and orange suspension bridge makes wear and tear visible at a glance, allowing for additional wear inspection. Extra wide back pad extends further forward on hips for enhanced comfort and support. Handcrafted in the USA by the finest craftspeople who care about every last detail.

Important: Climbing harness is not intended to be used for fall arrest. Only authorized replacement parts from Weaver Arborist should be used on this arborist saddle. The use of unauthorized replacement parts will void Weaver Arborist's warranty.

### SPECS + FEATURES

- Adjustable waist (28"-48")
- Adjustable position hip D-rings and leg pads
- Lightweight, high-strength aluminum hip D-rings and rigging plates
- Rugged, durable water buffalo leather forms to the shape of your body
- Double rope suspension bridge on this arborist saddle features a diamond knot at one end and a girth hitch on the other for replicability and security.
- Replaceable back pads, leg pads and bridge.
- High-strength nylon webbing with multiple gear loops for easy, personalized configuration.
- Weighs 6.5 lbs.



SKU	SIZE	PRODUCT
08-01100-A1	ALL	Denali Harness

## Weaver Cougar WLC-730 Harness

### SPECS + FEATURES

- Suspension bridge has a striped white and dark orange Spectra fiber overlay for strength and abrasion resistance that surrounds a black nylon tubular webbing core to provide for additional wear inspection.
- The 4" wide batten seat is reinforced with an aluminum bar covered in foam that provides extra support.
- Enhanced extra wide back pad extends further forward on hips
- The extra wide 7" back is constructed from two layers of memory foam that conform to the back, reduce pressure points, wick away moisture and do not retain heat for cool, comfortable performance.
- Batten seat and suspension bridge are replaceable.
- Adjustable accessory batten seat straps keep your batten seat positioned for optimum comfort.
- Replaceable sewn webbing suspension bridge features two rubber bumpers and can be used with forged aluminum rings.
- Buckle at waist features a roller for ease of use and to reduce wear to waist belt.
- 2 nylon utility straps with a chrome brass 200 snap and a 2" nickel plated ring keep tools close at hand.
- D-rings at front and back offer easy attachment of suspenders (sold separately).

Important: Not to be used for fall arrest. Only authorized replacement parts from Weaver Arborist should be used on this saddle. The use of unauthorized replacement parts will void Weaver Arborist's Warranty.



SKU	SIZE	PRODUCT
08-01086 XS	XS	Cougar WLC-730 Web Bridge w/ batten
0801086SM	S	Cougar WLC-730 Web Bridge w/ batten
0801086MD	M	Cougar WLC-730 Web Bridge w/ batten
0801086LG	L	Cougar WLC-730 Web Bridge w/ batten
0801086XL	XL	Cougar WLC-730 Web Bridge w/ batten

## Weaver WLC-300 Harness

### SPECS + FEATURES

- Nylon leg straps and extra wide back provide optimum comfort
- D-rings made from forged aluminum with a black anodized finish.
- Fixed position, angled side D-rings feature a two bar design and offer easy access; you can snap in with just one hand!
- Saddle back features two rounded nylon loops that are covered with clear rubber tubes that help resist excess wear.
- Two additional D-rings located on the bottom of the waist back for attachment of one of our ditty bag options or a first aid kit. Extra wide 6" waist back is foam filled and lined with soft oil tanned top grain steer hide leather.
- Features a loop for holding carabiners and 2 nylon utility straps with a chrome brass 200 snap and a 2" nickel plated ring to keep tools handy.
- Seat strap and leg straps are also lined with soft oil tanned top grain steer hide leather.
- Accessory loop weight capacity: 15 lbs

Important: Not to be used for fall arrest. Only authorized replacement parts from Weaver Arborist should be used on this saddle. The use of unauthorized replacement parts will void Weaver Arborist's Warranty.

SKU	SIZE	PRODUCT
0801033S	S	WLC-300 Double D Wide Back
0801033M	M	WLC-300 Double D Wide Back
0801033L	L	WLC-300 Double D Wide Back
0801033XL	XL	WLC-300 Double D Wide Back

### WEAVER HARNESS SIZING

SADDLE SIZE	D-TO-D	APPROX WAIST	SADDLE SIZE	D-TO-D	APPROX WAIST
Small	20"	30" to 38"	Large	24"	36" to 44"
Medium	22"	32" to 40"	Extra Large	26"	40" to 48"



## Weaver WLC-330 Saddle

Offers freedom of movement with one Floating D-ring and 2" Nylon Leg Straps

### SPECS + FEATURES

- Floating D-rings provide easy maneuverability.
- D-rings are made from forged aluminum with a black anodized finish.
- Fixed position, angled side D-rings feature a two bar design and offer easy access. Saddle backs feature 2 rounded nylon loops that are covered with clear rubber tubes that help resist excess wear. Each loop will hold up to 15 lbs. of accessories.
- 2 additional D-rings located on the bottom of the waist back for attachment of one of our ditty bag options or a first aid kit.
- Front strap is reinforced with neoprene for extra durability.
- Extra wide 6" waist back is foam filled and lined with soft oil tanned top grain steer hide leather.
- Features a loop for holding carabiners and 2 nylon utility straps with a chrome brass 200 snap and a 2" nickel plated ring to keep tools close at hand.
- The 2" wide nylon leg straps are lined with soft oil tanned top grain steer hide leather for extra comfort.
- Features D-rings at front and back for attachment of suspenders (sold separately).

Important: Not to be used for fall arrest. Only authorized replacement parts from Weaver Arborist should be used on this saddle. The use of unauthorized replacement parts will void Weaver Arborist's Warranty.

SKU	SIZE	PRODUCT
0801040S	S	WLC-330 Floating D Wide Back
0801040M	M	WLC-330 Floating D Wide Back
0801040L	L	WLC-330 Floating D Wide Back







## Weaver WLC-390 Saddle with Batten Seat

With a comfortable, extra wide back and a batten seat

### SPECS + FEATURES

- D-rings are made from forged aluminum with black anodized finish.
- Fixed position, angled side D-rings feature a two bar design and offer easy access
- Saddle back features 2 rounded nylon loops that are covered with clear rubber tubes that help resist excess wear. Each loop will hold up to 15 lbs. of accessories.
- Leg straps help prevent slip-through and are made from heavy-duty coated webbing that is pre-cut, pre-punched and heat-sealed to prevent fraying.
- 2 additional D-rings are located on the bottom of the waist back for attachment of one of our ditty bag options or a first aid kit.
- The 4" wide batten seat is reinforced with an aluminum bar covered in foam that provides extra support.
- The 6" wide waist back is foam filled and lined with soft oil tanned top grain steer hide leather.
- Batten seat floats on waist belt for easy positioning and comfort.
- Features adjustable accessory batten seat straps that keep your batten seat properly positioned.
- Features a loop for holding carabiners and 2 nylon utility straps with a chrome brass 200 snap and a 2" nickel plated ring to keep tools handy.

Important: Not to be used for fall arrest. Only authorized replacement parts from Weaver Arborist should be used on this saddle. The use of unauthorized replacement parts will void Weaver Arborist's Warranty.

SKU	SIZE	PRODUCT
0801078S	S	WLC-390 Double D Wide Back w/Batten
0801078M	M	WLC-390 Double D Wide Back w/Batten
0801078L	L	WLC-390 Double D Wide Back w/Batten
0801078XL	XL	WLC-390 Double D Wide Back w/Batten

SEE SIZING CHART ON PREVIOUS PAGE



## Weaver WLC-500 Saddle with Padded Nylon Leg Straps

Padded nylon leg straps and extra wide back make this saddle a comfortable choice.

### SPECS + FEATURES

- D-rings are made from forged aluminum with a black anodized finish.
- Fixed position, angled side D-rings feature a 2 bar design and offer easy access
- Saddle back features 2 rounded nylon loops that are covered with clear rubber tubes that help resist excess wear. Each loop will hold up to 15 lbs.
- 2 additional D-rings located on the bottom of the waist back for attachment of one of our ditty bag options or a first aid kit.
- An extra wide 6" waist back provides cushioning and back support.
- Waist back is foam filled and lined with soft oil tanned top grain steer hide leather.
- Adjustable accessory leg straps keep your padded leg straps positioned for optimum comfort.
- Features a loop for holding carabiners and 2 nylon utility straps with a chrome brass 200 snap and a 2" nickel plated ring to keep tools handy.
- Slip-on, foam filled, leather lined pads give the 2" nylon leg straps extra comfort.

Important: Not to be used for fall arrest. Only authorized replacement parts from Weaver Arborist should be used on this saddle. The use of unauthorized replacement parts will void Weaver Arborist's Warranty.

SKU	SIZE	PRODUCT
0801032S	S	WLC-500 Double D Wide Back with Legs
0801032M	M	WLC-500 Double D Wide Back with Legs
0801032L	L	WLC-500 Double D Wide Back with Legs
0801032XL	XL	WLC-500 Double D Wide Back with Legs

SEE SIZING CHART ON PREVIOUS PAGE



## Weaver WLC-130 Saddle with Heavy-Duty Coated Webbing Leg Straps



### SPECS + FEATURES

- Four D-rings offer more positioning options and help add more stability
- D-rings are made from forged aluminum with black anodized finish
- Fixed position, angled side D-rings feature a two bar design and offer easy access
- Saddle back features 2 rounded nylon loops that are covered with clear rubber tubes that help resist excess wear. Each loop will hold up to 15 lbs. of accessories.
- Two additional D-rings located on the bottom of the waist back for attachment of one of our ditty bag options or a first aid kit.
- Heavy-duty coated webbing leg straps help prevent slip through and are pre-cut, pre-punched and heat-sealed
- Features a loop for holding carabiners and two nylon utility straps WITH a stainless steel 200 snap and a 2" plated ring to keep tools handy.
- Floating seat strap can easily be positioned for maximum comfort.
- Leg straps are lock-stitched and riveted to seat strap.

Important: Not to be used for fall arrest. Only authorized replacement parts from Weaver Arborist should be used on this saddle. The use of unauthorized replacement parts will void Weaver Arborist's Warranty.

SKU	SIZE	PRODUCT
0801010SM	S	WLC-130 with Heavy-Duty Webbing Leg Straps
0801010MD	M	WLC-130 with Heavy-Duty Webbing Leg Straps
0801010LG	L	WLC-130 with Heavy-Duty Webbing Leg Straps
0801010XL	XL	WLC-130 with Heavy-Duty Webbing Leg Straps



## Weaver WLC-100 Saddle without Leg Straps



A simple choice, and basic harness with a popular four d-ring design

### SPECS + FEATURES

- D-rings are made from forged aluminum with black anodized finish
- Fixed position, angled side D-rings feature a two bar design and offer easy access
- Two additional D-rings located on the bottom of the waist back for attachment of one of our ditty bag options or a first aid kit.
- Cotton webbing reinforced with nylon provides comfort and strength.
- Floating seat strap can easily be positioned for maximum comfort.
- Features a loop for holding carabiners and two nylon utility straps with a chrome brass 200 snap and a 2" nickel plated ring to keep tools handy.

Important: Not to be used for fall arrest. Only authorized replacement parts from Weaver Arborist should be used on this saddle. The use of unauthorized replacement parts will void Weaver Arborist's Warranty.

SKU	SIZE	PRODUCT
0801005SM	S	WLC-100 Saddle without Leg Straps
0801005MD	M	WLC-100 Saddle without Leg Straps
0801005LG	L	WLC-100 Saddle without Leg Straps
0801005XL	XL	WLC-100 Saddle without Leg Straps



SEE SIZING CHART ON PREVIOUS PAGE

## Weaver Harness Suspending



Elastic, Heavy-duty Harness Suspending.

SKU	SIZE	PRODUCT
0898122	-	Harness Suspending





## Spyder Climb Right Classic High Back Saddle

This **Spyder Classic Harness** from **Climb Right** has a wide back pad that is layered for comfort and support.

### SPECS + FEATURES

- Tongue style waist belt
- Soft batten seat with legs straps
- 2-D Ring Style Bridge – great simple harness for closed traditional system
- Economical harness
- 2 Hip D Rings for Lanyard
- Made in USA

SKU	SIZE	PRODUCT
83046	S	Climb Right High Back Saddle
83047	M	Climb Right High Back Saddle
83048	L	Climb Right High Back Saddle
83049	XL	Climb Right High Back Saddle

2D



## Edelrid TreeCore Harness

### SPECS + FEATURES

- The modular belt system comprises removable D-rings, comfortable padding and sliding D-System to guarantee optimum work positioning and easy adjustment of the waist support.
- For secure and efficient equipment management the TreeCore has four gear loops, two buckle straps and slide buckle loops, e.g. for chainsaw attachment.
- Easily-adjustable leg loops ensure optimum wear comfort and make the belt easier to put on and take off.
- The TreeCore can also be combined with Edelrid's TreeCore Top chest harness to make it fully compatible to use in a bucket truck (aerial lift)
- Color: Oasis
- Weight: 1250g
- Replaceable bridge: yes
- Waist Diameter: 71-131 cm | 27" - 52"; Thigh Diameter: 40-80 cm | 15.5" - 31.5"
- CE Certified
- Certifications: EN 361EN 358EN 813EN 1497EN 1498EN 12277ANSI Z133-2017

SKU	SIZE	PRODUCT
880360232190	S-XL	TreeCore
880730000170	-	TreeCore Replacement Bridge

EDELRID



1D

REPLACEMENT  
BRIDGE



## Edelrid Core Top Harness

The **Core Top** is a very comfortable chest harness which can be added to the **TreeCore harness** to transform it into a full body fall-protection harness (EN 361) to provide the required safety and stability for work at height.

The **Core Top** is a very comfortable chest harness, becoming a fall arrest harness in accordance with EN 361 when combined with the **TreeCore**.

### SPECS + FEATURES

- Padded shoulder straps and aids support of the weight belt when chainsaw is attached
- Can be fitted with a tether to tend hybrid SRT/WP devices
- Two Easy Glider buckles – easily adjusted for different-sized operators/climbers

SKU	COLOR	PRODUCT
880410230170	Night	TreeCore Top

EDELRID



880410232190



880410230170

## Edelrid TreeRex Harness

The most versatile tree-care harness of all times.

### SPECS + FEATURES

- Increase comfort because of Innovative 3D Vent Technology
- Wide, semi-rigid padding
- Bridge lateral fasteners can be adjusted with ease to change the sit or hang position.
- Number gear attachment possibilities
- 4 large gear loops
- Device for suspending a chainsaw
- TreeRex comes to you ready to work.
- Color coded rope bridges
- An adjustable rope bridge is supplied in the lateral eyelets with aluminum connecting ring
- Great safety features: Bridges red core wear indicator tracers and Integrated RFID chip
- Optional SRT BRIDGE specifically designed to work safely and comfortably while on single line.
- Weight: 5 lbs

SKU	SIZE	PRODUCT
887020152190	1 S-M	TreeRex
887020142190	2 L-XL	TreeRex

3 BRIDGE OPTIONS;  
LIGHTWEIGHT BUT  
LOTS OF SUPPORT!



## TREEREX TRIPLE LOCK

Versatile Tree Climbing Harness

Up to 3 rope bridge configurations and optional removeable SRT bridge for working on Stationary Rope Systems

3D Vent Technology for unbeatable fit, comfort and breathability

Triple Lock buckles on waist belt and leg loops allow it to be easily put on and taken off

Multiple gear loops and 2 attachment points designed specifically to accommodate screw on tool holders

Compatible with bosun's chair and ANSI Z133-2017 certification

Scan & Learn



CREATIVE TECHNOLOGY.







## New Tribe ONYX ROPE BRIDGE Arborist Saddle

**ONYX** is the black beauty of professional tree saddles. It is made to move with ease anywhere your rope can take you. It is structure, not bulky padding, that delivers the superior comfort that **New Tribe** saddles are famous for. **ONYX** is compact yet clever, fitted with rings, loops and slots for the tools of the trade. The triangle leg pad offers a totally different fit than most harnesses; the design alleviates pressure on your sciatica nerve and reduces strain around your back and kidneys because more of your weight is support between your legs and the waist belt. And it's versatile, you can swap out the rope bridge for a Webbing Bridge Conversion Kit (sold separately).

### SPECS + FEATURES

- Adjustable belt size and leg loop size – structured belt pad and leg pads for surprising comfort with lowest weight and bulk
- Bridge is replaceable, kit includes: 2 - SMC aluminum rigging plates and 4' - Yale Bandit 11mm
- 4 gear loops and 1 large gear loop at back (removable)
- 4 tool slots, 2 large tool loops
- 4 carabiner loops
- 1 rear rescue loop
- 3 aluminum rings and 2 accessory rings for optional suspenders
- Size 1 – Waist 26-37"; Rings 26"; Legs 25-37"
- Size 2 – Waist 33-46"; Rings 29"; Legs 25-42"
- Weight: 4 lbs 13 oz

SKU	SIZE	PRODUCT
19210	1	ONYX Rope Bridge
19410	2	ONYX Rope Bridge
29110	-	ONYX Replacement Bridge kit



ADJUST LENGTH TO YOUR PREFERENCE



## New Tribe Harness Optional Leg Pads



### SPECS + FEATURES

- Contoured to match the shape of the fabric leg panels.
- Made to attach to the inside of the leg pad with Velcro attachment
- Alleviates the fabric from collapsing around your thigh
- Offered as add on because some people want less weight

SKU	SIZE	PRODUCT
29112	-	ONYX Leg Pads

ADD COMFORT & SUPPORT FOR YOUR LEGS STRAPS FOR YOUR ONYX



## New Tribe Pro Suspender



This is a single **suspender** for use with **New Tribe's** professional saddles. Worn across your chest like a bandoleer, this suspender will stay on your shoulder. It's so close-fitting it never gets in your way.

### SPECS + FEATURES

- The strap length can be adjusted at both ends, so you can position the shoulder pad where you want it and it will stay there.
- One is enough if you hang heavy gear like your chainsaw on only one side of your belt.
- Two suspenders work together, one over each shoulder, when you want comfortable support for both sides of the belt.
- Weight: 4 oz.

SKU	COLOR	PRODUCT
29100	Black	Pro Suspender



## TreeHog TH5000 Razorback Leg Harness



The **TreeHog TH5000 Razorback** is a comfortable and robust tree climbing harness at an affordable price. The length of the webbing attaching the bridge to the harness can be altered to adjust center of gravity, and different length bridges are also available for further customization. With a variety of gear loops and tool attachment points, the **TH5000** harness has everything that you need in an arborist harness.

### SPECS + FEATURES

- Individual leg loops and comes equipped with quick release leg and waist buckles
- Wide back pad
- 2 side attachment points for flip line (or lanyard)
- Webbing bridge
- Complies with EN358 & EN813.
- Waist size: S: 66-7 cm (26" - 30"); M/L: 76-96 cm (30" - 38"); XL/XXL: >96 cm (38"+) (Call to special order)



SKU	SIZE	PRODUCT
AB324700 (TH5000)	S	TH5000 Razorback Leg Harness
AB324701 (TH5000)	M-L	TH5000 Razorback Leg Harness

## TreeHog TH7000 Razorback Batten Seat Harness



The **TreeHog TH7000 Razorback Batten Seat Harness** is a tree climbing sit harness with a fixed swinging seat (i.e. not separate leg loops). The seat is reinforced to ensure comfort for long days in the tree.

### SPECS + FEATURES

- Quick release waist and leg buckles
- Double sliding rings on replaceable/adjustable bridge
- 2 side attachment points for flip line
- 3 large gear loops
- Extra attachment points for tool holders
- Individually serial numbered for inspection/tracking
- Complies with EN358 & EN813:2008
- Waist size: S: 66-7 cm (26" - 30"); M/L: 76-96 cm (30" - 38"); XL/XXL: >96 cm (38"+) (Call to special order)



SKU	SIZE	PRODUCT
AB324703 (TH7000)	S	TH7000 Razorback Batten Seat Harness
AB324704 (TH7000)	M-L	TH7000 Razorback Batten Seat Harness

## New Tribe Twist - Kids Harness



At first glance this looks harness looks like the **New Tribe's** Basic Harness that has been a signature design for almost thirty years. It has all the same benefits as the old Basic and more.

### SPECS + FEATURES

- So, what's the twist? The ease of size adjustability from waist size 19" to 32"
- Hefty pads on belt and leg loops
- Special features for carrying gear such as additional climbing tools, water bottle, snack, gloves, or camera: 1 snap hook, 2 carabiner loops, 1 aluminum accessory ring, 2 slots on the belt for gear bags and carabiners
- Made with wide 1-3/4" nylon parachute webbing rated at 6,000 lbs
- Tie-in point bright red
- Steel adjuster buckles
- Adjustable leg loops fit small to large
- Turned back ends keep webbing from slipping out of the buckles accidentally



SKU	SIZE	PRODUCT
28000	19" to 32"	Twist - Kids Harness



# accessories

## ISC Anchor Aluminum Rings



### SPECS + FEATURES

- Lightweight but strong
- Small & Large MBS: 25 kN | 5620 lbs
- Large Ring OD: 2.65", ID: 1.8"; Small Ring ID: 1.1"; Stock diameter: 12mm

SKU	ATTRIBUTE	PRODUCT
RIN0010A	SM	ISC Alum Ring
RIN0011A	LG	ISC Alum Ring



RINGS ARE GREAT FOR HARNESS  
BRIDGE CONNECTORS; OR TO ADD  
TO YOUR SPLICING PROJECTS

## ISC Steel Ring



### SPECS + FEATURES

- Small Steel Ring Diameter: Internal 27mm (1 1/8"); Outside 51mm (2")
- Large Steel Ring Diameter: Internal 45mm (1 3/4"); Outside 70mm (2 3/4")
- MBS: 70kN (15736 lbf)

SKU	ATTRIBUTE	PRODUCT
RIN0012A	SM	ISC Steel Ring
RIN0013A	LG	ISC Steel Ring



FOR ADDITIONAL RIGGING RINGS, VISIT PAGE 227

## DMM Anchor Rings



Perfect for lifelines, rescue, stretcher management, tree care, etc. Rings connect beautifully with DMM Revolver Locksafe connectors to create a swinging captive eye.

### SPECS + FEATURES

- CNC machined from top grade alloy for strength, durability and lightness
- Surface finish facilitates smooth rope operation
- Individually marked for traceability
- CE Certified to EN795(b):1996 (Transportable temporary anchor devices)
- Anodized to BS EN ISO 7599:2010 class 10 E1 sealed for corrosion protection
- Strength: 30 kN; SWL: 6 kN
- Size: 26 mm - Weight: 39 g      Size: 28 mm - Weight: 42 g
- Size: 34 mm - Weight: 49 g      Size: 40 mm - Weight: 51 g

SKU	ATTRIBUTE	PRODUCT
R500-26	26 mm	DMM Anchor Rings
R500-28	28 mm	DMM Anchor Rings
R500-34	34 mm	DMM Anchor Rings
R500-40	40 mm	DMM Anchor Rings



## Bourdon Forge Steel Cable Ring



Great for hub and spoke cabling systems, as well as rigging applications. Also used as friction saver rings to allow for large eye passage or two attached lines.

### SPECS + FEATURES

- Hot Forged Alloy Steel, Zinc Plated, Thermal Treated
- Ultimate Load: 150 kN (33,750 lbs.)
- Approximate weight: 10 oz.

SKU	ATTRIBUTE	PRODUCT
20041G	LARGE	Steel Cable Ring



# harness accessories

HARNESSES / ACCESSORIES / SRS CHEST HARNESSES

## Weaver SRT Chest Harness with Daisy Chain



### SPECS + FEATURES

- Designed to help advance your SRT climbing system as you ascend, this effective chest harness has multiple hook-in loops and an adjustable fit.
- SRT tending harness constructed with 1" nylon webbing
- Four front loops allow you to hook in at various heights
- Works great as an attachment point for the HAAS and most SRT climbing systems
- Durable stainless steel ring for dependability
- Both sides adjust for a perfect fit
- Right-side, quick-release buckle for easy on and off
- Fits up to a 50" chest circumference
- Note: Not for primary life support

SKU	ATTRIBUTE	PRODUCT
08650-00		SRT Chest Harness with Daisy Chain



## Weaver SRT Chest Box

Weaver's SRT Chest Box is comfortable and affordable.



### SPECS + FEATURES

- Lightweight and adjustable, this chest box offers an unencumbering design.
- Constructed from 1" poly and elastic webbing
- Has 1" beveled non-rust stainless center steel D
- Black plastic loop with a quick-release buckle.
- Features 21" shoulder straps and a waist that adjusts from 33"-52"
- Great for SRT and for aerial rescue scenarios"

SKU	ATTRIBUTE	PRODUCT
0898106		SRT Chest Box



## 4SRT Chester Harness

The 4SRT Chester Harness has been designed specifically to aid climbing SRT. The harness offers a great balance of effectiveness and comfort. It will work with the newest SRT and hybrid work positioning devices. This is a minimal, lightweight chest harness with seven webbing loops to tend your climbing device. The DMM XSRE carabiner is recommended but not included.



### SPECS + FEATURES

- 7 webbing loop center connector points
- 1 center ring attachment
- Comfortable for both men and women
- Standard: 36 - 46 inch chest; Large: 46 - 52 inch chest (available by special order)

SKU	ATTRIBUTE	PRODUCT
4SRT-CH-S	Standard	Chester Harness



SO COMFORTABLE, YOU'LL FORGET YOU'RE WEARING IT!

Carabiner not included



## Edelrid TreeRex Bungee Chest Harness



Size-adjustable chest harness for comfortable ascent.

### SPECS + FEATURES

- 3D mesh padding for maximum comfort and improved breathability
- Various attachment loops to secure a guided-type fall arrester
- Adjustable bungee cord for hauling a knee ascender
- Can be directly connected to the waist belt of the TreeRex tree-climbing harness

SKU	ATTRIBUTE	PRODUCT
887120012190		TreeRex Bungee Chest Harness



## Edelrid Agent Chest Harness



Edelrid's Chest Harness improves on a basic figure eight design.

### SPECS + FEATURES

- Figure 8 design
- Fully adjustable
- Adds vertical stability with a harness
- Breathable mesh offers excellent ventilation
- Weight: 200 g | 0.44 lbs
- Sliding closure
- Sizing: Small = chest up to 60"      Large = chest up to 80"

SKU	ATTRIBUTE	PRODUCT
716160050170	Small	Agent Chest Harness
716160070170	Large	Agent Chest Harness



Melissa LaVangie, Certified Arborist, MA

# harness accessories

HARNESSES / ACCESSORIES

## Weaver Chainsaw Bungee Lanyard

Bungee design easily stretches when you're using saw and retracts when hanging close to your saddle or belt. Not intended for breakaway.

### SPECS + FEATURES

- 1-3/16" Nylon webbing; double box-stitched with 1" elastic. Heat-sealed ends help prevent fraying
- Easily attaches to harness rings or snaps
- A half twist in the loop end helps keep equipment hanging straight
- Welded 2" nickel plated rings
- Length: 30" at rest and 45-1/2" long when fully extended
- Non-rust manganese bronze 225 snap is 4-1/4" long.

SKU	ATTRIBUTE	PRODUCT
0898225	snap/ring	Weaver Chainsaw Bungee Lanyard
0898226	ring/ring	Chainsaw Bungee Lanyard



## Weaver Chainsaw Strap with Snap/Ring

Nylon straps with a half twist help keep equipment hanging straight

### SPECS + FEATURES

- Constructed of 1" wide double box-stitched nylon webbing with heat-sealed ends to prevent fraying.
- Snap: 15" length; 13" length ( includes hardware)
- Non-rust manganese bronze 225 snaps are 4-1/4" long
- Welded nickel plated rings are 2" in diameter

SKU	ATTRIBUTE	PRODUCT
0898211	snap	Chainsaw Strap With Snap
0898213	ring	Weaver Chainsaw Loop With Ring

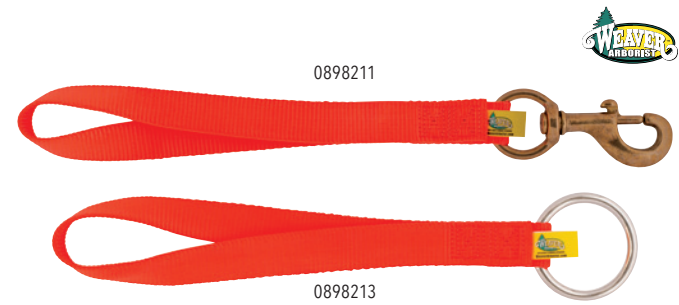

## BUCK Tear Away Bungee Chainsaw Lanyard

**BUCK's Tear Away Bungee Chainsaw Lanyard** features a built-in bungee designed for a safety and convenience. It is constructed with a tear away safety pack that activates when 200 lbs. of force is applied. This feature eliminates the possibility of the user being pulled out of a tree if the saw gets hung up on a falling limb.

### SPECS + FEATURES

- 1-3/4" ring to store when not in use
- Elastic bungee designed for safety and convenience
- Bungee extends to 48"
- Not to be used with saws exceeding 15 lbs. in weight

SKU	ATTRIBUTE	PRODUCT
25Y13-48A	Hi-vis Green	Chainsaw Bungee Lanyard



## US Rigging Breakaway Chainsaw Lanyard

### SPECS + FEATURES

- 42" in length, 5" loop and brass swivel snap
- Breakaway design
- Constructed from kernmantle rope

SKU	ATTRIBUTE	PRODUCT
LYB-08Y-42	42"	Breakaway Chainsaw Lanyard





## Teufelberger antiSHOCK Chainsaw Lanyard



The **antiSHOCK Tool Lanyard** is a versatile lanyard for various tree care tools.

### SPECS + FEATURES

- In the event that more than 220-240 daN act on the lanyard, the tear webbing will be activated reducing the force that acts on the harness, the fall protection system, and the anchor point to 150-180 daN.
- The webbing is torn open until the impact force has been absorbed.
- Elastic webbing is exceptionally abrasion resistant.

SKU	ATTRIBUTE	PRODUCT
7350845		Lanyard antiSHOCK Chainsaw



## Edelrid Mini Tool Lanyard



The **Edelrid Mini Tool** is a safety leash for securing tools.

### SPECS + FEATURES

- 10 mm wide webbing with large girth hitch loop on the tool end has a drawstring stopper for versatility and the other end is terminated by an integrated carabiner for attaching to your harness
- Lightweight, compact
- MBS: 20 kg | 44 lbs

SKU	ATTRIBUTE	PRODUCT
814711350170	4.5'	Mini Tool Lanyard



## Weaver Web Loop Runner



### SPECS + FEATURES

- These lightweight loop runners are as strong and durable as rope.
- Circular construction distributes wear more evenly
- Use for medium-duty speed line chokers, line redirections, miniature false crotch support systems, a limb handle or providing a footstep where none exists.
- MBS: 6500 lbs
- Ultimate Breaking Strength: 7100 lbs

SKU	ATTRIBUTE	PRODUCT
0898230PU	Purple	12" Web Loop Runner
0898231BL	Blue	24" Web Loop Runner
0898232OY	Yellow	30" Web Loop Runner
0898233BO	Orange	36" Web Loop Runner
0898234RD	Red	48" Web Loop Runner

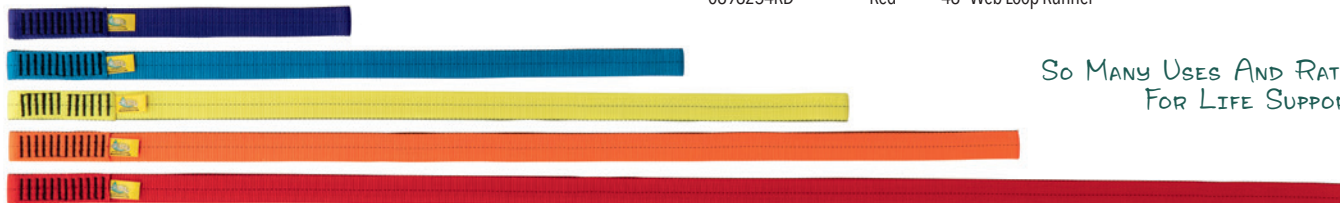

SO MANY USES AND RATED FOR LIFE SUPPORT!

## CMI Heavy Duty Loop Runner



These are, quite simply, the strongest runners available today.

### SPECS + FEATURES

- A heavy duty twist to our ever popular regular sewn runners.
- Continuous loops of 1" heavy duty webbing.
- MBS: 14,000 lbs

SKU	ATTRIBUTE	PRODUCT
AAS48HD	48"	Heavy Duty Web Loop Runner



## CMI Web Loop Runner



### SPECS + FEATURES

- CMI strong 1" tubular webbing runners are known for their bar-tacks.
- Great quality, great price
- Continuous 1" webbing loop
- Strength: 6000lbs

SKU	ATTRIBUTE	PRODUCT
AAS60ORANGE	60"	Web Loop Runner



AVAILABLE IN ADDITIONAL COLORS

# harness accessories

HARNESSES / ACCESSORIES

## Edelrid SM Clip 3R

Large gear carabiner for clear storage and organization of ice screws and other climbing equipment on the harness. Increase your carrying and equipment storage options.

### SPECS + FEATURES

- Suitable for all climbing harnesses
- Made from recycled rope material
- Weight: 44 g

SKU	ATTRIBUTE	PRODUCT
744150000170	Large	SM Clip 3R

EDELRID 



## Rock Exotica transPORTER Tool Carrier

The **transPORTER** is designed as a harness "tool-holder" made for ease of use and security. The gate is equipped with a manual locking mechanism and "wing" design. Unique "wings" on the gate allow the user to single-handedly retrieve and sort gear, even with gloves on. The **transPORTER** semi-permanently attaches to the harness, secured by an aluminum plate with removable screws. Machined from solid aerospace grade aluminum.

### SPECS + FEATURES

- Wide, flat base keeps the transPORTER upright & secure
- Shelf provides area to stack and sort gear
- Winged gate for easier access with gloves
- Manual locking gate
- Installs on a wide range of harnesses, and thickness of webbing
- Includes 2 sets of screws to accommodate different thickness of webbing

SKU	ATTRIBUTE	PRODUCT
C5M		transPORTER Tool Carrier

rock exotica



## DMM Vault Tool Holder

**DMM's Vault** for gear storage and organization on harnesses, kit bags or in vehicles.

### SPECS + FEATURES

- Made of two part aluminum alloy, to maximize torsional rigidity
- Available with: wiregate or locking gate.
- Locking gate prevents accidental openings and provides greater security with the option to select between open and manually locked.
- One handed operation for ease of use
- Low nose profile minimizes mid-move branch grabs
- Weight Wire: 63 g
- Weight Locking: 79 g
- Locking version: 2 positions: unlocked or locked
- Max webbing size: 45 x 3 mm
- WLL: 3 kN

SKU	ATTRIBUTE	PRODUCT
A552	Locking	Vault Tool Holder
A558	Wire Gate	Vault Tool Holder

DMM







## CMI Shembiner Chainsaw Clips

The **Shem** is a high grade, lightweight, aluminum hook engineered to hold your chainsaw close to your harness. Created by arborist, Shem Kendrick to address the ergonomic repetitive motion of the on/off to your harness... now easier.

The newer XL **Shembiner** is a bit bigger and with a great additional feature of an added hole at the base so you can attach a chainsaw lanyard directly to the **Shembiner** XL, or to carry more gear.

### SPECS + FEATURES

- Easy stowing of your chainsaw without clips or gates
- Invert without loosing your saw
- Light weight, high strength
- No gates to fiddle with

SKU	ATTRIBUTE	PRODUCT
SHEMBINER REG	Regular	Shembiner Chainsaw Clip
SHEMBINER XL	XL	Shembiner Chainsaw Clip



## CAMP Kilo Gear Carabiner – New!



Meet the lightweight and sleek **Kilo**. Featuring a proprietary design that makes it robust, stable and easy to use. Two-part aluminum alloy body connects with two stainless steel Torx TH20 screws making installation quick and simple.

### SPECS + FEATURES

- Stainless steel wire gate is shaped for smooth action
- Low profile to prevent entanglement and accidental opening
- Fits harnesses onto webbing (up to 45 mm thick)
- Included: Torx TH20 allen wrench
- Weight: 1.9 oz
- WLL: 20 kg | 44 lbs
- MBS: 150 kg | 330 lbs

SKU	ATTRIBUTE	PRODUCT
012728		Kilo Gear Carabiner

SUPER LIGHTWEIGHT



## DMM Captain Hook Kit



**DMM Captain Hook Kit** comes with 15M of 10 mm Sirius Reepshnur, an XSRE carabiner and **DMM Bag**. The **Captain** is a self-orientating, high strength throwing hook that is used as a positioning aid. It has been designed to increase stability and create work positioning options during complex jobs.

### SPECS + FEATURES

- The shackle reduces torsional friction and allows the hook to pivot onto any anchor to achieve reliable location.
- Captain allows you to use remote anchors up to 90 mm in diameter to traverse the workspace in a controlled manner.
- Once the anchor has been located, DMM's high quality engineering ensures the Captain achieves a rated strength of 18 kN (dependent on anchor quality).
- Clever design allows the device to be efficiently racked when the job is done to minimize chances of snagging.
- MBS: 18 kN
- Dimensions: 310 x 150 x 190 mm
- Weight: 1771 g

SKU	ATTRIBUTE	PRODUCT
TH100-KIT	Red & Black	Captain Hook Kit
TH100	Red	Captain Hook



# harness accessories

HARNESSES / ACCESSORIES

## CAMP Gyro Multi-Anchor Swivel

**CAMP**

A compact and extremely versatile rigging system featuring CAMP's proprietary triple swivel design.

### SPECS + FEATURES

- Rotates at all three connection points
- Allows for countless possibilities of connection between different elements that need freedom of movement. (Hole diameter: 3 x 16 mm)
- Prevents the accumulation of dirt and makes inspection easy.
- Main structure is carbon steel with a double corrosion preventive coating.
- Stainless steel swivel balls and attachment points also includes 3 removable silicon anti-rotation inserts.
- Weight: 155 g | 5.5 oz.
- WLL: 3 kN | 374 lbs
- MBS: 26 kN | 5845 lbs
- Certs: ANSI Z359.12

SKU	ATTRIBUTE	PRODUCT
2940		Gyro Multi-Anchor Swivel



## Singing Tree Milled Quickie



Developed by Kevin Bingham, the inventor of the Rope Wrench and Rope Runner, the Original **Quickie** is a locking steel connection that can be used for nearly everything you would use a carabiner for – and more.

### SPECS + FEATURES

- Half the size of standard carabiners
- Makes a great connection for a base anchor or canopy anchor because it experience the side loading problems of a standard carabiner
- The quadruple action slic pin rotates, lowering friction when used to choke a rope
- Major Axis: 30kN; Minor Axis: 15kN
- Dimensions: Length: 2.25"; Width (no slic pin): 1.5"; New Slic Pin Length: 2.5"; Sideplate Width: 0.875

The Quickie pin is not compatible with other Singing Tree devices.

SKU	ATTRIBUTE	PRODUCT
23180-80043		Singing Tree Milled Quickie



Image courtesy of Teufelberger



# fall arrest + utility

## CAMP FOCUS Full Body ANSI Vest



A streamlined fall arrest harness featuring with an integrated padded vest that wraps around the upper body with dual certification (ANSI + EN). Proprietary ANSI STS automatic buckles on the legs loops and sternal make this harness extremely quick and easy to put on and take off.

### SPECS + FEATURES

- Equipped with 2 removable front zip pockets.
- Certified break-away parking loops for lanyards on the shoulders.
- 2 steel attachment points for fall arrest with certified load indicators: 1 sternal and 1 dorsal.
- Two gear loops.
- Weight: 1850 g, 65.3 oz
- Standard(s): EN 361 - ANSI Z359.11
- One size fits all: Waist (80-140 cm); Legs (45-75 cm); Height (50-90 cm)

SKU	SIZE	PRODUCT
2664	UNI	Focus Full Bod Vest ANSI



INCREDIBLY COMFORTABLE. EASY TO ADJUST

## CAMP FOCUS Full Body Light ANSI Harness



Basic, lightweight fall arrest harness with dual certification (ANSI + EN). Focus Light ANSI satisfies the strict regulatory needs of workers at height in many parts of the world. Proprietary ANSI STS automatic buckles on the legs loops and sternal make this harness extremely quick and easy to put on and take off.

### SPECS + FEATURES

- Certified break-away parking loops for lanyards on the shoulders.
- 2 steel attachment points for fall arrest: 1 dorsal with certified load indicator and 1 sternal (no load indicator).
- Two gear loops
- Weight: 3.14 lbs.
- Standard(s): EN 361 - ANSI Z359.11
- One size fits all: Waist (80-140 cm); Legs (45-75 cm); Height (50-90 cm)

SKU	SIZE	PRODUCT
2663	UNI	Focus Full Body Light ANSI Harness



## BUCK Bucket Harness H-Style with Quick Clips

An H-style full body harness with a steel D dorsal attachment and split tongue quick connect buckles with leather chafes on chest and leg straps. Friction buckles are mounted on vertical shoulder strap for height adjustment.

### SPECS + FEATURES

- H-style full body harness with steel D dorsal attachment
- Split tongue quick connect buckles with leather chafes on chest and leg straps
- Friction buckles mounted on vertical shoulder strap for height adjustment
- Meets all applicable ANSI, OSHA and/or ASTM standards
- Meets ASTM Electric Arc Performance Requirements

SKU	SIZE	PRODUCT
68D98C600S	S	H-Style w/ Quick Clips
68D98C600M	M	H-Style w/ Quick Clips
68D98C600L	L	H-Style w/ Quick Clips
68D98C600XL	XL	H-Style w/ Quick Clips



# fall arrest + utility harnesses

HARNESSES / FALL ARREST + UTILITY HARNESSES

## BUCK OSHA Harness-Lanyard Combo

### SPECS + FEATURES

- Safety Green Webbing
- H-Style harness
- Interlocking Chest & Leg Buckles to ensure comfort
- Includes 4-1/2' BuckYard Lanyard, a great value add-on.
- Material: Nylon

### SPECS

- Universal Size (Fits Medium- X-Large)
- Fall Protection: Class A (Fall Arrest/Fall Restraint)
- Standards: ANSI Z359.11, Z359.13 and ASTM F887-13 for ARC Flash.
- User Weight Capacity: 350 lbs
- Weight: 4.35 lbs

SKU	SIZE	PRODUCT
U64937Q6	M-XXL	OSHA Harness-Lanyard Combo



BUCKINGHAM  
**BUCK**  
1880

## Edelrid Flex Lite Full Body Harness

EDELRID

### SPECS + FEATURES

- Fall indicator in the back padding; a red label becomes visible in the window in the back plate following a load of over 6 kN
- All load-bearing straps are equipped with indicator tape; red fibers become visible in the event of damage
- Shoulder padding with RFID pocket, labeling field and attachment option for the wireless device
- Easy Glider buckle on the shoulder straps for easy adjustment, detachable strap keeper for cleanly stowing away the straps
- Detachable leg padding
- 3D mesh with a closed surface structure prevents the adhesion of dirt and chippings and enables good air circulation
- Triple Lock buckles on the legs and hips for extra safety
- Textile fall arrest eyelets 2x type A/2 sternal and 1x A dorsal according to EN 361; remain open under preload and allow a further carabiner to be easily attached
- Standards: CE marking: CE 0123
- Sizes: S-M: 155 - 180 cm L-XXL: 175 - 205 cm

SKU	SIZE	PRODUCT
880860292190	S-M	Flex Lite Full Body Harness
880860302190	L-XXL	Flex Lite Full Body Harness



## Edelrid Fraggie III Kids Full body Harness

EDELRID

### SPECS + FEATURES

- Padded full body harness
- Easy to put on and to adjust- stiff construction and fixed leg loops with two Slide Block buckles
- Two large tie-in loops offer enough space for two carabiners clipped in opposite directions (e.g. for top-roping).
- Fraggie is extra special because it can be sized as the little person grows!
- Certs: The Fraggie is fully manufactured in compliance with the strict bluesign® system requirements
- Capacity: 40 kg | 88 lbs
- XXS Waist: 45 - 55 cm Legs: max. 37 cm Weight: 307 g | 10.8 oz
- XS Waist: 50 - 60 cm Legs: max. 48 cm Weight: 271 g | 9.5 oz

SKU	SIZE	PRODUCT
749080033290	XXS	Fraggie III Kids
749080043290	XS	Fraggie III Kids





## Kong Sierra Duo Bucket Harness

**Kong Sierra Duo Bucket Harness** changes the comfort of work positioning and fall arrest when combined with positioning Safety Belt

### SPECS + FEATURES

- Lightweight
- Practical and safe
- Economical
- Equipped with three anchor points (sternal, ventral and dorsal)
- Stainless steel buckles and dorsal attachment point
- Equipped with two wide gear loops
- Sizing: M/L - 28-41" XL - 35-51"

SKU	SIZE	PRODUCT
8W0053000KK	M/L	Kong Sierra Duo
8W0055000KK	XL	Kong Sierra Duo

ECONOMICAL,  
COMFORTABLE,  
SIMPLE DESIGN



## Elk River Universal 1-D Harness

### SPECS + FEATURES

- Three steel D-rings: 1 positioned in the back of the harness and the other 2 are one positioned at each hip
- Parachute mating buckle on each chest strap
- 42109 - Parachute buckles on each leg strap or 42159 - Tongue buckles on each leg strap
- Shoulder strap adjusters
- Fall indicators
- Lanyard parks
- Constructed from polyester and nylon
- One size fits most (M-2XL)
- Fall Protection: Class A

SKU	PRODUCT
42109	Universal 1 D Harness w/Parachute Leg Buckles
42159	Universal 1 D Harness w/Tongue Leg Buckles

Elk River, Inc.  
Personal Fall Protection



## Elk River Universal 3-D Harness with Tongue Leg Buckles

### SPECS + FEATURES

- Three steel D-rings: 1 positioned in the back of the harness and the other 2 are one positioned at each hip
- Parachute mating buckle on each chest strap
- Tongue buckles on each leg strap
- Mating buckle on chest straps
- Tongue buckles on leg straps
- Shoulder strap adjusters
- Fall indicators
- Constructed from polyester and nylon
- Lanyard parks
- Fall Protection: Class A, Class P
- One size fits most (M-2XL)

SKU	PRODUCT
42359	Universal 3 D Harness w/Tongue Leg Buckles

Elk River, Inc.  
Personal Fall Protection



# fall arrest lanyards

## BUCK BuckYard Stretch™ ANSI

### SPECS + FEATURES

- Will expand/stretch to 6' when worked and will retract to 44"
- Same benefits of the standard BuckYard with the addition of an elastic bungee
- 1706 locking snap hook on one end and web loop on the other end

SKU	PRODUCT
84V714.5S1	BuckYard Lanyard ANSI Snap-Loop



## BUCK BuckYard Lanyard – Snap to Snap

### SPECS + FEATURES

- 1706 locking snap hook on both ends.
- Maximum Elongation: 48"; Maximum Free Fall: 6'
- Average Arresting Force: 900 lbs
- User Weight Capacity: 350 lbs
- Standards: ANSI Z359.13, ASTM F887, CSA Z259.11

SKU	LENGTH	PRODUCT
8W114S1	4'	BuckYard ASTM Snap-Snap Lanyard 4'
8W114.5S1	4.5'	BuckYard ASTM Snap-Snap Lanyard 4.5'
8W115S1	5'	BuckYard ASTM Snap-Snap Lanyard 5'



## BUCK BuckYard Stretch Lanyard – Snap to Snap

### SPECS + FEATURES

- 1706 locking snap hook on both ends.
- Maximum Elongation: 48"; Maximum Free Fall: 6"
- Average Arresting Force: 900 lbs
- User Weight Capacity: 350 lbs
- Standards: ANSI Z359.13, ASTM F887

SKU	PRODUCT
8W714S1	BuckYard ANSI Lanyard with Snap



## Kong EAW I Bucket Lanyard with Tango Snap

### SPECS + FEATURES

- Energy absorber 30 mm polyamide elastic sling reduces the impact force. The energy of the fall is absorbed by the tearing of specific webbing.
- Mesh pouch protects from abrasion, allows quick verification of condition
- Double locking, MBS: Long axis 32 kN, short axis 12 kN, open gate 15 kN
- Length: 5'

SKU	ATTRIBUTE	PRODUCT
201SETE05KK	Tango Snap 5'	EAW I Bucket Lanyard with Snap
201E090YOKK	3'	EAW I Bucket Lanyard

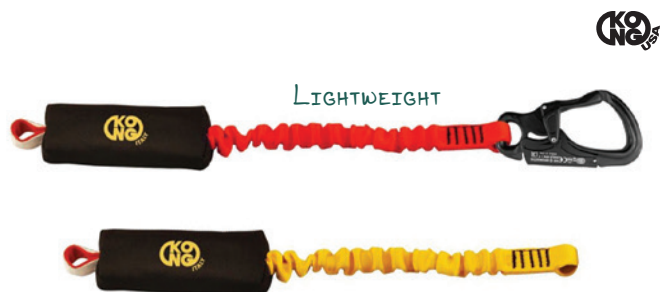



# 5 | climbing



THROW WEIGHTS, LINES, AND KITS.....	128
FRICION MANAGEMENT.....	132
CARABINERS.....	135
SNAPS.....	146
SWIVELS + PULLEYS.....	148
LANYARDS.....	152
PRUSIKS + SPLIT TAILS.....	162
MECHANICALS.....	168
ASCENDERS.....	174
BASAL ANCHORS.....	177
DESCENDERS.....	178
CLIMBERS + SPIKES.....	181

# throw weights, lines, and kits

## Weaver Throw Bag Cordura

Weaver's aerodynamic **Cordura** throw weights are designed to help increase the range of the throw.

### SPECS + FEATURES

- The moving action of the #8 shot that fills these helps prevent the weights from hanging up in tree branches.
- The coated lead shot is contained in a latex pouch.
- A 7/8" nickel plated ring for attachment of a rope or poly pilot line is box-stitched.
- Weight: 10 oz, 12 oz, 14 oz (printed on throw weight)

SKU	ATTRIBUTE	PRODUCT
08-98318-HP	12 oz Pink	Throw Bag Cordura
08-98319-HP	14 oz Pink	Throw Bag Cordura
08-98319-HP	16 oz Pink	Throw Bag Cordura
0898320RD	16 oz Red	Throw Bag Cordura



## Weaver Hi-Viz Throw Bag Bullet with Loop

### SPECS + FEATURES

- Sleek, aerodynamic design features contrasting colors that are easy to see
- The moving action of the #8 shot that fills these helps prevent the weights from hanging up in tree branches.
- The coated lead shot is contained in a latex pouch for environmental protection.
- A 7/8" nickel plated ring for attachment of a rope or poly pilot line is box-stitched.
- Weights: 8 oz, 10 oz, 12 oz, 14 oz, 16 oz (printed on throw weight)

SKU	ATTRIBUTE	PRODUCT
08-98322-BK/BO	8 oz Orange	Throw Bag Hi-Viz Loop
08-98323-BK/NG	10 oz Green	Throw Bag Hi-Viz Loop
08-98324-BK/YE	12 oz Yellow	Throw Bag Hi-Viz Loop
08-98322-BK/HP	8 oz Pink	Throw Bag Hi-Viz Loop
08-98323-BK/HP	10 oz Pink	Throw Bag Hi-Viz Loop
08-98324-BK/HP	12 oz Pink	Throw Bag Hi-Viz Loop
08-98325-BK/HP	14 oz Pink	Throw Bag Hi-Viz Loop
08-98320-HP	16 oz Pink	Throw Bag Hi-Viz Loop



## Jameson Throw Bag

High visibility color canvas bag with metal ring for line attachment. Attach **Jameson** throw line to **throw bag** to launch over tree limbs with Tru Shot Launcher.

### SPECS + FEATURES

- Metal ring makes a quick assembly process for connecting to throw line
- Great visibility
- Flies smooth and pairs with TruShot Launcher
- Weight: 14 oz.

SKU	ATTRIBUTE	PRODUCT
TB-14	14 oz Green	Throw Bag

CONNECT YOUR CLIMBING LINE TO LOOP ON THE BOTTOM FOR A QUICK ENTRY INTO THE TREE.







## Wuerfsackchen European Throwbag

For those climbers who have been around a while this "little bag" will remind you a lot of the Harrison Rockets. Small, light, strong and sexy.

### SPECS + FEATURES

- Lightweight and flies smooth
- Loop on bottom to attach climbing line
- Weight: 250 g | 8.8 oz

SKU	ATTRIBUTE	PRODUCT
THROWBAG	250 g Orange	Throwbag



TWO RINGS AT THE TOP TO QUICKLY CONNECT THROWLINE.

## Teufelberger dynaGLIDE Throwline



Throwline of pure Dyneema **dynaGLIDE** from **TEUFELBERGER** is a coated throwline that, due to its neon colors, is easily visible in trees. **dynaGLIDE** with a coating which ensures very little elongation and better gliding characteristics on bark.

### SPECS + FEATURES

- Soft hand
- Very high strong, polyurethane coating for better abrasion resistance
- Smooth surface gliding readily over rough bark
- MBF: 380 daN | 800 lbs
- Diameter: 1.8 mm | 1/14"
- Weight: 0.16 lbs per 100' | 2.4 g per meter
- Lengths: 45 m, 60 m
- 12-Strand hollow braid with a UHMPE cover

SKU	ATTRIBUTE	PRODUCT
15270200150	150' Green	dynaGLIDE Throwline
C1527-02-00200	200' Green	dynaGLIDE Throwline
15250200200 DYNAGLIDE	200' Orange	dynaGLIDE Throwline



EASILY SPICED WITH A MICRO FID!



## Samson Zing-It

Zing-It! is a great throwline, tried and true.

### SPECS + FEATURES

- High strength but lightweight with a low stretch
- Long wear, samthane coating
- Great knot-holding capability
- Fiber: Dyneema
- Spliceable: Yes
- Length: 180' prepackaged

SKU	ATTRIBUTE	PRODUCT
811017101850	180' of 1.75 mm	Zing-It Throwline
811022101850	180' of 2.2 mm	Zing-It Throwline



COMES IN TWO DIAMETERS

## Weaver Slick Line 1/8"



Weaver's Polyethelen Slick Line is conveniently packaged in a bag. Great economical throwline for beginners or those on a tight budget.

### SPECS + FEATURES

- Lightweight design is ideal for positioning other ropes.
- 1/8" Yellow Slick Line with an 8 carrier diamond braid polyethylene cover over a parallel polyethylene core.
- Comes with a 12 oz Orange Cordura Throwball
- MBS: 190 lbs

SKU	ATTRIBUTE	PRODUCT
08-98327-80	12 oz 150'	Slick Line 1/8" and 12 oz Orange Throwball
08-98025-150	150'	Slick Line 1/8" - Line Only



# throw weights, lines, and kits

CLIMBING / THROW WEIGHTS, LINES, AND KITS

## Yale Long Shot 1.8 mm

Meet **Yale's** throw line which is made of Ultra High Molecular Weight Polyethylene (UHMWPE) fiber.



### SPECS + FEATURES

- Coated with Maxijacket for toughness and anti-snagging
- Solid-braid structure, creating a firmer, rounder construction
- Creating less friction on the surface area of the branch to line.

SKU	ATTRIBUTE	PRODUCT
91005ZMC000200	200'	Long Shot

## All Gear Bulls Eye Throwline 2.5 mm

**All Gear's Bulls Eye Throwline** is made with Polyethylene and Dyneema to combine for added strength and a slick design.



### SPECS + FEATURES

- Rot-resistant line has good memory for recoiling
- This high visibility throwline glides easily in the hands
- ABS: 450 lbs

SKU	ATTRIBUTE	PRODUCT
AGDPTL25180	180'	Bulls Eye Throwline 2.5 mm - Green
AGDPTL251000	1000'	Bulls Eye Throwline 2.5 mm - Green

## All Gear Target Throwline 1/8"

**All Gear's Target throwline** is made to be extremely slick and strong. It has a striped pattern for visibility and is braided firmly to avoid snagging and abrasion.



### SPECS + FEATURES

- Rot-resistant line has good memory for recoiling
- Color: Neon orange/yellow
- ABS: 250 lbs

SKU	ATTRIBUTE	PRODUCT
AGPTL18200-TARGET	200'	Target Throwline
AGPTL181000-TARGET	1000'	Target Throwline

## All Gear Jet Set Throwline 1.75 mm



### SPECS + FEATURES

- 100% Pre-stretched HMPE® Throw Line in Safety Orange - Hi Visibility
- Strong and long lasting
- Premium Husky Coating to enhance the glide and increase the abrasion resistance even further.
- Construction: 12-strand braid
- Diameter: 1.75mm
- MBS: 450 lbs

SKU	ATTRIBUTE	PRODUCT
AGTL1751000	1000'	Jet Set Throwline



## Jameson Big Shot - Thowball Launcher

Designed to help launch your throwbag and throwline easier and further. Great in tight urban spaces where you can't move back from the tree or desired tie-in point.

### SPECS + FEATURES

- Longer lengthened straps sewn just above the finger hold, new launch pad grips the projectile firmly until released by hand or trigger.
- Position the pole at any angle (even upside down!) without the projectile falling.
- Reinforced elastic connection points where tube meets pouch.
- Includes head, sling and pouch.
- Compatible with Jameson poles: 4', 6', 8'

SKU	PRODUCT
BS1	Big Shot - Thowball Launcher
BS-1RP	Big Shot Thowball Launcher Tube/Pouch Replacement



## NOTCH Big Shot Trigger



The **Big Shot Trigger** attaches securely to any 1.25" diameter pole to increase your accuracy & ease of use.

### SPECS + FEATURES

- Easy to install, just place it on your favorite pole and clamp it down.
- Add your throwball in the the pouch & pull down; secure the finger hold on the latch. Locate your ideal branch, lift the safety, stand clear and await your return audible & pull the trigger!
- 80+ feet, no problem... you got this!

SKU	ATTRIBUTE	PRODUCT
50011		Big Shot Trigger



## DTX Shoulder Shot Gun



Powered by air with a bicycle pump! The **Shoulder Shot** is an awesome tool. Used by many industries when folks don't have the opportunity to get great at throwline.

### SPECS + FEATURES

- This launcher is air propelled by a bicycle pump, yep that easy.
- The launcher can reach vertical heights above 100' while using a lightweight throwbag with accuracy.
- Made of solid stainless steel and all non corrosive material.
- Best used with 10 oz or 12 oz throwbags.

SKU	ATTRIBUTE	PRODUCT
0619175671528		Shoulder Shot Gun

THIS AIR-PROPELLED LAUNCHER CAN REACH HEIGHTS ABOVE 80' WITH ACCURACY!



# friction management

## Teufelberger flmbISAVER

The **flmbISAVER** from Teufelberger is a cambium saver provided with steel thimbles. The perfect tool for tree care operations in canopies. The **flmbISAVER** is robust and durable and impresses with its high breaking load.

### SPECS + FEATURES

- 2 stainless steel thimbles [flmb] ensure that the climbing rope will move smoothly during work in the canopy.
- Friction values are only slightly higher than those with the pulleySAVER.
- 10 cm long and tapering longitudinal seam makes retrieving this saver easy.
- Easy to install from the ground, it closes the gap between the multiSAVER and the pulleySAVER.
- Diameter: 15 mm (11/32")
- MBS: 4,000 daN (8,990 lbs)
- Replaceable parts: Ocean Polyester Loop, Retrievable Cone L
- Standards: EN 795B:1996, EN 795B:2012, ANSI Z133-2012"

SKU	ATTRIBUTE	PRODUCT
008374	1.25M	flmbISAVER
008375	2M	flmbISAVER



## Teufelberger pulleySAVER

The **pulleySAVER** from Teufelberger and TreeMagineers epitomizes the evolution of the friction saver.

The **pulleySAVER** can be used as anchor point on a tree and can configured four different ways: As swinging element in a double leg configuration, As choke hitch, Wound around in a double leg configuration, or Narrowed in a double leg configuration.

### SPECS + FEATURES

- Climbing rope moves extremely easily on the Pinto pulley.
- Resilient eye allows the retrieval of the pulleySAVER.
- Eye will return into its original position even after a thousand cycles.
- Teufelberger's patented slaiice

SKU	ATTRIBUTE	PRODUCT
7350820	1.25M	pulleySAVER
7350835	2.5M	pulleySAVER



7350820



7350835



## ART RopeGuide TwinLine Friction Saver

The **RopeGuide TwinLine** can be used in two ways. As a friction saver rope guide style anchor on a short, spliced eye sling (the Gravity Lab Sling with a sprung eye is ideal), or a long rope (10 to 12 mm diameter) in any suitable length with no need for end terminations.

### SPECS + FEATURES

- Mobile anchor point – easy re-tightening of the rope when changing the anchor point by the auxiliary roller Ally (no PSA)
- Integrated ZipAbsorber (absorbing systems)
- Installation and removal of the long-rope system from the ground
- Constructed aluminum body and attachments made from the solid in the machining process
- Infinitely variable length
- Trapeze 4 shackles
- Minimum Breaking load: 18 kN
- Max service life: 10 years for all metallic and 5 years for all textile components
- According to EN 795 B (temporary stop means), CEN / TS 16415: 2013 (use with two people at the same time) and according to EN 355: 2002 (shock absorber) certified.
- Does not include ART Splice Anchor

SKU	ATTRIBUTE	PRODUCT
39799		RopeGuide Twinline



## BUCK ArborMaster Friction Savers

**ArborMaster Friction Savers** [patented] allow for easy installation and retrieval.

### SPECS + FEATURES

- Less bend radius and Less friction (easier to climb)
- Reduced wear to a rope
- Can be used as a false crotch
- Rated for human support only
- Color coded for easy retrieval: Green = go (small ring), Red = no (large ring)
- Model 57 anodized aluminum ring friction saver
- Model 57S steel ring friction saver

SKU	ATTRIBUTE	PRODUCT
5724	24"	Aluminum Friction Saver
5736	36"	Aluminum Friction Saver
5748	48"	Aluminum Friction Saver
5760	60"	Aluminum Friction Saver
5772	72"	Aluminum Friction Saver
57S24	24"	Steel Friction Saver
57S36	36"	Steel Friction Saver
57S48	48"	Steel Friction Saver



ALUMINUM OR STEEL RINGS

## CAMP Herbol Friction Saver

### SPECS + FEATURES

- Soft anchor system designed to create anchor points from tree branches or around horizontal man-made structures
- Strap has been designed to hold up to the rigors of tree work and protect the tree
- Color-coded anodized end rings that are different sizes to help with installation and removal from the ground when used with a length of cord and the Herbol Retrieval Ball (included)
- MBS: Webbing 22 kN; Large orange ring 30 kN; Small red ring 22 kN
- Made in Italy

SKU	ATTRIBUTE	PRODUCT
214001	90 cm	Herbol Friction Saver
214002	120 cm	Herbol Friction Saver
2141		Herbol Retrieval Ball Replacement



# friction management

CLIMBING / FRICTION MANAGEMENT

## Kong TreeFork Friction Saver

The **TreeFork Friction Saver** provides two differently sized and colored rings, designed to make installation and retrieval from the ground easier.

### SPECS + FEATURES

- Rope friction saver allows for easier rope movement
- Breaking strength: 25 kN
- Length: 48" | 140 cm
- Webbing width: 25 cm
- Certifications: CE EN 795 / B, EN 354 and EN 566

SKU	ATTRIBUTE	PRODUCT
210A140NOKK		TreeFork Friction Saver



## DMM Retrieval Cones

Conical leading edge guides cone through anchor components reliably and with little resistance, then locates in retrieval element. Max diameter tailored to a selection of common tree care anchor components/assemblies.

### SPECS + FEATURES

- High performance polymer - impact resistance, UV tolerance, high dimensional accuracy combine to ensure reliable performance over extended lifespan
- Color coded - Cone S = Yellow | OD 20.5 mm; Cone L = Red | OD 22.3 mm

SKU	ATTRIBUTE	PRODUCT
AR2950C	Yellow	Small - Retrieval Cones
AR2960C	Red	Large - Retrieval Cones

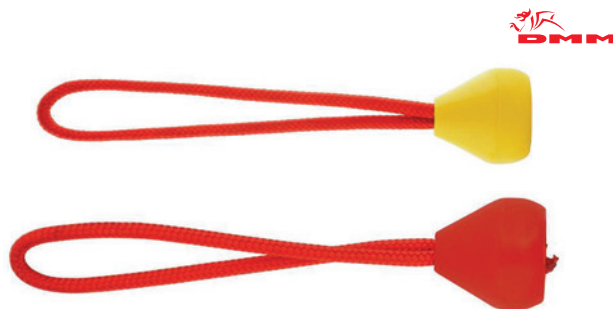

## Weaver Leather Friction Saver

**Weaver's Leather Rope** and cambium saver is a dependable and easy way to protect your climbing rope and tree bark from damage. Also known as the "Shoe" or horseshoe.

### SPECS + FEATURES

- Leather is formed, sewn and riveted into a tube shape
- Easy to install and remove - simply tie a slip knot below the side you are pulling up, once over the limb hold one line tight as you pull down on the knotted side.
- Keep this device installed on rope so it's ready every time the rope is used.
- Accommodates lines: 1/2" - 9/16" or 11 - 13 mm.
- Minimum diameter: 5"

SKU	ATTRIBUTE	PRODUCT
08-98400		Weaver Leather Friction Saver



## Dan House Rope Sleeve Friction Savers

Also commonly known as the "Anaconda" this simple electrical conduit is a rope friction saver and oh so much more.

### SPECS + FEATURES

- Protects your rope and the bark of trees against wear of DdRt
- Provides barrier against water, condensation, snow, ice, slim and more
- Simple to install and remove
- Economical and long lasting
- 13859/13860 Diameter: for ropes of 1/2" and under
- 13861/13862 Diameter: for ropes of 3/4" and under

SKU	ATTRIBUTE	PRODUCT
007796	18"	Rope Sleeve 1/2"
008591	30"	Rope Sleeve 1/2"
008592	30"	Rope Sleeve 3/4"
008593	60"	Rope Sleeve 3/4"





# carabiners

## Rock Exotica Pirate Auto-Lock (Aluminum)

As an HMS, pear-shaped carabiner, the **Pirate** easily accommodates the use of a wide range of gear, webbing or ropes – either as a belay biner at the harness, or as a connector in a system. The **Pirate's** robust 0.5" diameter round frame will endure abuse from dirty ropes and metal connectors far beyond stamped carabiners with thin edges. It's durability matched with **Rock Exotica's** build quality ensures an impressive service life for the working professional or recreational enthusiast.

### FEATURES

- The 3-stage Auto-Locking carabiner features a pull-down and twist action – a motion that's more intuitive and natural for your hand.
- Rock Exotica's WireEye combines the utility of a standard carabiner with the safety and capability of a lanyard pin, or captive eye. Holds gear, lanyards, and lines with enough resistance to help prevent gear from moving past the end of the carabiner, but releases easily.
- Pairs seamlessly with the Unicender and other mechanical devices.

### C1 A & C1 A-B SPECS

- Major axis MBS: 24 kN
- Minor axis MBS: 9 kN
- Open gate MBS: 6 kN
- Inward against sleeve MBS: 6 kN
- Gate opening: 0.93" (22 mm)
- Weight: 2.85 oz (80 gm)

### C1 WEA SPECS

- Major axis ABS: 26 kN
- Minor axis ABS: 12 kN
- Open gate ABS: 7 kN
- Gate Opening: 1" (25mm)
- Weight: 2.9 ounces

SKU	COLOR	PRODUCT
C1A	Orange	Pirate Auto-Lock
C1A-B	Black	Pirate Auto-Lock
C1WEA	Orange	Pirate WireEye Auto Lock



## Rock Exotica rockD (Aluminum)

The **rockD** (C 2A) is a super-strong "D" shaped carabiner optimizes MBS. The **rockD Lanyard Pin** carabiner (C2 LPA) utilizes an easy to remove stainless steel pin which helps prevent gear from moving past the end of the carabiner. The **rockD ORCA-Lock** (C2 O) is a unique gate system that lifts up and twists just like many traditional auto-locks, but can be set to remain in the unlocked position.

### FEATURES

- 3-stage Auto-Locking carabiner features a pull-down and twist action.
- High strength-to-weight ratio in standard size carabiner
- Snag-resistant keylock nose design
- Machined frame ensures tight tolerances and smooth operation

### C2A SPECS

- Major axis MBS: 29 kN;
- Minor axis MBS: 9 kN;
- Open gate MBS: 9 kN;
- Inward against sleeve: 6 kN
- Gate opening: 0.98" (24.9 mm)
- Weight: 2.85 oz (80 gm)

### C2LPA SPECS

- Major axis MBS: 30 kN;
- Minor axis MBS: 11 kN;
- Open gate MBS: 10 kN;
- Inward against sleeve: 6 kN
- Gate opening: 0.96" (24.3 mm)
- Weight: 3.52 oz (99 g)

### C2O SPECS

- Major axis MBS: 26kN;
- Minor axis MBS: 11kN;
- Open gate MBS: 7kN
- Gate Opening: 1.0" (25 mm)
- Weight: 3.12 oz (89 gm)

SKU	COLOR	PRODUCT
C2A	Red	rockD Auto-Lock
C2LPA	Gold	rockD Auto-Lock Lanyard Pin
C2O	Red	rockD ORCA-Lock



# carabiners

CLIMBING / CARABINERS / AUTO-LOCKING-ACTIONS

## Rock Exotica rockO (Aluminum)

Rock Exotica designed the **rockO** (C3 A, C3 A-B) to be a modern oval carabiner that is stronger and features a big gate opening. The **rockO ORCA-Lock** (C3 O) lifts up and twists just like many traditional auto-locks, but can be set to remain in the unlocked position. Allowing it to open easily, just like a non-locker, but close with the security of an auto-lock. The **rockO WireEye** combines the utility of a standard carabiner with the safety and capability of a lanyard pin, or captive eye.

### FEATURES

- The 3-stage Auto-Locking carabiner features a pull-down and twist action
- Designed to center gear and lines in middle of bend radius
- Flattened frame with slim profile and snag-resistant keylock nose design
- Large and ergonomic angled gate opening
- Machined frame ensures tight tolerances and smooth operation

### C3A, C3A-B SPECS

- MBS: Major axis: 24 kN; Minor axis: 9 kN; Open gate: 6 kN;
- Inward against sleeve: 6 kN
- Gate opening: 0.93" (22 mm)
- Weight: 2.85 oz (80 g)

### C3O-B, C3WEA SPECS

- MBS: Major axis: 24 kN; Minor axis: 11 kN; Open gate: 6 kN;
- Inward against sleeve: 6 kN
- Gate Opening: 0.93"
- Weight: 2.85 oz (80g)

SKU	COLOR	PRODUCT
C3A	Plum	rockO
C3A-B	Black	rockO
C3WEA	Plum	rockO WireEye



## DMM Aero HMS Locksafe (Aluminum)



The **DMM Aero HMS** is elegant, pear shaped carabiner – simple to use in most working at height applications. Uses: Fall protection, rescue, rope access, arborist

### SPECS + FEATURES

- Large internal volume and gate clearance
- I-Beam section for increased strength to weight ratio
- Patented Taperlock clean nose for increased gate push in and side resistance
- Hot forged and fully heat treated aluminum individually marked for traceability
- Weight: 91 g
- MBS: Major axis: 25 kN; Minor axis: 12 kN
- Gate Opening: 19 mm
- Cert(s): EN362:2004/B; Anodized to BS EN ISO 7599:2010 class 10 E1 sealed for corrosion protection

SKU	ATTRIBUTE	PRODUCT
A367 Locksafe	Titanium/green	Aero HMS Locksafe



## DMM Zodiac Locksafe (Aluminum)



### SPECS + FEATURES

- Auto-Locking D-shaped carabiner which maximizes the gate clearance.
- I-Beam construction for increased strength to weight ratio
- Keylock clean nose for a snag free connection.
- Hot forged and fully heat treated aluminum individually marked for traceability
- Sealed for corrosion protection.
- Weight: 79 g
- MBS: Major axis: 32 kN; Minor axis: 12 kN; Open gate: 12 kN
- Gate opening: 18 mm
- Cert(s): EN 362:2004 B/T, EN 12275:2013 B

SKU	ATTRIBUTE	PRODUCT
A827 32KN	Titanium/green	Zodiac Locksafe





## DMM Ultra-O Range Locksafe (Aluminum)

DMM's Ultra-O Range or Ultra Range Locksafe triple action carabiner is a perfect companion to the DMM Hitch Climber and Pinto pulleys.

### SPECS + FEATURES

- I-Beam section for increased strength to weight ratio
- Keylock clean nose for snag free connection
- Hot forged and fully heat treated aluminum individually marked for traceability
- Triple colored multipacks allow easy in-system identification
- Weight: 73g
- MBS: Major Axis: 25 kN; Minor Axis: 12 kN; Gate Open: 7kN
- Gate Opening: 19mm
- Cert(s): EN 362:2004 B/T, EN 12275:2013 B; Anodized to BS EN 7599:2010 AA10 Sealed for corrosion protection

SKU	ATTRIBUTE	PRODUCT
A327	Titanium/green	Ultra-O Range
A327-P3	Titanium/green	Ultra-O Range 3 Pack

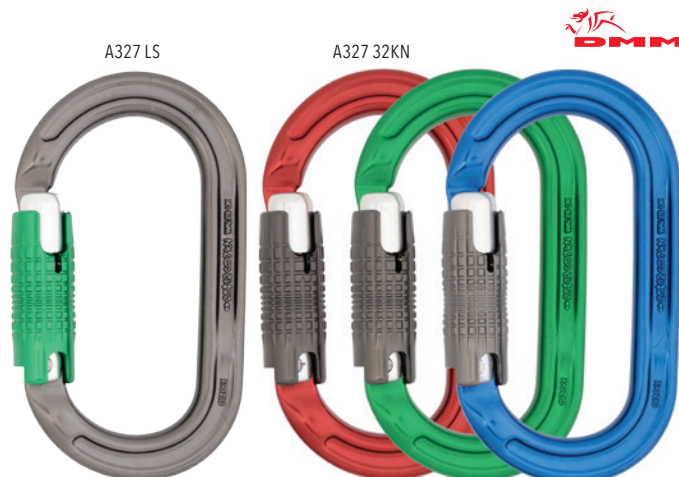

## DMM Ultra-O Durolock (Aluminum)

DMM Durolock is a patented 4-way locking gate mechanism designed to minimize the chances of accidental gate opening and maximize security.

### SPECS + FEATURES

- Operable with one hand, the Ultra-O facilitates multiple connections, the round basket shape allows any of the connections to self-center when weighted.
- Symmetrical baskets mean rotation within systems is not required as they sit comfortably either way round.
- Hot forged and fully heat treated aluminum individually marked for traceability
- Weight: 76 g
- MBS: Major axis: 25 kN; Minor axis: 12 kN; Gate open: 7 kN
- Gate Opening: 20 mm
- Dimensions: 63 x 109 mm
- Cert(s): EN 362:2004 B, EN 12275:2013 B; Anodized to BS EN 7599:2010 AA10 Sealed for corrosion protection

SKU	ATTRIBUTE	PRODUCT
A324	Titanium/purple	Durolock



## DMM Shadow Locksafe (Aluminum)

The DMM Shadow features a massive 9 kN gate open strength and incorporates a new keylock nose. Completely anodized to help combat corrosion and prolong life in hot, or salty environments. Also available pre-drilled with a captive bar option.

### SPECS + FEATURES

- Rope quickly finds the deep basket so the rope is guided towards the spine for added safety.
- Ergonomically this small carabiner fits right in your hand and is easy to find.
- Hot forged and fully heat treated aluminum individually marked for traceability
- Weight: 58 g (2 oz)
- MBS: Major Axis: 24 kN (5,400 lb); Minor Axis: 7 kN; Gate Strength: 9 kN
- Gate Opening: 17 mm
- Dimensions: 2.5 x 4" | 62 x 102 mm
- Approved to EN362:2004/B; Anodized to BS EN 7599:2010 AA10 Sealed for corrosion protection

SKU	ATTRIBUTE	PRODUCT
A307		Shadow
A307-P3	3 Pack	Shadow 3-Pack



# carabiners

CLIMBING / CARABINERS / AUTO-LOCKING-ACTIONS

## DMM Rhino HMS Locksafe (Aluminum)



The **Rhino HMS** carabiner tackles cross loading head on! The horn feature on the leading edge of the spine significantly reduces the possibility of cross loading with rigging, devices, and pulleys by restricting the rotation of devices, whilst the clean nose design provides snag-free gate entry. The smooth and robust top bar is contrasted by our signature I-Beam construction on the non-rope bearing surfaces.

### SPECS + FEATURES

- Weight: 81g
- MBS: Major Axis: 27kN; Minor Axis: 9kN; Gate Open: 7kN
- Gate Opening: 19mm
- Dimensions: 75 x 100mm
- Conformance: EN 362:2004 B, EN 12275:2013 B & H

SKU	ATTRIBUTE	PRODUCT
A547	Titanium/Green	Rhino HMS Locksafe Carabiner



## DMM Klettersteig Locksafe (Aluminum)



**DMM'S Klettersteig** carabiner's wide gate opening and long flat basket make it ideal for clipping webbing and for use in complex rope-running applications. The expanded D shape also keeps the load along the major axis maximizing strength. Large size makes it easy to use with gloved hands. **Klettersteig** connectors look and behave very similarly to Offset Ds, but are wider, helping maximize the gate opening and the internal working volume, whilst still allowing any loads to be located as close to the spine of the connector as possible.

### SPECS + FEATURES

- A847 - Weight: 91g  
MBS: Major Axis: 30 kN; Minor Axis: 14 kN; Gate open: 10 kN  
Gate Opening: 26 mm  
Dimensions: 78 x 120 mm
- A847ANSI - Weight: 109g  
MBS: Major Axis: 30 kN; Minor Axis: 10 kN; Gate open: 16 kN  
Gate Opening: 21 mm  
Dimensions: 77 x 120 mm

SKU	ATTRIBUTE	PRODUCT
A847 Locksafe	Locksafe	Klettersteig
A847ANSI	ANSI Locksafe	Klettersteig



A847 LOCKSAFE



A847ANSI

## DMM Revolver (Aluminum)



The **Revolver's** integrated pulley wheel allows ropes to run more efficiently through the carabiner. Used at changes of direction on a route, it helps reduce rope drag.

### SPECS + FEATURES

- Highly useful for creating lightweight hauling systems.
- Locking gate for extra security

SKU	ATTRIBUTE	PRODUCT
A272	Screw Gate	Revolver
A273	QuicLoc	Revolver
A277	Locksafe	Revolver

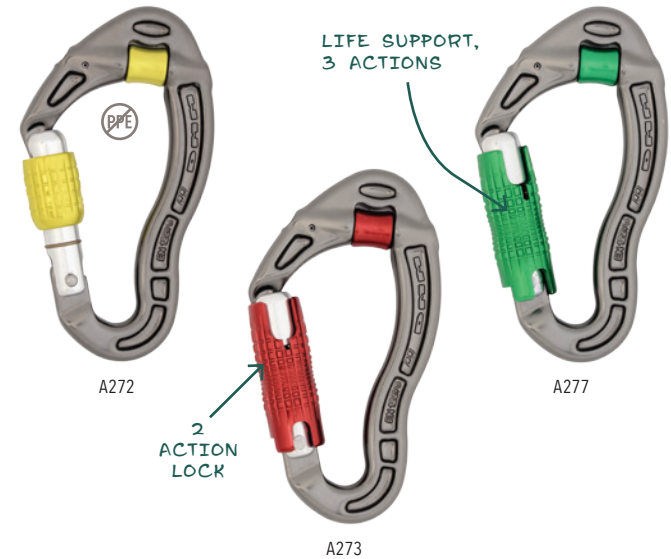

## DMM Perfect-O (Aluminum)



### SPECS + FEATURES

- Compact true oval carabiner that maintains ease of use, even one-handed
- Its shape provides effective centering of loads and the fully rounded rope bearing areas increase carabiner and rope longevity.
- A keylock nose allows snag-free operation.
- Weight: 66 g
- MBS: Major Axis: 24 kN; Minor Axis: 7 kN; Gate Open: 7 kN
- Gate opening: 5 mm
- Dimensions: 95 x 56 mm

SKU	ATTRIBUTE	PRODUCT
A597		Perfect-O Carabiner

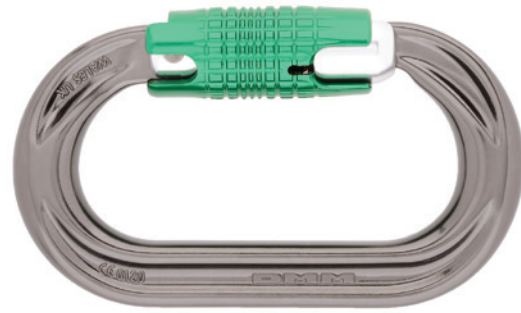



## DMM Phantom HMS Locksafe (Aluminum)



### SPECS + FEATURES

- Extremely lightweight and yet strong, true HMS-shape carabiner
- Extra-short gate means it can take two clove hitches with ease
- Weight: 62 g
- MBS: Major axis: 25 kN; Minor axis: 9 kN; Open gate: 7 kN
- Gate opening: 19 mm
- Dimensions: 71 x 96 mm
- Certification(s): EN 362:2004 B, EN EN12275:2013 B, H & K

SKU	ATTRIBUTE	PRODUCT
A577	Titanium/green	Phantom HMS Locksafe Carabiner

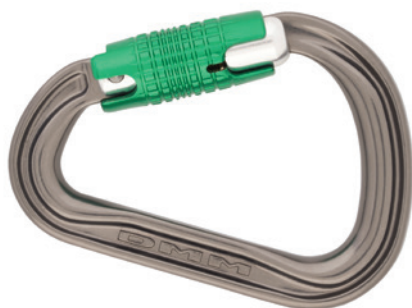

## Edelrid HMS Bulletproof Triple FG (Aluminum)



### SPECS + FEATURES

- Unique design with steel wear plate
- Great for life support systems
- Excellent for speedline applications where locking carabiners are essential
- ABS: 5,600 lbs. | 25kN
- Weight: 0.046 lbs. | 21g

SKU	ATTRIBUTE	PRODUCT
737280003290	Icemint	HMS Bulletproof Triple FG



## Edelrid Oval Power 2500 Triple Locking



Oval carabiner with a very slim locking sleeve. Ideal for clipping rigging plates, pulleys, rope clamps and for positioning anchor points.

### SPECS + FEATURES

- Keylock closure mechanism for optimum handling when clipping and unclipping
- MBS: Vertical: 25 kN; Minor: 9 kN; Open: 7 kN
- Gate opening: 21 mm
- Weight: 76 g

SKU	ATTRIBUTE	PRODUCT
882670000060	Silver	Oval Power 2500 Carabiner



## Kong Ovalone Triple Auto-Locking (Aluminum)



### SPECS + FEATURES

- Triple locking aluminum color anodized
- Dimensions: 110mm x 62.8mm x 21mm
- Major Axis: 26kN | 5,845 lbs
- Meets CE and UIAA standards
- Weight: 1.94 oz (55g)

SKU	ATTRIBUTE	PRODUCT
KNG712	Red	Ovalone



## Kong Ferrata Triple Auto-Locking (Aluminum)



Its special D-shaped bend allows a large aperture (less than 26 mm!) and excellent grip. Auto Block sleeve makes it suitable for professional use on lanyards for progression and positioning.

### SPECS + FEATURES

- Keylock system
- Weight: 3.35 oz (95 g)
- Dimensions: 110 mm x 62.8 mm x 21 mm
- Major Axis: 30 kN | 6,740 lbs
- Meets CE and UIAA standards

SKU	ATTRIBUTE	PRODUCT
KNG778	Black	Ferrata Auto Lock



# carabiners

CLIMBING / CARABINERS / AUTO-LOCKING-ACTIONS

## Kong HMS Pear-Shaped Triple Auto-Locking (Aluminum)

### SPECS + FEATURES

- Improved opening and capabilities
- Keylock system
- Weight: 3.17 oz (90 g)
- Dimensions: 116mm x 78mm x 13mm
- Major Axis: 22 kN | 4,940 lbs
- Meets CE and UIAA standards

SKU	ATTRIBUTE	PRODUCT
KNG786	Red	HMS Pear-Shaped



## Kong Rescue Extra Large Triple Auto-Locking (Aluminum)

### SPECS + FEATURES

- Improved opening and capabilities
- Keylock system
- Weight: 3.35 oz (95 g)
- Dimensions: 114 mm x 76 mm x 13 mm
- Major Axis: 30 kN | 6,740 lbs
- Meets CE and UIAA standards

SKU	ATTRIBUTE	PRODUCT
KNG911	Blue	Rescue Extra Large



## Sterling Falcon (Aluminum)

### SPECS + FEATURES

- Compact, pear-shaped carabiner
- Crafted from high strength 7075-T6 aluminum
- Strong yet Lightweight
- MBS: Major Axis: 5,620 lbs | 25 kN; Minor Axis: 1,574 lbs | 7 kN;
- Open Gate: 1,574 lbs | 7 kN
- EN 12275

SKU	ATTRIBUTE	PRODUCT
HWFALCONAL	Autolock	Falcon



## Sterling Osprey (Aluminum)

### SPECS + FEATURES

- Oval-shaped
- Made with a high-quality, durable aluminum
- Smooth gate and sleeve action
- Key lock and Autolock design
- EN 12275

SKU	ATTRIBUTE	PRODUCT
HWOSPREYALB	Black	Osprey
HWOSPREYAL	Orange	Osprey



## Sterling Safe-D Locking Pin (Aluminum)

### SPECS + FEATURES

- Made from lightweight aluminum
- Removable captive eye pin – allows for attaching rope or webbing
- MBS: Major Axis: 6,295 lbs | 28 kN; Minor Axis: 2,473 lbs | 11 kN;
- Open Gate: 2,023 lbs | 9 kN
- NFPA 1983

SKU	ATTRIBUTE	PRODUCT
HWSAFEDAL		Safe-D Locking Pin Carabiner





## Rock Exotica rockSteel Auto-Lock (Stainless Steel)

The **rockSteel Auto-lock** offers a smooth operating three-stage auto-locking mechanism and smooth keylock surface that won't snag your rope. Our **rockSteel** frames are CNC machined for precise fittings and exact tolerances.

### SPECS + FEATURES

- Impressively strong, yet lightweight
- Rated for inward gate force
- MBS Major Axis: 50 kN; Gate/sleeve: 16 kN (3600 lbs)
- Gate Opening: 1.2" (30 mm)
- Weight: 8.80 oz (246 gm)
- Certification: CE / ANSI / NFPA G – ANSI Z359.12 (09) and NFPA G compliant

SKU	ATTRIBUTE	PRODUCT
M31TL SILVER	Steel	rockSteel Auto-Lock Stainless Carabiner
M31TLN BLACK	Steel	rockSteel Auto-Lock Stainless Carabiner



## Rock Exotica's rockD (Stainless Steel)

Rock Exotica's **rockD Stainless Steel** is an auto-locking carabiner perfect for a wide range of outdoor rigging applications. Great alternative to using a throwball to reposition in the tree. Pairs well with HCP and mechanical devices.

### SPECS + FEATURES

- MBS: Major axis: 41 kN; Minor axis: 17 kN; Open gate: 13 kN;
- Inward against sleeve MBS: 9 kN
- Gate opening: 1.0" (25.4 mm)
- Weight: 7.81 oz (221 gm)
- Certifications: Pending CE

SKU	ATTRIBUTE	PRODUCT
C2SA	Steel	rockD stainless steel Auto Lock
C2SS	Steel	rockD stainless steel Screw Lock



## DMM 12mm Boa HMS Locksafe (Stainless Steel)

The **12mm Boa HMS** has all the versatility of its alloy sibling, but has a rated strength of 40 kN. It can be used for many applications where a large gate opening or high internal volume are required.

### SPECS + FEATURES

- Cold forged
- Weight: 277 g
- MBS: Major axis: 40 kN; Minor axis: 10 kN; Open gate: 12 kN
- Gate opening: 24 mm
- Dimensions: 76 x 123 mm
- Certification(s): EN 362:2004 B, EN EN12275:2013 B, H & K

SKU	ATTRIBUTE	PRODUCT
C857-ID	Steel	Steel 12mm Boa HMS – Light Gold



## Kong Asymmetric Non-Locking with Bar (Stainless Steel)

Great for pairing with webbing straps for speed line lightweight rigging applications.

### SPECS + FEATURES

- Non-locking, clean Keylock nose opening – no snag opening
- Material: 316 Stainless Steel
- MBS: Major Axis: 25 kN; Minor Axis: 10 kN; Gate Open: 8 kN
- Gate Opening: 18 mm
- Dimensions: 99 x 56 mm
- Weight: 126 g

SKU	ATTRIBUTE	PRODUCT
KNG567	Non-Lock	Asymmetric Steel Non-Locking w/ Bar



# carabiners

CLIMBING / CARABINERS / RIGGING

## Kong X-Large C Steel Screw Sleeve (Stainless Steel)

Designed to offer a wide gate opening and a high tensile strength. The shape prevents the rotation of the carabiner and allows to distribute the load along the major axis. Fitted with screw sleeve, easy to open even wearing gloves.

### SPECS + FEATURES

- Clean "keylock" gate - no snagging
- MBS: Major Axis: 50 kN; Minor Axis: 13 kN; Gate Open: 20 kN
- Weight: 240 g
- Gate Opening: 26.5mm
- CE EN 12275; CE EN 362/B; NFPA-G\*; UIAA

\*Testing done on this device satisfy the performances requirements posed by NFPA1983:2017

SKU	ATTRIBUTE	PRODUCT
KNG411SL	Keylock	X-Large C Steel Screw Sleeve



## Kong Ovalone Inox Auto Block ANSI (Stainless Steel)

Oval carabiner with wide-opening. Fitted with Auto Block reinforced sleeve, 3 movements, that increase the resistance in case of lateral stress as required by ANSI norm. Conceived for heavy-duty applications and for connection to structural anchor points, lifelines, etc.

### SPECS + FEATURES

- Keylock system
- Resistant in corrosive environments
- MBS Major Axis: 27 kN
- Weight: 240 g
- CE EN 362/M; ANSI/ASSE Z359.12

SKU	ATTRIBUTE	PRODUCT
5121100K1KK		Ovalone Inox Auto Block ANSI



## Kong X-Large C Steel Auto Block ANSI (Stainless Steel)

A rigging carabiner with a wide gate opening with a triple-locking action for maximum safety. D-shape helps lessen carabiner rotation and allows it to distribute the load consistently along the major axis.

### SPECS + FEATURES

- A reinforced sleeve offers greater resistance to lateral stress and decreases the chance of roll out (Meets ANSI Z359.12)
- Keylock nose prevents snagging
- Triple-locking gate requires three steps to open the gate
- MBS: Major Axis: 50 kN; Minor Axis: 20 kN
- Weight: 265 g
- CE EN 12275; CE EN 362/B; NFPA-G\*; ANSI/ASSE Z359.12; UIAA

\*Testing done on this device satisfy the performances requirements posed by NFPA1983:2017

SKU	ATTRIBUTE	PRODUCT
KNG411	Black	X-Large C Steel Auto Block ANSI



## Kong X-Large Twist Lock Sleeve (Aluminum Alloy)

Asymmetric aluminum carabiner with Twist Lock sleeve. Designed to offer a wide gate opening and a high tensile strength. The D shape prevents the rotation of the carabiner and allows to distribute the load along the major axis. Equipped with Keylock system that prevents snagging on the rope and in the bolts.

### SPECS + FEATURES

- MBS: Major Axis: 30 kN; Minor Axis: 9 kN
- Weight: 95 g
- Gate Opening: 26 mm
- CE EN 12275; CE EN 362/B; NFPA-T\*

\*Testing done on this device satisfy the performances requirements posed by NFPA1983:2017

SKU	ATTRIBUTE	PRODUCT
110PN7VNL	Twist-Lock	XL Steel - Orange





## Spyder Climb Right HMS Carabiner (Aluminum)

Spyder  
MANUFACTURING / USA

### SPECS + FEATURES

- Triple Auto-Locking gate
- Snag-free design at gate opening
- Weight: 3.2 oz (90.7 g)
- Major Axis: 25 kN | 5,620 lbs
- Gate Opening: 0.94" | 24mm
- Meets CE and UIAA standards

SKU	ATTRIBUTE	PRODUCT
85206	Red	Climb Right HMS Carabiner



## Spyder Climb Right Big D Triple Lock (Aluminum)

Spyder  
MANUFACTURING / USA

### SPECS + FEATURES

- Triple Auto-Locking gate
- Snag-free design at gate opening
- Weight: 3.2 oz (90.7 g)
- Major Axis: 30 kN | 6,744 lbs
- Gate Opening: 0.82" | 21 mm
- Meets CE standards

SKU	ATTRIBUTE	PRODUCT
85210	Green	Climb Right Big D Carabiner



## US Rigging ProClimb Big D Triple Lock (Aluminum)

U.S. RIGGING  
SUPPLY

### SPECS + FEATURES

- Popular "D" shape
- Triple Auto-Locking
- Snag-free design
- Weight: 3.5 oz (97 g)
- Major Axis: 28 kN | 6,295 lbs
- Gate Opening: 0.88" | 22 mm
- Meets CE standards

SKU	ATTRIBUTE	PRODUCT
USR107	Silver/Blue	ProClimb Big D Triple Lock Carabiner



## US Rigging ProClimb Copper Head Climber (Aluminum)

U.S. RIGGING  
SUPPLY

### SPECS + FEATURES

- Hybrid design between a "D" and HMS shape, Great for fliplines and lanyards
- Triple auto-locking gate
- Snag-free design at gate opening
- Weight: 3.5 oz (97 g)
- Major Axis: 24 kN | 5,395 lbs
- Gate Opening: 0.90" | 23 mm
- Meets CE standards

SKU	ATTRIBUTE	PRODUCT
USR-128	Copper	ProClimb Copper Head Climber Carabiner



## US Rigging ProClimb True Oval (Aluminum)

U.S. RIGGING  
SUPPLY

### SPECS + FEATURES

- Triple locking gate
- ABS: 5,000 lbs | 22 kN
- Gate Opening: 19 mm

SKU	ATTRIBUTE	PRODUCT
USR-127		ProClimb True Oval Carabiner



# carabiners

CLIMBING / CARABINERS / NON-LOCKING

## DMM XSRE Lock Captive Bar Carabiner

Now available with an optional locking screwgate and captive bar for extra security. The removable threaded captive bar helps ensure the correct orientation with lanyards and holds components securely. The **DMM XSRE Lock Captive Bar Carabiner** is a perfectly formed, high performance accessory clip. It has a functional industrial pedigree, yet crosses over easily into everyday life situations. Widely adopted for non-PPE use on working at height sites, the **XSRE** is just as useful on a tree care harness to organize gear as it is for clipping keys onto a belt loop.

### SPECS + FEATURES

- Symmetrical D shape with a removable threaded captive bar
- Anti-vibration screwgate version for added security
- Hot forged I-beam construction for high strength-to-weight ratio
- MBS: 4 kN
- Weight: 12 g

SKU	ATTRIBUTE	PRODUCT
A482CBMG	Matte Grey	XSRE Lock Captive Bar Carabiner
A482CBBL	Blue/Titanium	XSRE Lock Captive Bar Carabiner
A482CBGR	Green/Titanium	XSRE Lock Captive Bar Carabiner
A482CBLG	Lime	XSRE Lock Captive Bar Carabiner
A482CBOR	Orange	XSRE Lock Captive Bar Carabiner
A482CBPI	Pink/Titanium	XSRE Lock Captive Bar Carabiner
A482CBPR	Purple/Titanium	XSRE Lock Captive Bar Carabiner
A482CBTQ	Turquoise/Titanium	XSRE Lock Captive Bar Carabiner
A482CBRD	Red/Titanium	XSRE Lock Captive Bar Carabiner

ANTI-VIBRATION SCREWGATE

REMOVABLE THREADED CAPTIVE BAR

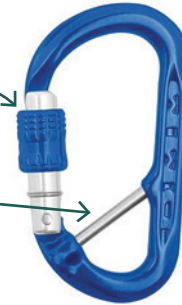

A482CBBL A482CBRD A482CBPR A482CBPI A482CBOR A482CBMG A482CBLG A482CBGR A482CBTQ

NOTE: NOT FOR CLIMBING; NOT PPE

## DMM XSRE (Aluminum)

The **DMM XSRE Carabiner** is small but mighty (consider it a power peanut), easy on the eye and full of attitude this small racking element is the full package. Hot forged I-Beam body provides the backbone of this super strong featherweight. This is the most useful high performance accessory carabiner on the market with hundreds of potential applications. NOTE: NOT FOR CLIMBING; NOT PPE

### SPECS + FEATURES

- Keylock nose aids rope piercing and reduces the chance of snagging
- Plain gate with an oval shape
- MBS: 4 kN
- Weight: 8.1 g

SKU	ATTRIBUTE	PRODUCT
A531RD	Red	XSRE carabiner
A531GR	Green	XSRE carabiner
A531GL	Gold	XSRE carabiner
A531BL	Blue	XSRE carabiner
A531TQ	Turquoise	XSRE carabiner
A531PR	Purple	XSRE carabiner



## Rock Exotica rockX (Aluminum)

### SPECS + FEATURES

- Frame is machined from solid aluminum
- Contours along the top and bottom profile for ease of handling
- MBS: 5kN | 1120 lbs.
- Weight: 0.37 oz (10.4 gm)

SKU	ATTRIBUTE	PRODUCT
C7NL-LG	Gray	rockX
C7NL-O	Orange	rockX
C7NL-R	Red	rockX





## Kong Bent Gate L Paddle (Aluminum)

Great tool holder for chainsaw, extra length on your lanyard, holding your water bottle or cabling drill on your harness. Bright color, keylock nose.

### SPECS + FEATURES

- Bent gate with a Keylock nose
- Non-Locking
- Gate: 7 kN
- MBS: Width 22 kN; Height 8 kN
- Weight: 2.8 oz

SKU	ATTRIBUTE	PRODUCT
KNG265		Bent Gate L Paddle Aluminum Carabiner



## Kong Oval Straight Gate Non-Locking (Aluminum)

Oval carabiner with a circular section which makes it recommended for use with devices.

### SPECS + FEATURES

- Keylock system that prevents any snagging.
- MBS: 27 kN
- Anodized body and gate

SKU	ATTRIBUTE	PRODUCT
710RN0400KK		Oval Straight Gate Non-Locking Carabiner



## Edelrid Pure Slider Carabiner

Edelrid's Pure Carabiner has a locking slide-gate mechanism minimizes risk of accidental gate opening. H-profile construction ensures best possible use of material and minimal weight.

### SPECS + FEATURES

- Weight: 42 g
- Dimensions: 100 mm x 58 mm
- Gate opening: 18 mm
- Load carrying capacity: 23 kN
- Load capacity transversal: 8 kN
- Load capacity open: 8 kN
- Certification: EN 362, EN 12275

SKU	ATTRIBUTE	PRODUCT
720020001380	Oasis	Pure Slider Carabiner
720020003290	Icemint	Pure Slider Carabiner
720020006630	Slate	Pure Slider Carabiner



# snaps

## Rock Exotica SwivaEye Auto-Lock Carabiner

rock exotica

### SPECS + FEATURES

- Autolock use our ergonomic pull-down and twist mechanism.
- Utilizing high quality ball-bearings, the SwivaEye is designed for high-speed rotations with the lowest possible friction.
- MBS: 30 kN; Minor axis: 7 kN; Open gate: 12 kN
- Weight: 5.5 oz (153 gm)

SKU	ATTRIBUTE	PRODUCT
C82 A	Black	SwivaEye Auto-Lock Carabiner



## Rock Exotica Omni-Block 1.1" SwivaBiner

rock exotica

### SPECS + FEATURES

- Combines a swiveling carabiner and pulley into one tool.
- Unique sideplate that opens while the pulley is still attached to the anchor.
- Rope Size: 0.5" (13 mm)
- MBS: 23kN
- Weight: 4.9 oz (140 gm)

SKU	ATTRIBUTE	PRODUCT
P54 SB-B	Black	Omni-Block 1.1" SwivaBiner



## US Rigging Steel Double Lock Rope Snap

U.S. RIGGING SUPPLY

### SPECS + FEATURES

- A classic rope snap and USR made this snap with safety in mind.
- This ANSI certified snap hook is perfect for fall protection when you need it most.
- The Double Action Steel Double Lock Snap Hook is made from high tensile forged steel and a yellow / silver zinc plate finish.
- MBS: 23 kN

SKU	ATTRIBUTE	PRODUCT
USR01CFE	Bronze	Steel Double Lock Rope Snap



## US Rigging Aluminum Rope Snap - Double Lock

U.S. RIGGING SUPPLY

### SPECS + FEATURES

- Large design, easy to find on your lanyard.
- MBS: 6069 lbs
- WLL: 606 lbs
- Length: 5.9"
- Gate opening: 7/8" (22 mm)

SKU	ATTRIBUTE	PRODUCT
USR40	Red	Aluminum Rope Snap - Double Lock



## US Rigging Triple Lock Carabiner with Captive Eye

U.S. RIGGING SUPPLY

### SPECS + FEATURES

- MBS: 6,200 lbs | 28 kN
- Dimensions: 140 mm x 79 mm
- Weight: 3.7 oz (105 g)

SKU	ATTRIBUTE	PRODUCT
USR140		ProClimb Snap Hook Carabiner







## US Rigging ProClimb Swivel Eye Carabiner

### SPECS + FEATURES

- Tensile Strength: 5,600 lbs | 25 kN
- Dimensions: 180 mm x 76 mm
- No-Snag Gate™
- Weight: 6.0 oz (215g)

SKU	ATTRIBUTE	PRODUCT
USR221		ProClimb Swivel Eye Carabiner



## ISC Double Action Saphook (Aluminum)

The SH901 Saphook has a Safety Heel to help reduce the risk of accidental opening. This Saphook also has a 'Blind' nose design, to minimize rope snagging.

### SPECS + FEATURES

- MBS: 6070 lbs | 27 kN
- Gate Opening: 22 mm
- Eye Diameter: 20 mm
- Weight: 102 g | 3 oz

SKU	ATTRIBUTE	PRODUCT
SH901A	Gray/Red	Rope Snap Double-Action



ISC  
SOLUTIONS IN METAL

## ISC Triple Action Saphook (Aluminum)

Fitted with a third action catch for increased safety. Ideally suited to climbing activities where Triple action connectors are required. Safety Heel further reduces the risk of accidental opening and the Blind nose helps to prevent rope snagging.

### SPECS + FEATURES

- MBN: 27 kN
- Gate opening: 23 mm
- Weight: 128 g

SKU	ATTRIBUTE	PRODUCT
SH903A	Gray/Red	Rope Snap Triple-Action



ISC  
SOLUTIONS IN METAL

## ISC Triple Action Swivel Saphook (Aluminum)

Triple-action gate with a smooth swivel eye snap which eliminates twisting and tangling of your line. A great choice for flielines and lanyards. Blind nose design to reduce rope snagging.

### SPECS + FEATURES

- ABS: 25 kN
- Weight: 7 oz
- Gate opening: 22 mm
- CE EN 362

SKU	ATTRIBUTE	PRODUCT
SH905ASWIVEL	Gray/Red	Rope Snap Triple-Action Swivel



ISC  
SOLUTIONS IN METAL

## Kong Tango Rope Snap (Aluminum)

### SPECS + FEATURES

- Double gate safety system
- Rope snap opening
- Rear gate is protected in order to prevent accidental opening
- Weight: 130 g
- MBS: Major axis: 33 kN; Minor axis: 10 kN; Gate opening: 15 kN

SKU	ATTRIBUTE	PRODUCT
KNG715	Red	Tango Rope Snap



KONG  
ROPE SNAPS

# swivels + pulleys

## ISC Phlotich Pulley (Aluminum)

A multi-aperture device specifically designed for SRT and DdRT.



### SPECS + FEATURES

- Profiled side plates capture the climbing line to reduce rope movement
- Perfectly parallel side plates allow for a clean carabiner connection and are perfect for a double Rope Wrench tether
- The unique kidney-shaped opening allows carabiners to self-center according to where the load is applied.
- Large enough for carabiners to rotate completely through and for attaching multiple carabiners.
- Available with bushings or bearings.
- Rope diameter: Max 13 mm | 1/2"
- MBS: 30 kN | 6744 lbs
- Weight: 145 g | 5 oz



SKU	ATTRIBUTE	PRODUCT
RP282B1-BS	Black	13 mm Phlotich Pulley
RP282F1-BS	Gold	13 mm Phlotich Pulley
RP282E1-BS	Gray	13 mm Phlotich Pulley
RP282D1-BS	Orange	13 mm Phlotich Pulley
RP282C1-BS	Purple	13 mm Phlotich Pulley
RP282A1-BS	Red	13 mm Phlotich Pulley

## ISC Rope Wrench Pulley (Aluminum)

Pairs with **ISC Rope Wrench**. Inspected/proof tested; individual numbering



### SPECS + FEATURES

- Mobile Sideplates
- Dimensions: 74 x 45 mm
- Weight: 79 g
- Cheek Action: Swing
- MBS: 36 kN
- Approved Standard: CE EN12278



SKU	ATTRIBUTE	PRODUCT
RP281A1	Red	13 mm Rope Wrench Pulley

## Rock Exotica HYDRA Triple Swivel P4

The **HYDRA** is a triple attachment pulley which features a swivel-top connection to facilitate the pulley's use on the saddle bridge, and for use in climbing systems. Rubber o-rings line the connection points to assist in holding carabiners tightly to avoid dangerous cross-loading.



### SPECS + FEATURES

- MBS: 2 x 14 kN = 28 kN
- WLL: 2 x 2.5 kN = 5 kN
- Max Rope: 13 mm
- Sheave Diameter: 2.1" | 53 mm
- Certification: CE
- Weight: 20 oz (575 g)



SKU	ATTRIBUTE	PRODUCT
P4	Gold/Gray	13 mm HYDRA Triple Swivel P4



## DMM Pinto Pulleys

**DMM Pinto Pulleys** have a hot forged frame 7075 T6 aluminum for exceptional strength to weight ratio. The **Pinto Rig (Purple) (Large) Rigging Pulley** carries 6000-2RS series ball bearings. The **Red (small) Pinto pulley** carries an oilite bushing.

### SPECS + FEATURES

- Size of attachment holes reduce probability of locking carabiner rotation.
- Compatible with DMM Ultra O and Boa carabiners.
- Small max rope diameter: <14 mm; MBS: 40 kN (9000 lbs); Working Load Limit: 8 kN (1800 lbs); Efficiency: 71%
- Large max rope diameter 16 mm; MBS: 50 kN (11,000 lbs); Working Load Limit: 10 kN (2200 lbs); Efficiency: 95%

SKU	ATTRIBUTE	PRODUCT
PUL110	Red	Pinto Pulley Red (Small)
PUL120	Purple	Pinto Rig (Purple) (Large) Rigging Pulley



## DMM Pinto Pulley Spacers

**DMM Pinto Pulley Spacers** are an essential component for Pinto and Pinto Rig applications where textile connecting elements tend to compress the side plates.

### SPECS + FEATURES

- Small for Pinto Pulley or Large for Pinto Rig Pulley

SKU	ATTRIBUTE	PRODUCT
PUL110SPA	Red	Pinto Pulley Spacer (Small)
PUL120SPA	Red	Pinto Pulley Spacer (Large)



## DMM Hitch Climber Triple Attachment Pulley

The **DMM Triple Attachment Pulley** (Hitch Climber Pulley) combines the high efficiency of our pulleys with a small three hole rigging plate to give an extremely versatile piece of equipment.

### SPECS + FEATURES

- MBS: 30 kN
- WLL: 7 kN
- Max Rope Size: 14 mm
- Dimensions: 94 x 68 x 33 mm
- Weight: 133 g
- Certified to EN12278:2007 (Pulleys) and NFPA 1983 (2012 Edition) Class T rating; Anodized to BS EN 7599:2010 AA10 Sealed for corrosion protection

SKU	ATTRIBUTE	PRODUCT
PUL100	Red	13 mm Triple Attachment Pulley



## DMM Hitch Climber Eccentric Pulley

The new geometry of the **Eccentric Pulley** offers greater efficiency combined with a striking aesthetic. The 'pushing plates' will advance your friction hitch earlier and the optimized fairlead flairs direct rope towards the sheave when tending slack. Also features a large sheave with an efficient roller bearing and a stainless steel axle.

### SPECS + FEATURES

- MBS: 30 kN
- WLL: 6 kN
- Max Rope Size: 14 mm
- Dimensions: 96 x 66 x 44 mm
- Weight: 176 g

SKU	ATTRIBUTE	PRODUCT
PUL500	Red	13 mm Hitch Climber Eccentric Pulley



# swivels + pulleys

CLIMBING / SWIVELS + PULLEYS

## CMI Micro Pulley

*CMI*

**CMI's RP110 Micro Pulley** is primarily used as a slack tender for your friction hitch on a traditional system or on your lanyard. The sideplates swing open to allow placement anywhere on the line. The aluminum cheeks plates designed to work with a carabiner has a 7/8" hole. A double lock nut holds everything together on an stainless steel axle and 1 1/4" Aluminum sheave bushing.

### SPECS + FEATURES

- MBS: 7,000 lbs
- WLL: 700 lbs
- Rope capacity: 1/2"
- Dimensions: 2.75" x 1.85"
- Weight: 0.15 lb

SKU	ATTRIBUTE	PRODUCT
RP110	Purple	Micro Pulley

REFER TO  
PAGE 230 FOR  
THE RP110D



## CMI Micro Mouse Pulley

*CMI*

Ideal for Arborist rigging where two independent tie-ins are required.

### SPECS + FEATURES

- Purple Anodized Aluminum sideplates
- 1 1/4" Aluminum sheave
- Bushing and Stainless Steel axle
- MBS: 7,000 lbs
- WLL: 700 lbs
- Rope Capacity: 1/2"
- Dimensions: 2.75" x 2.8"
- Weight: 0.2 lb

SKU	ATTRIBUTE	PRODUCT
RP141	Purple	13 mm Micro Mouse Pulley



## CMI Stainless Steel Shackle Pulley

*CMI*

The **CMI RP144 Shackle Pulley** is both strong and compact. Weighing only 3 oz and it's among the smallest load-bearing pulleys available to our field.

### SPECS + FEATURES

- Stainless Steel sideplates, 1.25" Aluminum sheave
- Bushing and Stainless Steel axle
- MBS: 8,000 lbs
- Rope Capacity: 1/2"
- Weight: 0.16 lbs

SKU	ATTRIBUTE	PRODUCT
RP144	Stainless	Stainless Steel Shackle Pulley



Photo by MLI,  
Certified Arborist





## DMM Axis Swivels

**DMM Axis Swivels** have been designed to be smooth, compact and incredibly strong. Made from hot forged, CNC machined bodies from heat treated, 7075 T6 aluminum alloy, with large bearings and heat treated, stainless steel axles.

### SPECS + FEATURES

- SW100 - Small accommodates 2 carabiners snugly  
Strength: 36 kN; Dimensions: 79 x 50 x 33 mm; Weight: 115 g
- SW200 - Large more spacious for larger connectors  
Strength: 50 kN; Dimensions: 96 x 60 x 39 mm; Weight: 184 g
- BS EN 7599:2010 AA10; EN 795(b): 2012 and EN354:2010; NFPA 1983 (2012 ED) Class G

SKU	ATTRIBUTE	PRODUCT
SW100	Small	Axis Swivels (Blue)
SW200	Large	Axis Swivels (Red)



## DMM Mini Swivel

The **DMM Mini Swivel** is a compact, hot-forged swivel designed for use at junctions where torsion needs management. A high-quality internal bearing ensures smooth and reliable rotation, while the textile-friendly connection points are perfect for one carabiner or cordage. All the benefits of a swivel without any bulk.

### SPECS + FEATURES

- Fits in the palm of your hand extremely lightweight
- Dimensions: 65 x 31 x 21 mm; Interior Diameter: 16 mm x 15.64 mm
- MBS: 26 kN; WLL: 3 kN
- Weight: 47 g

SKU	ATTRIBUTE	PRODUCT
SW400		Mini Swivel



## Rock Exotica Shackle Swivel

The **Shackle Swivel** saves valuable headspace by allowing you to connect webbing, eyes or thimbles directly to the swivel without a carabiner. The steel shackle bolt increases the longevity of the swivel when connected to other steel components.

### SPECS + FEATURES

- Shackle Bolt Diameter: .375" | 9.5mm
- Weight: 5.7 oz

SKU	ATTRIBUTE	PRODUCT
SS1		Shackle Swivel



## US Rigging Double Swivel

### SPECS + FEATURES

- Dimensions: 108 mm x 61 mm
- Tensile Strength: 8,990 lbs | 40 kN
- Weight: 5.5 oz | 156 g

SKU	ATTRIBUTE	PRODUCT
USRDSL		Double Swivel



# lanyards

## US Rigging Adjustable Safety Lanyards

Constructed from three strand polyester or double braided polyester/nylon line. A non-complicated basic lanyard. A solid secondary tool for safety while tied in using climbing spurs.

### SPECS + FEATURES

- Forged alloy steel, double locking safety snap hooks tested and rated at 23 kN (5,000 lbs)
- 1/2" diameter
- Length: 4-7'
- Hand spliced eyes
- Shrink tubing forms tapered cover over tails

SKU	ATTRIBUTE	PRODUCT
LYB1607	polyester	Adjustable Lanyard 3 Strand
LYT1607	polyester/nylon	Adjustable Lanyard Double Braid



## US Rigging Two-In-One Adjustable Lanyard

A safety lanyard made of 1/2" diameter 3-strand polyester. Each connector is a double locking safety snap hook.

### SPECS + FEATURES

- Rated: 5,000 lbs and are all 100% proof load tested
- 3-Strand White Polyester Rope
- Diameter: 1/2" | 13 mm
- Steel Rope Snaps with captive eye
- English Prusik: 20"

SKU	ATTRIBUTE	PRODUCT
LYT1610	10'	Two-In-One Adjustable Lanyard



## Spyder Two-in-One Adjustable Lanyard

Constructed of 1/2" diameter 3-strand polyester line and configured as a two-in-one safety lanyard. Allows climber to be securely tied in twice, with one tool.

### SPECS + FEATURES

- Length: 1-9" adjustable 3-strand lanyard
- ABS: 5000 lbs
- Diameter: 1/2" | 13 mm
- Aluminum Rope snaps - self locking, double action snaps
- 20" Prusik

SKU	ATTRIBUTE	PRODUCT
75208	1-9"	Two-In-One Adjustable Lanyard







## Kong Trimmer Lanyard

**Kong's Trimmer Lanyard** is a new work positioning device that enables quick and accurate adjustment of length for positioning at the work station. Super smooth adjustment even under load. The **Trimmer** is the smallest and lightest length adjustment device on the market.

### SPECS + FEATURES

- It is used on the work positioning D-rings on the harness waistbelt.
- Can be used from the ventral or lateral attachment points
- Fitted with protective sheath to protect the rope from the contact points
- Visible stitchings for a quick visual inspection.

SKU	ATTRIBUTE	PRODUCT
289SETU02KK	3M	Trimmer Lanyard
289SETU04KK	5M	Trimmer Lanyard



## 3-Strand Adjustable 3-6' Lanyard

### SPECS + FEATURES

- Cordage: Teufelberger 3-strand
- Hardware: 2 x Steel rope snaps
- Adjustable prusik
- Diameter: 1/2"
- Rope Snaps: double action
- MBS: 5,000 lbs

SKU	ATTRIBUTE	PRODUCT
000184	1/2"	3-Strand Adjustable 3-6' Lanyard



CUSTOMIZED PRODUCT

## Double Braid Adjustable Lanyard

### SPECS + FEATURES

- Cordage: Samson Double Braid
- Adjustable 3-6' length
- Hardware: 2 x Steel rope snaps
- Adjustable prusik
- Rope Diameter: 1/2"
- Rope Snaps: double action
- MBS: 5,000 lbs

SKU	ATTRIBUTE	PRODUCT
000186	1/2"	Double Braid Adjustable Lanyard



CUSTOMIZED PRODUCT

## Blue Moon Lanyard ISC Double Snap To Eye

### SPECS + FEATURES

- Cordage: Yale Blue Moon
- Rope Diameter: 11.7 mm
- ISC Aluminum Double Snap, Double Action Lock SH901  
MBS: 27 kN; Gate opening: 23 mm | 0.87"
- Finished end: 1" eye splice
- Weight: 128 g | 3 oz
- MBS: 6,500 lbs

SKU	ATTRIBUTE	PRODUCT
011265	10'	Blue Moon Lanyard ISC Double Snap To Eye



CUSTOMIZED PRODUCT

# lanyards

CLIMBING / LANYARDS / LANYARDS + STRAPS

## Blue Moon Lanyard with ISC Double Locking Rope Snap-Eye

### SPECS + FEATURES

- Yale Blue Moon 24-strand 11.7 mm
- MBS: 6,500 lbs
- Hardware: ISC Aluminum Locking Rope Snap-Eye
- MBS: 27 kN
- Finished: Tight Eye splice Length: 14'

SKU	ATTRIBUTE	PRODUCT
012498	14'	Lanyard Blue Moon ISC Snap-Eye



CUSTOMIZED PRODUCT

## Blue Moon Lanyard with US Rigging Aluminum Snap-Eye

### SPECS + FEATURES

- Yale Blue Moon cordage
- ABS: 6,500 lbs
- Hardware: US Rigging Red Aluminum Rope Snap-Eye
- Finished: Tight Eye splice

SKU	ATTRIBUTE	PRODUCT
011652	10'	Blue Moon Lanyard US Rigging Aluminum Snap-Eye



CUSTOMIZED PRODUCT

## Teufelberger Tachyon Lanyard with ISC Triple Rope Snap

### SPECS + FEATURES

- Cordage: Teufelberger Tachyon (colors vary)
- Hardware: ISC Triple Black Rope Snap SH903E
- Finished with tight eye splice

SKU	ATTRIBUTE	PRODUCT
012534	12'	Tachyon Lanyard with ISC Triple
012512	16'	Tachyon Lanyard with ISC Triple



CUSTOMIZED PRODUCT

## Frostbight Tachyon Lanyard with CT Evo Snap to Tight Eye

### SPECS + FEATURES

- Cordage: Frostbight Tachyon
- Hardware: CT Evo Rope Snap
- End termination: Tight eye splice

SKU	ATTRIBUTE	PRODUCT
011745	10'	Frostbight Lanyard with CT Aluminum Snap



CUSTOMIZED PRODUCT



CUSTOMIZED  
PRODUCT

## Samson Blue Streak Lanyard with CT Blue Rope Snap to Tight Eye

### SPECS + FEATURES

- Cordage: Samson BlueStreak
- Diameter: 1/2"
- Cordage ABS: 8,100 lbs
- Hardware: ISC Blue Rope Snap
- Hardware MBS: 5,600 lbs | 25 kN
- Locking: Double action
- Finished: Tight eye splice

SKU	ATTRIBUTE	PRODUCT
012603	14'	Samson Blue Streak Lanyard



## Prusik Runner with Locking Snap

Equipped with a double-locking safety snap.

### SPECS + FEATURES

- 1/2" x 20"
- 3 strand twisted white polyester
- Double locking safety snap hook
- 100% proof load tested
- 5,000 lbs tensile strength

SKU	IN	PRODUCT
PRT16020	1/2" x 20"	Prusik Runner with Locking Snap

**PELICAN ROPE**  
The Most Trusted Name In Rope!



## Spyder Prusik Runner With Carabiner 1/2"

20" prusik line with triple locking HMS carabiner

### SPECS + FEATURES

- Cordage: 3 strand twisted white polyester
- Hardware: Auto-locking aluminum carabiner

SKU	IN	PRODUCT
75150	1/2x20"	Prusik Runner With Steel Snap

**Spyder**  
MANUFACTURING / USA



## Spyder Rope Prusik Runner with Steel Rope Snap 1/2"

20" prusik line with double locking steel snap.

### SPECS + FEATURES

- Cordage: 3 strand twisted white polyester
- Hardware: Double locking safety snap hook
- 100% proof load tested
- MBS: 5,000 lbs tensile strength

SKU	IN	PRODUCT
75130	1/2x20"	Prusik Runner With Steel Snap

**Spyder**  
MANUFACTURING / USA



## Spyder Prusik Runner with Aluminum Rope Snap 1/2"

20" prusik line with double locking aluminum snap.

### SPECS + FEATURES

- Cordage: 3 strand twisted white polyester
- Hardware: Double locking aluminum rope snap

SKU	IN	PRODUCT
75148	1/2x20"	Prusik Runner With Aluminum Snap

**Spyder**  
MANUFACTURING / USA



# lanyards

CLIMBING / LANYARDS / LANYARDS + STRAPS

## Elk River Adjustable Webbing Lanyard

Elk River, Inc.  
Personal Fall Protection

Simple and straight forward safety. Adjustable work positioning lanyard for a connection point to a pole or a tree. Adjustable web lanyard with CenturionZ snaphooks.

### SPECS + FEATURES

- Constructed from Nylon web material
- CenturionZ, double locking steel rope snap with captive eye and 3.6M Gate
- Positioning, adjustable
- Length: 1" x 6'

SKU	ATTRIBUTE	PRODUCT
29506	6'	Adjustable Webbing Lanyard



## Buck TreeSqueeze™ Adjustable Choking Lanyard System

BUCK  
1888

**Buck TreeSqueeze** is used for fall restraint and work positioning. This innovative work positioning lanyard allows for a secured ascent up the tree giving you all the safety and confidence you need when conductive tree removals with gaffs.

### SPECS + FEATURES

- TreeSqueeze integrates a choking lanyard system that keeps you from falling down the tree in the event of a Gaff out.
- Made from high strength 7/16" doubled the rope for extra rigidity, cut resistance and surface area
- The double rope specifically protects against cuts from handsaws and provides the user with a smoother ascent.
- Aluminum ring Prusik provides users with quick and easy adjustment for different diameter trees and a secure tie-in point when a natural tie in point doesn't exist
- Prusik is key for easy descent, self-rescue and even doubles as a friction saver.
- Overall Length: 8'
- Contains Red Wear Center
- Weight: 1.10 lbs.
- User Weight Capacity: 350 lbs

SKU	ATTRIBUTE	PRODUCT
7L08T18J		TreeSqueeze

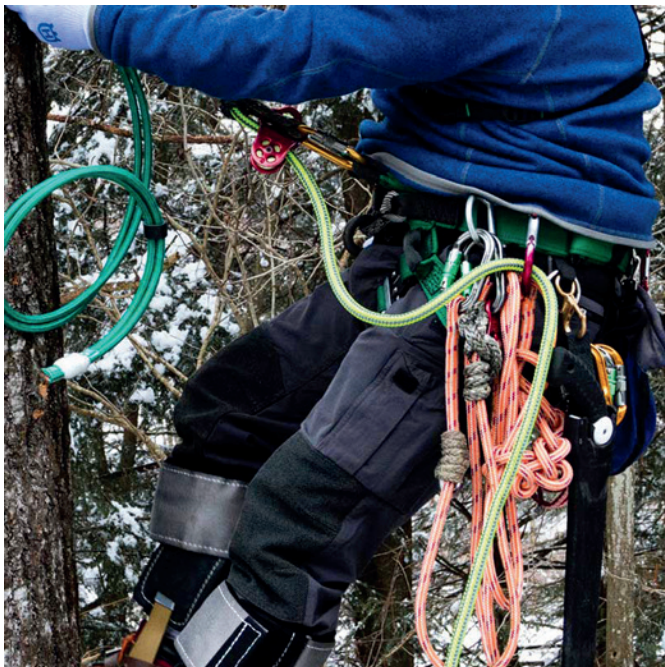





## US Rigging Polyester Flipline Lanyard

### SPECS + FEATURES

- 16-strand polyester double braid
- Hand spliced thimble eye on other end
- Double locking forged steel snap on one end
- Safety Steel Snap rated 5,000 lbs tensile strength
- Make a complete lanyard and pair with a 1/2" rope grab

SKU	ATTRIBUTE	PRODUCT
FL1608	8'	Polyester Core Lanyard
FL1610	10'	Polyester Core Lanyard
FL1612	12'	Polyester Core Lanyard



## Sterling TriTech Flipline Lanyard



**Sterling's TriTech Flipline Lanyard** features their own unique Technora sheath, Dyneema inner jacket and nylon core. A great alternative to a wirecore line; TriTech offers the best cut resistance with non-conductive properties.

### SPECS + FEATURES

- 11 mm Nylon Core/Technora & Spectra Sheath
- Hardware: CT Steel Rope Snap
- Splice: Sewn Eye
- Certs: Meets ANSI Z133.1
- MBS: 5418 lbs | 24.1 kN

SKU	ATTRIBUTE	PRODUCT
SCTFLSS10	10'	TriTech Flipline Lanyard
SCTFLSS12	12'	TriTech Flipline Lanyard



## Yale Maxi-Flip Sport Flipline



**Yale Maxi-Flip Sport Flipline** wire core flip lines have Free Flex end terminations to minimize the in-use wire rope axial fatigue. This provides the climber with the safest possible end termination. Available with an aluminum ISC swivel snap on one end and terminated with a thimble eye.

### SPECS + FEATURES

- 16-strand cover, 1/2" diameter and coated with Maxijacket red to maximize abrasion resistance
- 25% lighter than the standard Maxi-Flip
- Free Flex Flemish eye splice
- CE approved EN358

SKU	ATTRIBUTE	PRODUCT
93532A4010XB	10'	Maxi-Flip Sport Flipline



## US Rigging Wire Core Lanyard (Flipline) Kit



### SPECS + FEATURES

- Wire Core lanyard kits with double locking swivel snap
- 16-strand polyester composite over a galvanized steel aircraft cable
- Polyester Cover over Flexible 1/4" - 7x19 Wire Rope
- Bright neon orange with urethane coating for extra abrasion resistance
- Safety rope snap & thimble eye ends

SKU	ATTRIBUTE	PRODUCT
FLA1608	8'	Wire Core Flipline 1/2"
FLA1610	10'	Wire Core Flipline 1/2"
FLA1612	12'	Wire Core Flipline 1/2"
FLA2008SE-CS07	8'	Wire Core Flipline 5/8"
FLA2010SE-CS07	10'	Wire Core Flipline 5/8"
FLA2012SE-CS07	12'	Wire Core Flipline 5/8"



# lanyards

CLIMBING / LANYARDS / FLIPLINES

## US Rigging Steel Core Flipline 1/2" Kit

High visibility wire core flipline kit complete with double locking swivel snap, rope grab positioner and autolocking carabiner



### INCLUDES

- Rope grab positioner
- Auto Locking Copperhead Carabiner (USR128)
- 16-strand polyester composite over a galvanized steel aircraft cable
- Galvanized thimbles at each end with a doublelocking swivel snap at one end

SKU	ATTRIBUTE	PRODUCT
FLK1208	8'	Steel Core Flipline 1/2" Kit
FLK1210	10'	Steel Core Flipline 1/2" Kit
FLK1212	12'	Steel Core Flipline 1/2" Kit



Not for use around electric lines.

## Spyder Steel Wire Core Lanyard (Flipline)



### INCLUDES

- 1 wire core lanyard
- 1 rope grab - fixed pin
- 1 HMS triple lock carabiner
- 1 steel large swivel snap

SKU	ATTRIBUTE	PRODUCT
75221	8'	Steel Wire Core Lanyard (Flipline) 1/2" Kit
75222	10'	Steel Wire Core Lanyard (Flipline) 1/2" Kit
75223	12'	Steel Wire Core Lanyard (Flipline) 1/2" Kit
75241	8'	Steel Wire Core Lanyard (Flipline) 5/8" Kit
75242	10'	Steel Wire Core Lanyard (Flipline) 5/8" Kit
75243	12'	Steel Wire Core Lanyard (Flipline) 5/8" Kit



Not for use around electric lines.

## Spyder Steel Wire Core Lanyard (Flipline) 1/2" Kit



### INCLUDES

- 1 wire core lanyard
- 1 rope grab - fixed pin
- 1 HMS triple lock carabiner
- 1 US Rigging aluminum swivel snap

SKU	ATTRIBUTE	PRODUCT
75191	8'	Steel Wire Core Lanyard (Flipline) 1/2" Kit
75192	10'	Steel Wire Core Lanyard (Flipline) 1/2" Kit
75193	12'	Steel Wire Core Lanyard (Flipline) 1/2" Kit



Not for use around electric lines.

## Sterling Ultimate Positioning Lanyard



Sterling's all in one positioning lanyard kit comes prepared to handle multiple work and connection options. Built around **Sterling's TriTech flipline**. TriTech construction features durable Technora sheath over a unique inner Dyneema jacket covering a nylon core. These fibers combine to provide a rope lanyard that protects you against accidental nicks that could seriously compromise any other rope lanyard.

### SPECS + FEATURES

- The UP Lanyard is designed to function as a true work positioning system.
- Multiple work and connection options allow for two-in-one positioning, one handed operation of tending slack, "M" system configuration or as a single leg up off a bridge.
- TriTech rope offers the best abrasion resistance and nonconductive properties.

SKU	ATTRIBUTE	PRODUCT
KTUPLAN12	12'	Ultimate Positioning Lanyard







## Teufelberger hipSTAR FLEX Lanyard (formerly CE Lanyard)

Arborists from all around the world are using the CE lanyard and enjoying the advantages of this unique system. Our CE lanyard becomes **hipSTAR FLEX!**

### SPECS + FEATURES

- Length: 3m, 4m, 5m, (7m, 10m by special order)
- Standards: EN 358:1999; EN 795B:2012; AS/NZS 5532:2013; AS/NZS 1891.1:2007; ANSI Z133-2017
- Replacement parts/Enhancements: Ocean Polyester e2e; Ocean Dyneema Loop T; CE lanyard e2e

SKU	ATTRIBUTE	PRODUCT
7351121	4 M	11.5 mm Hipstar Flex Lanyard
7350090	5 M	11.5 mm Hipstar Flex Lanyard
7351123	7 M	11.5 mm Hipstar Flex Lanyard
7351124	10 M	11.5 mm Hipstar Flex Lanyard
7350095	5 M	11.7 mm Hipstar Lanyard Replacement



## Frostbight Lanyard Kit

For the arborist who wants something lightweight and adjustable with one hand.

### INCLUDES

- 10' of Frostbight Tachyon 11.5 mm
- 2 - Tight eye splices
- 1 - Rock Exotica Oval carabiner
- 1 - DMM Shadow carabiner
- 1 - HRC hitch cord tied with Knut friction hitch
- 1 - Shizll hitch advancer

SKU	ATTRIBUTE	PRODUCT
010685	10'	Frostbight Lanyard Kit



CUSTOMIZED PRODUCT

## Teufelberger DMM Ocean Polyester Thimble Loop

This **Ocean Polyester** sewn loop is a replacement component for the Teufelberger **fimbISAVER**.

### SPECS + FEATURES

- DMM 8mm stainless steel thimble with tab (8 mm x 38cm)
- DMM 7mm stainless steel thimble no tab (7mm)

SKU	ATTRIBUTE	PRODUCT
7350606	7 mm	DMM Thimble Loop
7350841	8 mm	DMM Thimble Loop



## Sterling RIT Thimble Prusik 8 mm

This unique prusik uses **RIT 500™** construction with a Twaron® sheath and nylon core for excellent heat and abrasion resistance.

### SPECS + FEATURES

- Steel thimble offers a clean connection point
- Provides numerous options for adjustable anchors or connections
- MBS: 24.1 kN (5,418 lbs)
- Meets ANSI Z133

SKU	ATTRIBUTE	PRODUCT
SC08ATP013	8 mm	RIT Thimble Prusik



# lanyards

CLIMBING / LANYARDS / ROPE GRABS

## Gibbs Klimair Arborist Rope Grab – 1/2"

### SPECS + FEATURES

- Two-in-one lanyards with dual rope snaps or carabiners
- Bi-directional; cannot adjust under load
- Great for one handed adjustment to taking up your slack on your lanyard
- Can also be used for ascending and rigging applications
- Not for self belay
- Rope diameter: 11 mm - 13 mm (7/16 - 1/2")
- Materials: 0.160 aluminum shell with stainless steel swivel eye
- MBS: 5,000 lbs
- Weight: 5.5 oz

SKU	ATTRIBUTE	PRODUCT
KLIMAIR		Klimair



## Gibbs Rope Grabs

### SPECS + FEATURES

- Great for wire core lanyards where one hand adjustable is key
- Spring Loaded Forged Cam
- For litter raising/load hauling, where extra strength is required. Not for self belay.
- 3/16" Aluminum Shell – Capacity: 7/16" to 1/2" (11 mm to 13 mm) Rope  
MBS: 5,000 lbs
- 3/16" Stainless Steel Shell – Capacity: 5/8" to 3/4" (14 mm to 19 mm) Rope  
MBS: 5,650 lbs

SKU	ATTRIBUTE	PRODUCT
G3A	Alum	Gibbs Rope Grab Push Pin 7/16-1/2
G3AB	Alum	Gibbs Rope Grab Bolt 7/16-1/2
G4A	Alum	Gibbs Rope Grab Push Pin 5/8-3/4
G4AB	Alum	Gibbs Rope Grab Bolt 5/8-3/4
G3S	Steel	Gibbs Rope Grab Push Pin 7/16-1/2
G3SB	Steel	Gibbs Rope Grab Bolt 7/16-1/2
G4S	Steel	Gibbs Rope Grab Push Pin 5/8-3/4
G4SB	Steel	Gibbs Rope Grab Bolt 5/8-3/4



## ART Positioner with Swivel

ART's compact and lightweight rope grab device performs more smoothly than traditional cam style rope grabs. Made of aluminum alloy and stainless steel pins.

### SPECS + FEATURES

- German-engineered Positioner with an ingenious clutch mechanism that provides users with feathered tension release while under load
- Hole for carabiner connection point
- For left or right handed people
- Compatible with 11-13 mm diameter lines
- Replaceable clutch

SKU	ATTRIBUTE	PRODUCT
29454S		Positioner 2 w/Swivel



## Shizll® Rope Slider

### SPECS + FEATURES

- Advantages over a pulley: Easy to use, No moving parts, No additional friction when climbing a different angle than straight up or down, Reduces twists
- Can be used in your lanyard and in your climbing system.
- Great affordable alternative to a micro-pulley.

SKU	COLOR	PRODUCT
R01	Varies	Rope Slider



FOR YOUR "FIGHTER WEIGHT" LANYARD!

Not load bearing and not made to hang on. Not Personal Protection Equipment (PPE).



## Rock Exotica Rock Grab

In **Rock Exotica's** style, this sleek design offers climbers a light and strong rope grab. Streamlined and orientated where your carabiner sits more naturally when one-handed positioning. Not for vertical ascent.

### SPECS + FEATURES

- Not adjustable under tension
- Requires tool to remove from lanyard; great safety feature
- Weight: RG2: 5.6 oz or RG4: 8.8 oz

SKU	ATTRIBUTE	PRODUCT
RG2-90	9-13 mm	Rock Grab
RG4-90	13.5-16 mm	Rock Grab



## Spyder Climb Right Rope Grab – Fixed Pin

It's made in the U.S.A. and it's compact and lightweight, plus it works with both 1/2" and 5/8" flielines. It has an internal spring design that is both stronger and more reliable than traditional springs. And the price is really something to smile at when you compare this rope grab to its competition.

### SPECS + FEATURES

- Made from high-quality aircraft grade aluminum
- The Nyloc nut design provides double thread locking security--the pin threads into the rope grab body, and then the Nyloc nut is fastened, making for an extra secure design
- Replacement parts are available
- Rope Capacity: 1/2" - 5/8" (12-15 mm) or Micro: 3/8 -1/2" (10-12 mm)
- Weight: 7.5 oz

SKU	ATTRIBUTE	PRODUCT
85528	3/8 -1/2"	Climb Right Gibbs Rope Grab – Fixed Pin
85568	1/2" - 5/8"	Climb Right Gibbs Rope Grab – Fixed Pin



## US Rigging ProClimb Mini

### SPECS + FEATURES

- Fits 7/16" - 5/8" Flip Lines
- Fixed Bolt & Nut
- Aluminum Alloy
- Hard Anodized
- Removable Cam

SKU	ATTRIBUTE	PRODUCT
MRG200		ProClimb Aluminum Mini Rope Grab



## Kong Duck Rope Grab

**Duck**, the innovative emergency rope clamp. Conceived for single ropes with a diameter between 8 and 13 mm, is the first and only clamp that also works on flat and tubular slings from 10 to 15 mm width (even if these are not certified for progression).

### SPECS + FEATURES

- Due to its small dimensions, it can be easily attached with one hand.
- Big hole allows locking connectors to rotate. Born as an emergency rope clamp for retrieval, progression maneuvers and for the regulation of daisy chains.
- Weight: 70 g | 0.15 oz
- Height: 20.5"; Length: 2.4"; Width: 1"
- Rope or Webbing Capacity: 10-15 mm

SKU	ATTRIBUTE	PRODUCT
88800NG00KK		Duck Rope Grab



# prusiks + split tails

## Teufelberger epiCORD - Prusik 11/32" | 9.3 mm

### SPECS + FEATURES

- Cover composed of polyester and Technora® which yields a tight cover that gives you the necessary heat resistance but at the same time flexible enough to easily tie your hitch.
- Core of epiCORD is a combination of Technora and Dyneema® braided for strength and performance.

SKU	IN	PRODUCT
C2413-09-00300	BULK	epiCORD - 11/32"   9.3 mm
3235284	28"	epiCORD - 11/32"   9.3 mm
3235304	30"	epiCORD - 11/32"   9.3 mm



## Teufelberger epiCORD - Prusik 3/8" | 10 mm

### SPECS + FEATURES

- Cover composed of polyester and Technora® which yields a tight cover that gives you the necessary heat resistance but at the same time flexible enough to easily tie your hitch.
- Core of epiCORD is a combination of Technora and Dyneema® braided for strength and performance.

SKU	IN	PRODUCT
3236284	28"	epiCORD - 3/8"   10 mm



## Donaghys Armor-Prus Poly - Prusik 5/16" | 8 mm

### SPECS + FEATURES

- Unique cover blend of Technora and Polyester that acts like Armor over a core of light weight Spectra® 900/Kevlar.
- Long lasting, heat resistant
- Pairs great with 7/16" | 11mm lines

SKU	IN	PRODUCT
3413284 SEWN	28"	Armor-Prus Orange - 5/16   8 mm
3413304 SEWN	30"	Armor-Prus Orange - 5/16   8 mm
3411284 SEWN	28"	Armor-Prus Green - 5/16   8 mm
3411304 SEWN	30"	Armor-Prus Green - 5/16   8 mm
3411404 SEWN	40"	Armor-Prus Green - 5/16   8 mm



## Donaghys Armor-Prus Poly - Prusik 3/8" | 10 mm

### SPECS + FEATURES

- Unique cover blend of Technora and Polyester that acts like Armor over a core of light weight Spectra® 900/Kevlar.
- Long lasting, heat resistant
- Pairs great with 7/16" | 11mm lines

SKU	IN	PRODUCT
3412284	28"	Armor-Prus Poly Eye /Eye Hitch Cord - 3/8   10 mm
3412304	30"	Armor-Prus Poly Eye /Eye Hitch Cord - 3/8   10 mm
3412324	32"	Armor-Prus Poly Eye /Eye Hitch Cord - 3/8   10 mm





## Teufelberger HRC ThermaShield – Prusik 5/16" | 8 mm

### SPECS + FEATURES

- Extremely heat resistant cover made of Technora and spun Nomex. Nomex and Technora cover over a Vectran core. Good for friction hitches with great heat resistance.
- Great hand; supple with an excellent grip
- Non-melting; Non-glazing

SKU	IN	PRODUCT
3231284	28"	HRCThermaShield – 5/16"   8mm
3231304	30"	HRCThermaShield – 5/16"   8mm
3231324	32"	HRCThermaShield – 5/16"   8mm
HRC 5/16X30	30"	HRCThermaShield –Spliced – 5/16"   8mm



## Yale Bee-Line – Prusik 3/8" | 10 mm

### SPECS + FEATURES

- First rope designed to wick the heat of friction away from a knot.
- Technora Aramid fiber has heat resistance through 800 degrees F and excellent cut resistance.
- Vectran, Technora/polyester cover

SKU	IN	PRODUCT
3352284	28"	Bee-Line – 3/8"   10 mm
3352304	30"	Bee-Line – 3/8"   10 mm



## Sterling Flex – Prusik 5/16" | 8 mm

### SPECS + FEATURES

- Ultra-strong and water-resistant polyester fibers surrounded by a blended Technora®/polyester sheath.
- Cover provides solid abrasion resistance with enough bite to hitch firmly onto ropes.

SKU	IN	PRODUCT
3523284	28"	Flex – 5/16"   8 mm
3523304	30"	Flex – 5/16"   8 mm
3523324	32"	Flex – 5/16"   8 mm



## Sterling Flex – Prusik 3/8" | 10 mm

### SPECS + FEATURES

- Ultra-strong and water-resistant polyester fibers surrounded by a blended Technora®/polyester sheath.
- Cover provides solid abrasion resistance with enough bite to hitch firmly onto ropes.

SKU	IN	PRODUCT
SC10AP2E028	28"	Flex – 3/8"   10 mm
SC10AP2E030	30"	Flex – 3/8"   10 mm
SC10AP2E032	32"	Flex – 3/8"   10 mm



# prusiks + split tails

CLIMBING / PRUSIKS + SPLIT TAILS

## Sterling RIT – Prusik 5/16" | 8 mm

### SPECS + FEATURES

- Provides consistent friction in a wide variety of situation thanks to their firmer, tight Twaron sheaths.
- Made from our RIT 500 cord which provides a firm feel and solid durability.

SKU	IN	PRODUCT
SC08AN2E028	28"	RIT – 5/16"   8 mm
SC08AN2E030	30"	RIT – 5/16"   8 mm
SC08AN2E032	32"	RIT – 5/16"   8 mm



**STERLING**

## Sterling RIT – Prusik 3/8" | 9 mm

### SPECS + FEATURES

- Provides consistent friction in a wide variety of situation thanks to their firmer, tight Twaron sheaths.

SKU	IN	PRODUCT
SC09AP2E030	30"	RIT Rescue – 3/8"   9 mm



**STERLING**

## Samson Ice Tail – Prusik 5/16" | 8 mm

### SPECS + FEATURES

- A single carrier 12-strand hollow braid that has a great hand and a soft feel.
- With excellent grip and high heat-resistance because of the Aramid fibers Ice Tail is a popular choice as a friction hitch cord in climbing systems.

SKU	IN	PRODUCT
ICETAIL5/16X28	28"	Ice Tail – 5/16"   8 mm
ICETAIL5/16X30	30"	Ice Tail – 5/16"   8 mm
ICETAIL5/16X32	32"	Ice Tail – 5/16"   8 mm
ICETAIL5/16X36	36"	Ice Tail – 5/16"   8 mm



**samson**  
THE STRONGEST NAME IN ROPE

## Samson Bail Out-XL – Prusik 3/8" | 9 mm

### SPECS + FEATURES

- Bail Out is a Double-Braid prusik cord that has a firm feel.
- It is incredibly durable and long lasting
- It offers the ultimate in heat resistance – it will not melt or flatten out.

SKU	IN	PRODUCT
012739	BULK	Bail Out-XL – 3/8"   9 mm



**samson**  
THE STRONGEST NAME IN ROPE

## Teufelberger Ocean Polyester – Prusik 5/16" | 8 mm

### SPECS + FEATURES

- Highly abrasion resistant and Heat resistant
- Good grippyness
- Thanks to its long service life, the Ocean Polyester is great value for your money.

SKU	IN	PRODUCT
7350808	33.5"	Ocean Polyester – 5/16"   8 mm



**Teufelberger**  
Together in Motion

## Teufelberger Ocean Polyester – Prusik 3/8" 10mm

### SPECS + FEATURES

- Highly abrasion resistant and Heat resistant
- Good grippyness
- Thanks to its long service life, the Ocean Polyester is great value for your money.

SKU	IN	PRODUCT
7351007	25.5"	Ocean Polyester – 3/8"   10 mm
7351011	33.5"	Ocean Polyester – 3/8"   10 mm



**Teufelberger**  
Together in Motion



## Samson Tenex Tec – Prusik 3/8" | 9.5 mm

### SPECS + FEATURES

- High-strength, low-stretch rope designed with two ends per carrier allowing for more rope surface conformance to objects being lifted than standard single braid
- Samthane coated to enhance wear life.

SKU	IN	PRODUCT
3/8X24TENEX	24"	Tenex-TEC – 3/8"   9.5 mm
3/8X30TENEX	30"	Tenex-TEC – 3/8"   9.5 mm



## Beeline Sewn – Prusik 5/16" | 8 mm

### SPECS + FEATURES

- Machine sewn eye on each tail sewn by Pelican Rope
- A high quality polyester cord that is soft and flexible with great gripping ability.
- Tough kernmantle technora jacket over polyester core.

SKU	IN	PRODUCT
EE28	28"	Bee-Line – 5/16"   8 mm
EE30	30"	Bee-Line – 5/16"   8 mm
EE32	32"	Bee-Line – 5/16"   8 mm



## Spyder Sewn Prusik 8 mm | 5/16"

Fast action eye and eye hitch cord. Great for DRS|SRS systems.

### SPECS + FEATURES

- Constructed with a Technora outer sheath which is chemical, flame and wear resistant

SKU	IN	PRODUCT
36520	28"	Sewn Prusik 8 mm   5/16"
36521	30"	Sewn Prusik 8 mm   5/16"
36522	32"	Sewn Prusik 8 mm   5/16"
36523	34"	Sewn Prusik 8 mm   5/16"



## Spyder Sewn Prusik 10 mm | 3/8"

Fast action eye and eye hitch cord. Great for DRS|SRS systems.

### SPECS + FEATURES

- Constructed with a Technora outer sheath which is chemical, flame and wear resistant

SKU	IN	PRODUCT
36540	28"	Sewn Prusik 10mm   3/8"
36541	30"	Sewn Prusik 10mm   3/8"
36542	32"	Sewn Prusik 10mm   3/8"
36543	34"	Sewn Prusik 10mm   3/8"



# prusiks + split tails

CLIMBING / PRUSIKS + SPLIT TAILS

## Spyder Technora Split Tail

High melting point split tail, excellent for open double rope systems. Stop prematurely wearing the tail of your climbing line, use a split tail.

### SPECS + FEATURES

- Constructed with a Technora outer sheath which is chemical, flame and wear resistant
- Light weight
- Great for DRS open systems using 24 strand climbing lines
- Diameter: 8 mm | 3/8"

SKU	ATTRIBUTE	PRODUCT
36650	5'	Technora Split Tail



Spyder  
MANUFACTURING / USA

## Eye Splice 16-Strand Split Tail 1/2" 3" Eye

### SPECS + FEATURES

- Hand spliced
- 3" eye for girth hitches or to capture with a keeper
- 1/2" climbing line
- MBS: 5,400 lbs (often exceeds)
- Rope manufacturers and colors vary

SKU	ATTRIBUTE	PRODUCT
SPLITTAIL 1/2 3 EYE	5'	16-Strand Split Tail 1/2" 3" Eye



CUSTOMIZED  
PRODUCT

## Eye Splice 16-Strand Split Tail 1/2" 1" Eye

### SPECS + FEATURES

- Split tail for an open system
- Replaceable Blake or Tautline Hitch
- Eye size: Tight eye
- Diameter: 1/2"
- Construction: 16-Strand
- Cordage: variable 1/2" 16 strand (Samson, Teufelberger, Yale, Sterling)
- Minimally: MBS: 5,000 lbs

SKU	ATTRIBUTE	PRODUCT
SPLITTAIL 1/2 T-EYE		16-Strand Split Tail 1/2" 1" Eye



CUSTOMIZED  
PRODUCT

## Eye Splice 24-Strand Split Tail 11 mm 1" Eye

### SPECS + FEATURES

- Cordage varies: Samson Velocity, Teufelberger Tachyon, Yale Blaze, Yale BlueMoon, and more
- Hand spliced with a tight eye
- Diameter: 11 mm variations
- Variations: Rope manufacturer and color
- MBS: 5,400 lbs (meets or exceeds)

SKU	ATTRIBUTE	PRODUCT
SPLITTAIL 11MM T-EYE		24-Strand Split Tail 11 mm 1" Eye



CUSTOMIZED  
PRODUCT





@Height Yale Beeline Split Tail Prusik 10mm - Eye splice

**SPECS + FEATURES**

- Great for double rope systems using and open style.
- Reduces wear to your climbing line
- High melting point
- Eye splice choice: Sewn or hand spliced
- Supplied by @Height

SKU	ATTRIBUTE	PRODUCT
008895	sewn 5'	Yale Beeline Split Tail 10 mm
007594	spliced 5'	Yale Beeline Split Tail 10 mm





**HEIGHT**

**CUSTOM  
QUALITY  
PRODUCTS**



# mechanicals

## Rock Exotica Akimbo



The Akimbo is a long-awaited SRT (SRS) climbing device that is mid-line attachable. Opens easily to install/remove rope mid-line, without detaching from harness.

### SPECS + FEATURES

- Accepts wide range of rope sizes (See list of approved ropes below).
- Friction adjusts easily without tools.
- Suitable for both SRS and MRS climbing methods.
- SRS chest attachment wire gate provides quick connect/disconnect for cord or small carabiner.
- Ascend, descend and position in the canopy without changing equipment.
- Lightweight and compact
- The initial run will not be CE certified for sale into European CE markets
- Rope Sizes: 11.5 mm – 13 mm (see approved ropes below)



SKU	ATTRIBUTE	PRODUCT
AKIMBO		Akimbo

APPROVED ROPES	WLL: Do not to exceed - 100 kg (220 lb)	WLL: Do not to exceed - 130 kg (286 lb)
The following ropes are approved for use with the Akimbo at the Working Load Limit (WLL) shown below. Only approved ropes should be used with the Akimbo. Working Load is equal to the total weight of the climber including gear. Total Working Load of the climber must not exceed the Working Load Limit (WLL) for the rope listed or slippage may occur!	Samson Voyager Cool, 11.8 mm Teufelberger XStatic 11.7 mm Yale Poison Ivy / Blue Moon 11.7 mm	Cousin Atrax 11.6 mm Sterling Scion 12.5 mm Sterling WorkPro 12.5 mm Sterling HTP 12.5 mm Teufelberger Drenaline 11.8 mm Teufelberger Fly 11.1 mm Yale Scandere 11.7 mm

## Rock Exotica Unicender



Since its inception in 2005, the **Unicender** has been the most flexible tool for tree climbing. With the ability to be used in both Doubled Rope Technique (DdRT) and Single Rope Technique (SRT), the **Unicender** fits the way you like to climb like no other tool.

The **Unicender** utilizes unique friction plates that allow it to advance easily with minimal friction, and virtually no "Sit Back," giving you the most efficiency per stride. Descending is just as easy: by looping the rope around the plates in SRT. Additionally, the **Unicender** attaches conveniently mid-line.

### SPECS + FEATURES

- For rope sizes 11 to 13 mm (7/16" to 1/2")
- Invented by Morgan Thompson and manufactured by Rock Exotica

SKU	ATTRIBUTE	PRODUCT
RG50		Unicender







# akimbo

For Stationary Rope / Moving Rope Systems — Made in USA

The AKIMBO is a versatile, mid-line attachable friction device that allows climbers to ascend and descend stationary or moving rope systems without needing tools or changing equipment.

Learn more at:  
[www.rockexotica.com](http://www.rockexotica.com)

\*Only use ropes approved by Rock Exotica. Consult user manual or website for details.

Patented





# mechanicals + friction fitches

CLIMBING / MECHANICALS + FRICTION FITCHES

## @Height Rope Wrench Double Tether



@Height's Wrench Tether collaborated with Eric Whipple to make this sewn tether for the Rope Wrench.

SKU	ATTRIBUTE	PRODUCT
8541104	9.5"	Rope Wrench Double Tether
8541ST4	12"	Rope Wrench Double Tether

### SPECS + FEATURES

- Lightweight and stiff
- Constructed out of Sterling Ropes 6 mm Power Cord
- Sewn, 2 legs - can be used separate or together.



A brand that I use quite frequently is @height. @height supplies my rope wrench tethers for my single line access and they also sew most of the eye to eyes that I use for my prusik cords. They do a great job with making their products when it comes to construction, style and usefulness. With any @height product I have ever used, I have always had a good experience with everyday tree production to just including it into mountaineering setups or rec climbing. They always hold up and have never failed me. I would highly recommend @height products to anyone who is in the tree care industry or any type of work that includes rope ascent or decent!"

—Corey Gagne, Professional Arborist, MA

## Rope Logic FIX Tethers



Rope Logic's FIX Tether is the great choice for your Rope Wrench. Both the single and double eye versions offer a small loop sewn into the tether for easy tending, and the FIX single eye works perfectly with the Pinto-style pulley and the double eye works with the Hitch Climber-style pulley.

### SPECS + FEATURES

- Super rigid - Constructed of Neon Green 5/16" (8 mm) Yale Beeline
- Short loop built in for an easy connect point to your chest harness for SRS ascents
- Tensile Strength: 5,500 lbs (24.4 kN)
- WLL: 550lbs (2.4 kN)

SKU	ATTRIBUTE	PRODUCT
40066	9"	Short Single Tether
011313	10.5"	Single Tether
011312	10.5"	Double Tether



## ISC Rope Wrench - 11 mm



The ISC Rope Wrench is used to create a 'bend' in the rope, above the climber's hitch. With the addition of a stiff tether, the STRW created a 'contained double rope system', on a single line of rope. This contained double rope system travels with the climber as they move around the tree, allowing a consistent level of friction on the hitch, which is impossible to achieve in double rope climbing.

### SPECS + FEATURES

- Weight: 128 g | 5 oz
- Compatible with Rope Diameter Range: 11 mm (7/16")
- Wheel and Body Material: Aluminum; Body Finish: Anodized

SKU	ATTRIBUTE	PRODUCT
RP280B1	Black	Rope Wrench 11 mm
RP280F1	Gold	Rope Wrench 11 mm
RP280C1	Purple	Rope Wrench 11 mm
RP280D1	Orange	Rope Wrench 11 mm
RP280A1	Red	Rope Wrench 11 mm





## ISC Rope Wrench - 13 mm

**NEW!** RP283 (assembled part) - Optimized for SRS/SRT climbing on 13 mm (1/2") lines. Ever use a wrench on your 1/2" line and feel it just struggle a bit? The RP283 combo is smooth as silk. This wrench was designed for 13 mm lines and you'll appreciate and love it, especially maneuvering on SRS limb walks.

Includes:

- (1) x ISC Rope Wrench RP283
- (1) x @Height's 12" double tether

### SPECS + FEATURES

- Compatible with Rope Diameter: 13 mm (1/2")
- Weight: 130g | 6 oz
- Material: Aluminum; Body Finish: Anodized

SKU	ATTRIBUTE	PRODUCT
RP283	Red	Rope Wrench 13 mm

NEW  
OPTIMIZED  
FOR SRS/SRT  
CLIMBING



Not all items pictured are included.

## Taz LOV2

The **LOV2**, is the first device that allows you to replace 3 devices: Fall arrest device, Descender, and Chest ascender switching into descender. The only device of it's kind that can function on tensioned ropes, tram lines, and diagonal ropes.

### SPECS + FEATURES

- Ease of use
- For single line ascents and descents
- Rope diameter: 10 - 11 mm
- EN 358 | EN 12841 A/C
- Weight max. 120 kg | 264 lbs

SKU	ATTRIBUTE	PRODUCT
PM30-BL	Black	Taz LOV2
PM30-R	Red	Taz LOV2



## RopeTek™ Hitch Hiker™ 2

The **Hitch Hiker (HH) 2** system is a steel hybrid device which tends and assists your friction hitch in both SRS and MRS climbing. Popular with climbers doing crane work or want the steel feel.

NOTE Due to feedback from many the original HH users, RopeTek chose to not include the hitch cord to allow climbers to choose the cordage they feel most comfortable using.

### SPECS + FEATURES

- Meet the 2 - now lighter and more compact
- Industrial, galvanized side plates made of Nickel coated AR400S
- Spine is 7075 aluminum
- Includes:
  - 1 - Hitch Hiker 2
  - 1 - Dog bone made of pre-hardened 4140 steel
  - 1 - CT Steel Pillar TG Carabiner (MPN: 3c4460a)

SKU	ATTRIBUTE	PRODUCT
HITCH HIKER		Hitch Hiker 2
BONE		Hitch Hiker 2 Replacement Bone



Hitch cord and carabiner included; rope not included.

# mechanicals + friction fitches

CLIMBING / MECHANICALS + FRICTION FITCHES

## Kong Futura Ascender

The **Futura** is here. A radical new approach to climbing ropes. Surprisingly simple the new designs are comfortable to use thanks to the ergonomic grips. Allows users hand to sit comfortably inside the device close to the rope the same way you would grabbing the actual rope.

### SPECS + FEATURES

- Comes with 2 different sized handles for ergonomic comfort
- Available in right and left versions
- Great for open ascent events
- Very lightweight
- Rope capacity: 8 mm - 12.7 mm
- Weight: 125 g
- CE EN 567CE EN 12841/BNFPA-L 1983:06

SKU	ATTRIBUTE	PRODUCT
87600NY4DK		Futura Ascender

SMALL, LIGHT,  
FITS IN PALM  
OF YOUR HAND!



## Kong Lift Hand Ascender

All the components are part of the latest generation of **Kong** blockers. Excellent ability to block out particularly on muddy and icy ropes thanks to the holes on the cam and on the side plate. The new material and a special chemical and thermal process give to the cam, in addition to black color, a much higher surface hardness. The result is a great wear resistance and a reduction of the fragility that usually penalizes steels by quenching to low temperatures.

### SPECS + FEATURES

- New opening lever, ergonomic, easy to handle and protected from shocks and from the risk of accidental opening.
- Fitted with anti-overturning system of the cam.
- Materials: Aluminum Alloy
- Weight: 225 g
- Rope Diameter: 8-13 mm
- Certs: CE EN 567, CE EN 12841/B

SKU	ATTRIBUTE	PRODUCT
KNG896D	Right	Lift Hand Ascender
KNG896S	Left	Lift Hand Ascender



## Climbing Technology Quick Roll

Innovative ascender handle with integrated pulley. Much more effective and less clumsy than the traditional ascending handles with their additional connector: the working rope runs from the descender over the integrated pulley, thus reducing friction and facilitating the ascent.

### SPECS + FEATURES

- Cam opening lever usable with one hand, with a single downwards movement
- Wear-resistant steel blocking cam, with depressions to avoid the accumulation of dirt and mud and reduce force needed to slide device up the rope in difficult conditions (muddy, iced-up ropes);
- 2 additional attachment points, system to prevent cam inverting and secondary hole for connecting an etrier with a quick link.
- Great for Open Ascent Event for a quick connect to weight your line.
- Rope diameter: 10-13 mm
- Weight: 0.2 lbs

SKU	ATTRIBUTE	PRODUCT
2D663SJ	Left	Quick Roll
2D663DJ	Right	Quick Roll



GREAT FOR SRS LIMB WALKS



## CMI Ultrascender Hand Ascender

The **CMI Ultrascender Large** features an ergonomic safety mechanism and thumb notch on the cam make this an easy ascender to operate. CMI guarantees their cams, springs and safeties for life.

### SPECS + FEATURES

- Ascender body is extruded from aircraft grade aluminum and stainless steel, and finished with a hard powder coat to permanently protect them from the elements.
- Cams are cast from chromemoly steel and finished with a non-metallic finish that gives them the same corrosion resistance as stainless steel
- Springs are tested to over a million cycles, simulating lifetimes of the most demanding use.
- Rope Capacity: up to 5/8"
- Length: 7.4" x 3"
- MBS: 4,600 lbs
- Weight: 9.5 oz

SKU	ATTRIBUTE	PRODUCT
ULT01R	Red	Ultrascender



Rope not included.

**CMI**

## Kong Cam-Clean Chest Ascender

The **Kong Cam-Clean Chest Ascender** rope clamp was specifically conceived for climbing, caving, rescue, work on height, and canyoning. Excellent ability to block out particularly on muddy and icy ropes thanks to the holes on the cam.

### SPECS + FEATURES

- Aluminum Alloy
- Fits ropes 8 mm - 13" diameter
- Excellent ability to block out particularly on muddy and icy ropes
- Fitted with anti-overturning system of the cam
- Length: 4.52" (115 mm), Width: 3.07" (78 mm), Height: 1.49" in. (38 mm)
- Weight: 5.29 oz (150 g)
- EN 567 Certified and CE EN 12841 type B Certified

SKU	ATTRIBUTE	PRODUCT
82400R400KK	Red	Cam-Clean Ascender



**KONG**

## CAMP Turbo Chest Ascender

Proprietary rollers increase climbing efficiency and decrease wear and tear on the device and ropes.

### SPECS + FEATURES

- Super smooth action and increased safety on traversing maneuvers
- Thicker body plates and a shaped connection point reduce shifting between the device and the connector
- Can be setup as a locking pulley for light hauling
- Rope Diameter: 8-13 mm
- Weight: 4 oz
- Weight Capacity: 50 - 110 lbs
- Certification(S): EN 567, UIAA, CE, EN 12841/B, EN 12841 Type B

SKU	ATTRIBUTE	PRODUCT
2256		Turbo Chest Ascender



**CAMP**

# ascenders

CLIMBING / KNEE ASCENDERS

## Weaver HAAS Velox

The **HAAS Velox** makes the original **HAAS** even better; the *floating knee ascender*. The HAAS is a unique ascent tool designed by Michael Frankhauser from the U.S. It gives the climber an easier and faster way to ascend. It can be added to double rope systems, SRT systems, with the Rope Wrench, Hitchhiker, or without. The **HAAS** Features a fully integrated knee ascender that captures all of the advancement made by your other foot. It does this by allowing the bungee to run past the ascender all the way to the foot through a liner where it then pulls the lower tether and ascender up the line from the bottom when it is un-weighted. The result is a smooth efficient ergonomically correct ascent that uses major muscle groups evenly and drastically reduces fatigue and stress. If you ever thought it would be cool to use two foot ascenders here is your chance.

### SPECS + FEATURES

- Fully integrated system, bungee, tether, and ascender, all in one piece, which operates below your hitch and only on one side.
- Additional 18" of bungee in the system
- One size fits all, zero set up, efficient rope access tool.
- Snap is tied just above the ascender and will extract out 30 inches
- Sizing setup time eliminated
- Removes 'dead spots' in return action
- 3 types: Regular fits 5'8" climbers and taller; Short: for those <5'8"; Clip N Step: clip directly to ArbPro boot loops; Works well with ArbPro Clip N Step boots, or with an added separate footloop.

SKU	ATTRIBUTE	PRODUCT
0898111	Short	HAAS Velox
0898110	Regular	HAAS Velox
0898109	Clip N Step	HAAS Velox





## 4SRT Floop Foot Loop for Climbing Boots



### SPECS + FEATURES

- 4SRT provides a specialty range of equipment designed by arborists for SRT (Single Rope Technique) climbing.
- For climbing boots

SKU	ATTRIBUTE	PRODUCT
T4FL1		Floop Foot Loop



## Edelrid PROSTEP II



The **PROSTEP** is designed for ascending ropes in combination with the ELEVATOR ascender. The foot loop made of 20 mm webbing is easy to use and allows an effective and low-fatigue ascent. The **PROSTEP** is individually adjustable thanks to the Slide Block BUCKle.

SKU	ATTRIBUTE	PRODUCT
890131200170		PROSTEP II



## CAMP Turbo Foot Ascender



CAMP's small foot ascender is the latest in the group of quick-release foot ascenders.

### SPECS + FEATURES

- Proprietary rollers are placed on the ascender body where the rope travels providing a smooth, fast movement of the rope
- Rollers provide less wear to rope and ascender
- Toothed cam is finished with a special anti-wear treatment
- Innovative strap design provides a secure fit to any kind of footwear; strap aligns with direction of the force being applied for optimal comfort and efficiency.
- Rollers also allow the Turbo Foot to be rigged as a locking pulley for light hauling with a max load of 50 kg, 110 lbs.
- Rope Diameter: 8mm - 13 mm
- Lightweight: 135 g (4.8 oz)

Safety Notice: Used as a locking pulley configuration is not intended for hauling or securing of bodies. The Turbo Foot is for progression only and must not be used as a safety attachment

SKU	ATTRIBUTE	PRODUCT
2258 RED	Right	Foot Turbo
2259 GRAY	Left	Foot Turbo



QUICK ROPE RELEASE (ADD LONG STRAP OR A CARABINER THROUGH HOLE TO KEEP FROM KICKING OUT.)

## Climbing Technology Foot Ascender



The **CT Quick Step Foot Ascender** from Climbing Technology of Italy is lightweight, compact and efficient. Has a deeper channel and an improved cam release to prevent your climbing rope from accidentally kicking out. Thoughtful design gives the CT version an edge over other models.

### SPECS + FEATURES

- Dimensions: 3.2" x 2.6" (83 x 65 mm)
- Rope Capacity: 5.16"-1.2" (8 mm - 13 mm)
- Weight: 6.95 oz (197 g)

SKU	ATTRIBUTE	PRODUCT
2D654D RIGHT	Right	Quick Step Foot Ascender
2D654S LEFT	Left	Quick Step Foot Ascender



MANUAL ROPE RELEASE

# ascenders

CLIMBING / FOOT ASCENDERS

## Edelrid Foot Cruiser



Sophisticated foot ascender that enables efficient and low-fatigue climbing on the rope. A pre-installed but removable rope safety device prevents unintentional release. The locking mechanism of the **FOOT CRUISER** is easy to operate – even with your feet. The ascent loop is fitted with an abrasion protector.

SKU	ATTRIBUTE	PRODUCT
882500000170	Right	Foot Cruiser
882490000060	Left	Foot Cruiser



## CMI Foot Ascender



This rugged, practically bomb proof foot ascender is fondly referred to as the little brick or the juice box. Tried and true, one of the original foot ascenders in the industry.

### SPECS + FEATURES

- Secure webbing straps, snugly fit to your foot
- Quick and easy to adjust
- Easy to find
- Color: Blue
- Weight: 0.7 lb

SKU	ATTRIBUTE	PRODUCT
FIASCR	Right	Foot Ascender
FIASCL	Left	Foot Ascender



GREAT FOR  
LARGE LUGGED  
SOLED BOOTS

## ISC Stryder Foot Ascender



ISC's **Stryder Foot Ascender** is created with the arborist specifically in mind. It includes a lightweight cam with a coned face for firm and reliable grip with minimal wear on your rope.

### SPECS + FEATURES

- Foot-operable cam lever; can be removed
- Webbing straps tighten quickly and securely; creep-free webbing
- Tuned cam-spring for smooth and secure operation
- Rope Range: 8-13 mm (5/16 - 1/2")
- Dimensions: 75 x 52 x 25 mm (3 x 2 x 1")
- Weight: 198 g (7 oz)
- Material: Aluminum (Anodized), stainless steel cam
- MBS: 2.5 kN (562 lbf)
- WLL: 140 kg (308 lb)

SKU	ATTRIBUTE	PRODUCT
RP227A1	Right	Stryder Foot Ascender
RP228A1	Left	Stryder Foot Ascender

GREAT PULL TAB TO  
REMOVE FROM FOOT;  
HAS REMOVABLE ROPE  
LOCKING MECHANISM



THE LOCK MECHANISM CAN BE  
DISENGAGED WITH YOUR FOOT.



# basal anchors

## ART Snake Anchor

The **Snake Anchor** from **ART** serves as lanyard and anchoring device, it can be continuously adjusted thanks to the stitched intervals. The **Snake Anchor** can be installed open and used as friction device with pulley or biner in the desired length. It also can be installed in choking mode and continuously adjusted as well. Because of the tube shaped ring this procedure works much better than with any other tool known so far.

The one-and-only combination system of tube shaped ring, parallel sewn 8 mm polyamide rope as well as segment stitching makes for a strong, versatile and easy to use tool in everyday work situations. If you want to secure or block the choked sling, you just need to install a small binder into an open rope segment right in front of the ring. Climbing ropes can be fastened as lower anchor. This way you can for example install a lowering device for aerial rescue at any given place.

### SPECS + FEATURES

- Used as basal or upper anchor
- Segment stitching makes for continuous adjustments
- Securing position in choking mode installation with non-locking carabiners
- To be used as adjustable friction saver with biners or pulleys
- Great abrasion resistance and wide contact surface based on parallel sewn 8 mm double strand polyamide rope
- High load capacity plus protection of eye with tube shaped ART ring
- Better security and tensile strength based on even load distribution onto whole of tube shape ring structure

SKU	ATTRIBUTE	PRODUCT
SA-16	16'	Snake Anchor
SA-8	8'	Snake Anchor



## Sterling BARC

**Sterling's BARC** or Big Ass Rigging Chain is what the Sterling field testers dubbed it. Actually, **BARC** stands for Basal Anchor Rigging Chain, but who are we to argue? Try one and you'll be a believer.

Building on the popularity of Sterling's versatile Chain Reactors, the **BARC** is made from 1" T9800 nylon webbing sewn into individual full-strength loops for an adjustable and incredibly strong chain.

### SPECS + FEATURES

- Designed for use as a basal anchor with your Portawrap or other friction brake lowering device
- BARC can also accommodate your rigging block aloft. BARC comes in 5ft and 8.5ft versions to accommodate trees up to 19" and 32" in diameter, respectively.
- MBS: 6,182 lb, each individual loop has a strength rating of over 11,000 lb
- Available Length: 5' (8.5' is the Red)
- Standards: ANSI Z133

SKU	ATTRIBUTE	PRODUCT
SW25498RC10	8.5'	BARC - Red
SW25498RC60	5'	BARC - Blue

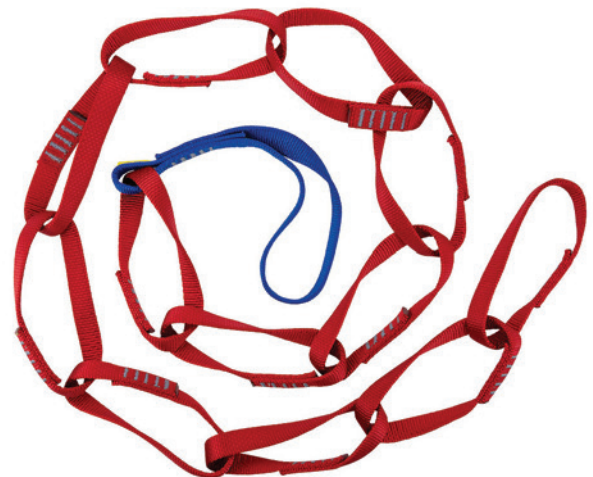

STERLING

# descenders

## DMM Anka

At 169g, the **Anka**, is the heaviest of all our abseil devices; this extra mass means it has excellent heat dissipation qualities. The added bonus of course is that it is incredibly durable.

### SPECS + FEATURES

- Heavy duty abseil device
- 90 degree twist 'anchor' design optimizes loading on harness belay loop
- Larger mass offers greater heat dissipation and increased durability
- Anodized for corrosion resistance
- Wings prevent accidental lock-up
- MBS: 6,750lbs
- Weight: 169g

SKU	ATTRIBUTE	PRODUCT
A1100		Anka



## DMM Cardiac Arrestor

The **Cardiac Arrestor** has a subtle kinked shape which allows for this. If you're using fatter ropes, flip it one way for a smoother ride. Conversely, if you're using skinny ropes, flip it the other way for greater control.

### SPECS + FEATURES

- Kinked shape allows high or low friction options
- Anodized for corrosion resistance
- Weight: 133g

SKU	ATTRIBUTE	PRODUCT
A1110		Cardiac Arrestor



## DMM Abseil Figure 8

DMM's **Abseil Figure 8** balances weight, strength, usable friction and heat control so well and is a true classic in every sense of the word. Medium in size it's a true simple, classic, and no frills design with a very affordable price tag. Lightweight, very hard wearing and exceptionally strong.

### SPECS + FEATURES

- Hot forged and fully heat treated aluminum for lightness and strength
- Anodized to BS12373-2001 Class 10E1
- Sealed for corrosion protection
- MBS: 25kN
- Rope Size: 11 -16 mm
- Weight: 116g
- Color: Varied

SKU	ATTRIBUTE	PRODUCT
A1150		Abseil





### Kong Rescue Figure 8



**Kong's Figure 8** Descender with ears (or wings) to create a locking knot. The ears are designed to prevent the rope from slipping up to the top and forming a girth hitch which can strand the climber who is rappelling until they can remove their weight from the device. The large central opening allows you to overcome any knots.

**SPECS + FEATURES**

- Finish: Anodized, Hot forged
- MBS: 40Kn
- Rope Size: 9 - 16 mm
- Weight: 0.6 oz
- Color may vary between Silver, Red, or Blue

SKU	ATTRIBUTE	PRODUCT
80506R400KK	Aluminum	Rescue Figure 8



### Kong Classic Figure 8 Descender



**Kong's figure 8** provides one of the smoothest, easiest to control descents of any device. The **Kong Classic Figure 8** will also outlast most other rappel devices.

**SPECS + FEATURES**

- Smooth, easy to control
- Long lasting and affordable
- Weight: 135 grams
- Strength: 35kN
- Rope Diameter Range: 9mm - 12mm

SKU	ATTRIBUTE	PRODUCT
80503K400KK	Aluminum	Classic Figure 8 Descender



**KONG USA**

Quality climbing gear... since 1830

[www.kongusa.com](http://www.kongusa.com)

# descenders

CLIMBING / DESCENDERS

## Kong Oka Figure 8 Descender

Ease of operation, diversity of progression techniques on ropes of different diameters, and the multitude of braking positions are characteristics achieved through its joint development with rescue technicians.

### SPECS + FEATURES

- Quick, safe and effective function in all conditions
- Supplied with two spare rubber parts.
- Weight: 95g
- Certs: CE EN 15151-2

SKU	ATTRIBUTE	PRODUCT
80508N400KK	Aluminum	Oka Figure 8 Descender



## US Rigging ProClimb Big 8 Stainless Steel Descender

The **Big 8 Stainless Steel Descender** meets CE and UIAA standards and is rated at 11,240 lbs tensile strength. Made from high polished stainless steel, this descender can be used in an array of activities including arboriculture, rescue, recreational climbing and more.

### SPECS + FEATURES

- MBS: 50 kN (11,240 lbs)
- Rope Size: 11 -16 mm
- Weight: 1.63 lbs
- Color: Silver

SKU	ATTRIBUTE	PRODUCT
USR850S		ProClimb Big 8 Stainless Steel Descender



## Spyder Climb Right Classic Figure 8 Descender

### SPECS + FEATURES

- Material: Aircraft Grade Aluminum
- Length MBS: 35 kN
- Length: 5 3/4"

SKU	ATTRIBUTE	PRODUCT
85281		Climb Right Classic Figure 8 Descender





# climbers + spikes

## Edelrid TALON Tree Climbers

The **TALON** is one of the lightest climbing gaffs on market. Built on a completely new design that maximizes the highest level of flexibility and comfort

### SPECS + FEATURES

- Impressively light at 2.43 lbs (each)
- Ergonomically designed for your leg
- Gaff length: 70 mm | 2 3/4"
- Type-C Climber
- Steel Shaft
- Calf size: 33 cm (12.99") to 48 cm (18.9")
- Length adjustability: 38 cm (14 3/4") to 47 cm (18 1/2")

SKU	ATTRIBUTE	PRODUCT
882950700170	Tree 2 3/4"	Talon Tree Climbers



EDELRID 

CAN BE OUTFITTED WITH AN ATTACHABLE FOOT ASCENDER

## Edelrid Talon Pole Climbers

The **TALON** is built on a completely new design that maximizes ergonomics and allows the highest level of flexibility and comfort.

### SPECS + FEATURES

- Lightweight and durable steel construction
- Ventilated mesh on the padding for better breathability
- ASTM F887-16 conformity
- 3 directional adjusting system on the lower binding for a perfect fixing of the boot
- All textile part are easy to remove and wash, as well as to replace when worn out
- Weight: 5.6 lbs | 2500 g

SKU	ATTRIBUTE	PRODUCT
882930430170	Pole 1 5/8"	Talon Pole Climbers



EDELRID 

## Miller Antec AXESS Climbing Spurs

The semi-rigid plastic shell ensures excellent support for the calf and an ergonomic shape that perfectly matches the shape of the leg by adapting to the morphology of the spur for a feeling of flexibility and freedom of movement. The triangular tip is very resistant and fits easily into the tree and flat below to provide excellent support. Last but not least: the **AXESS** climbers are very light and the parts are interchangeable.

### SPECS + FEATURES

- Aluminum shanks
- Ergonomically shaped, bent outward
- Shell in rigid ABS
- Adjustable in height, slightly inclined towards the front.
- Removable steel tip, affable to three sharp faces.
- Textile and velcro straps.
- Weight: 5.8 lbs

SKU	ATTRIBUTE	PRODUCT
1014990	Tree	AntecAxess Aluminum Spurs



MILLER 

# climbers + spikes

CLIMBING / CLIMBERS + SPIKES / CLIMBERS

## BUCK Steel Tree Spurs – Complete Kit

BUCK's Steel Tree Climber (Spurs) have a contoured shank, straight stirrup and a dowel & screw replaceable gaff.

### SPECS + FEATURES

- Nylon leg straps (MPN: 2239)
- Nylon foot straps (MPN: 21391)
- Climber pads (MPN: 3122)
- Includes standard length sleeves (MPN: 9204)
- Adjustable: 16 1/4" to 18 3/4"
- Long sleeves can adjust from 19 1/4" to 21 3/4" by special order. (MPN: 9202L)
- Replaceable Gaff

SKU	ATTRIBUTE	PRODUCT
SB93059	Replaceable L-Pad 2 5/8"	Steel Tree Spurs – Complete Kit



BUCK  
1898

## BUCK Contoured Steel Tree Climbers (Spurs) with Foot Straps

BUCK  
1898

### SPECS + FEATURES

- Permanent Gaff
- Contoured Shank
- Straight Stirrup
- Nylon Foot Straps (MPN: 21391)
- Gaff Angle: 23°
- Material: Steel
- Sleeves: Standard length sleeves adjusting from 16 1/4" to 18 3/4"
- Special order Long sleeves (MPN: 9202L): Adjust from 19 1/4" to 21 3/4"

SKU	ATTRIBUTE	PRODUCT
91429R	No Pad	Buck Steel Tree Spurs w/ Foot Straps



## BUCK Steel Contoured Shank Replacement Gaff Tree Climbers

BUCK  
1898

### SPECS + FEATURES

- Offset tree climbers with 2-3/4" screw type replaceable tree gaffs, sleeve adjustment from 16-1/4" to 18-3/4"
- Rated to 350 lbs per pair
- Black with chrome colored sleeves
- Contoured shank for ankle relief and comfort
- Offset stirrup prevent climber from moving back to heel of foot
- Dowel & screw style replaceable gaffs with, 23° angle
- SB95059 comes with footstraps, leg straps, and climber pads

SKU	ATTRIBUTE	PRODUCT
SB95059	L-Pad 2 3/4"	Steel Contoured Shank Repl. Gaff Tree Climbers





**Spyder Climb Right Aluminum Spurs** are lighter than steel climbers while maintaining high strength. Made by **Spyder Manufacturing** with a straight shank from tempered aluminum. The bottoms of the climbers are textured for better grip when walking on tree limbs. The gaffs are made in **Spyder's** new "Quick Change" style, with a two-screw design that lets you switch or replace gaffs quickly. The top screw is fully threaded through the gaff, giving the operator a visual guarantee the gaff is completely tightened to the climbing stirrup. Choose the right combination for your climbing needs. Climb Right recommends a combined body, clothing and tool weight of 350 lbs.

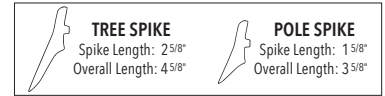

## Spyder Climb Right Aluminum Spurs

### SPECS + FEATURES

- No Straps; No Pads
- Straight shank and offset stirrup
- Gaffs are interchangeable
- Adjustable in height from 15 3/4" to 18 3/4"

SKU	ATTRIBUTE	PRODUCT
91260	Pole 1 5/8"	CTB Aluminum Pole Spurs
91220	Tree 2 5/8"	CTB Aluminum Tree Spurs



## Spyder Climb Right Climbing Kit w/ Lower Straps Only

### SPECS + FEATURES

- Lower Straps; No Pads
- Straight shank and offset stirrup
- Gaffs are interchangeable
- Adjustable in height from 15 3/4" to 18 3/4"

SKU	ATTRIBUTE	PRODUCT
91262	Pole 1 5/8" (no pads)	CTB Pole Climbing Kit w/ Lower Straps
91222	Tree 2 5/8" (no pads)	CTB Tree Climbing Kit w/ Lower Straps



## Spyder Climb Right Climbing Kit w/ Straps & L Pads

### SPECS + FEATURES

- Kit with Spurs, Straps, and L Pads
- Straight shank and offset stirrup
- Gaffs are interchangeable
- Adjustable in height from 15 3/4" to 18 3/4"

SKU	ATTRIBUTE	PRODUCT
91264	Pole 1 5/8"	CTB PoleClimbing Kit w/ Straps & L Pads
91224	Tree 2 5/8"	CTB Tree Climbing Kit w/ Straps & L Pads



# climbers + spikes

CLIMBING / CLIMBERS + SPIKES / CLIMBERS

## Spyder Climb Right Climbing Kit w/ Straps & T Pads

### SPECS + FEATURES

- Kit with Spurs, Straps, and T Pads
- Straight shank and offset stirrup
- Gaffs are interchangeable
- Adjustable in height from 15 3/4" to 18 3/4"

SKU	ATTRIBUTE	PRODUCT
91266	Pole 1 5/8"	CTB Pole Climbing Kit w/ Straps & T Pads
91226	Tree 2 5/8"	CTB Tree Climbing Kit w/ Straps & T Pads



Spyder  
MANUFACTURING / USA

## Spyder Climb Right Climbing Ultra Kit w/ Straps

### SPECS + FEATURES

- Kit with Spurs, new Ultra Lite aluminum climbing pads and composite lower straps (no upper straps needed, pads attach using velcro)
- Ultra Lite pads are very comfortable and extremely lightweight, 20.4 oz per set
- Straight shank and offset stirrup
- Gaffs are interchangeable
- Adjustable in height from 15 3/4" to 18 3/4"
- Manufactured to ASTM-F-887-97 standards

SKU	ATTRIBUTE	PRODUCT
91265	Pole 1 5/8"	CTB Pole Climbing Ultra Kit w/ Straps
91225	Tree 2 5/8"	CTB Tree Climbing Ultra Kit w/ Straps



Spyder  
MANUFACTURING / USA



Image courtesy of  
Buckingham Manufacturing





## Edelrid Talon Upper and Lower Straps

Available separately. Washable Velcro straps for the foot.

SKU	ATTRIBUTE	PRODUCT
882980000170		Talon Calf Upper Straps (2 Pair)
883000000170		Talon Lower Straps (Pair)



882980000170



883000000170

## BUCK Hook and Loop Fastener Lower Straps



The patented **Hook and Loop climber straps** are **BUCK's** newest addition to foot straps.

### SPECS + FEATURES

- Offers an increased surface area for added comfort to the top and back of the foot.
- The hook and loop cinch provides a fast and easy attachment and an extra tight fit.
- Length Strapped: 17"; Length UnStrapped: 29"
- Width Hook and Loop Nylon Fastener Strap: 1.75"; Width Chaff: 3.25"
- Weight: 4.6 oz

SKU	ATTRIBUTE	PRODUCT
21401C	29"	Hook and Loop Fastener Lower Straps (Pair)



COMFORTABLE AND ALLOWS FOR TIGHT, FINE TUNE ADJUSTING!

## Miller Antec AXESS Strap Kit



Comes with strap and two screws.

SKU	ATTRIBUTE	PRODUCT
1014997		Antec AXESS Upper Strap Kit
1014999		Antec AXESS Strap Ankle Strap Kit



1014997



1014999

# climbers + spikes

CLIMBING / CLIMBERS + SPIKES / CLIMBING STRAPS

## Weaver Latigo Leather Climber Straps

Weaver Latigo Leather Straps are pliable and comfortable.

### FEATURES

- Constructed of 1" wide pliable yellow top grain Latigo steer hide leather that's riveted for extra strength.
- Roller buckles and leather wear pads reduce abrasions.
- Ten oblong holes for size adjustment.
- Overall lengths of straps are 26"



089700126

### SPECS

- Nickel plated hardware.
- Sold in pairs.



SKU	ATTRIBUTE	PRODUCT
089700126	Leather	26" Upper Leg Climber Straps (Pair)
0897050	Leather	26" Split Ring Lower Climber Straps (Pair)



0897050

## Weaver Neoprene Climber Straps

Heavy-duty coated webbing offers the perfect combination of durability and comfort.

### FEATURES

- Riveted 1" heavy-duty coated webbing straps are extremely durable.
- Straps are pre-cut, pre-punched and heat-sealed by the manufacturer to prevent fraying and ensure a quality end product
- Roller buckles and top grain yellow Latigo steer hide leather wear pads resist abrasion
- Fourteen holes for perfect adjustment



0898001 08-98001-28

### SPECS

- Nickel plated hardware.
- Sold in pairs.



SKU	ATTRIBUTE	PRODUCT
0898001	Neoprene	26" Upper Leg Climber Straps (Pair)
08-98001-28	Neoprene	28" Upper Leg Climber Straps (Pair)
0898050	Neoprene	26" Split Ring Lower Climber Straps (Pair)



0898050





# ***The Ultimate Climbing Experience***

Elevate your workday with gear designed for the perfect combination of **QUALITY**, **SAFETY** and **COMFORT**. Since 1973 when our founder began producing saddles in central Ohio until today, Weaver Arborist has a rich manufacturing heritage with an emphasis on quality materials, skilled craftsmanship and thoughtful design for hardworking performance you can trust.

[www.weaverarborist.com](http://www.weaverarborist.com)

20-3434-AR



# climbers + spikes

CLIMBING / CLIMBERS + SPIKES / CLIMBING PADS

## Edelrid Talon Calf Padding (L+R) Night



### SPECS + FEATURES

- Calf padding with ventilated mesh for enhanced breathability.
- Only available in a set.
- Washable padding.

SKU	ATTRIBUTE	PRODUCT
883010000170		Talon Calf Padding (L+R) Night



## Miller Antec AXESS Replacement Foam Padding



### SPECS + FEATURES

- Contains two foam replacement pads.
- Weight: 0.2 lbs

SKU	ATTRIBUTE	PRODUCT
1015003		AXESS Repl Foam Padding



## BUCK Cushion Wrap Pad (4")



BUCK Cushion Wrap Pad (4") compatible with: TB / SB / Perm

### SPECS + FEATURES

- A hook and loop pad that features an angled shank
- Comes with a steel insert and with a cinch loop
- Material: Leather / Felt
- Width: 4" x Height: 7.5"
- Weight: 1.5 lb
- User Weight Capacity: 350 lbs

SKU	ATTRIBUTE	PRODUCT
3502C	Leather	Velcro 4" Wrap Pad with Insert



## Miller Antec AXESS Plastic Leg Wrap



### SPECS + FEATURES

- Blue ABS plastic protective wrap

SKU	ATTRIBUTE	PRODUCT
1015007		AXESS Pad Protecting Plastic



## BUCK Steel Insert Angled



Angled replacement steel inserts for 3502C.

### SPECS + FEATURES

- Width: 7"; Length: 2"
- Weight: 9.6 oz

SKU	ATTRIBUTE	PRODUCT
3502CKL		Steel Insert For 3502C



## BUCK C Pad with Insert



### SPECS + FEATURES

- New, stronger metal insert that will hold up to the vigorous use in the field.
- "C" pad has a new thicker, oversized felt liner for additional comfort
- Liner edge minimizes chafing on the leg and the metal insert prevents the climber shank from shifting on the calf, reducing irritation.
- Requires 26" strap sold separately

SKU	ATTRIBUTE	PRODUCT
35032	Leather/Felt	C Pad W/ Insert





## Weaver Latigo Leather Climber Pad L-Shaped

### SPECS + FEATURES

- Provide foam-cushioned comfort for the back of leg and calf
- Soft 1" thick foam liner layered between an outer layer of yellow top grain Latigo steer hide leather and an inner layer of soft brown oil tanned top grain steer hide leather to provide extra comfort and protection to the back of leg and calf.
- Securely lock stitched for durability.
- Sold in pairs.

SKU	ATTRIBUTE	PRODUCT
0897158	Leather	Climber Pad L-Shaped



## Weaver Latigo Leather Climber Pad T Felt

Weaver's T-shaped climber pads are held more securely in place by two means. Pliable burgundy top grain Latigo steer hide leather is lock stitched and riveted to brown oil tanned top grain steer hide leather to form a tunnel for a climber shank.

### SPECS + FEATURES

- One inch slots allow climber straps to be threaded through
- 1/2" felt lined for better comfort
- Felt is lock stitched and riveted to the soft brown oil tanned top grain leather
- Nickel plated rivets
- Sold in pairs

SKU	ATTRIBUTE	PRODUCT
0897156	Leather/Felt	Climber Pad T Felt



## Weaver Super Climber Pad

### SPECS + FEATURES

- Constructed of durable, weather-resistant top grain steer hide harness leather lined with 1/2" black felt.
- Felt liner and smoothed leather edges help prevent rubbing and chafing.
- Lock stitched for long-lasting, dependable use.
- Extra large 9" x 12", these pads evenly distribute pressure over calf for comfort.
- A tunnel for the climber shank and 1-1/4" slots for climber straps help hold pad in place.
- Requires two 26" climber straps to secure pad and climber shank to leg.
- Nickel plated rivets.
- Sold in pairs.

SKU	ATTRIBUTE	PRODUCT
0897157	Leather/Felt	12" Super Climber Pad



## Weaver ProCool™ Velcro Climber Pads

### SPECS + FEATURES

- Weaver ProCool Mesh Technology allows air circulation for a cooling effect.
- Velcro Strap provides adjustability around the calf.
- Fit securely on calf when combined with the appropriate metal bracket.
- Sold per pair.
- Metal formed plates are not included.
- Insert Not Included

SKU	ATTRIBUTE	PRODUCT
0897177	Leather/Mesh	12" ProCool Velcro Climber Pads



# climbers + spikes

CLIMBING / CLIMBERS + SPIKES / CLIMBING PADS

## Weaver Velcro Wrap Pads Angled

### SPECS + FEATURES

- Sunset harness leather construction with an English toast suede lining for no-slip comfort.
- Wrap around calf with a 4" wide hook and loop strap that offers a perfect fit and distributes pressure evenly.
- Angled leather tunnel allows the climber shank to run securely when combined with the appropriate metal bracket.
- Metal formed plates are not included.
- Insert Not Included
- Sold per pair.

SKU	ATTRIBUTE	PRODUCT
0897175	Leather	4" Velcro Wrap Pads Angled



## Weaver Steel Insert For Buck, Bashlin, Climb Right

### SPECS + FEATURES

- 2" Green Metal Plate Inserts hold Old Buckingham, New Buckingham, Bashlin and Climb Right spike climbers. Our Shin Cup and Climber Pads are now interchangeable with these Metal Plate Inserts.
- Sold per pair.

SKU	ATTRIBUTE	PRODUCT
0897125	Green	2" Steel Insert For Buck, Bashlin, Climb Right



## Weaver Steel Insert For Klein

### SPECS + FEATURES

- 2" Burgundy Metal Plate Inserts hold Klein spike climbers. Our Shin Cup and Climber Pads are now interchangeable with these Metal Plate Inserts.
- Sold per pair.

SKU	ATTRIBUTE	PRODUCT
0897130	Burgundy	2" Steel Insert For Klein



## Spyder Climb Right Ultra Light Velcro Pads

Climb Right's Ultra Light Pads are super-lightweight pads that offer great durability and maximum comfort.

### SPECS + FEATURES

- Replaceable closed foam padding
- Wide Velcro straps for a secure fit
- Pads bolt directly to spurs
- Angular design to minimize discomfort and chafing
- Compatible with Climb Right, Bashlin, and BUCK spurs with included adapters.

SKU	ATTRIBUTE	PRODUCT
90070	Green	Climb Right Ultra Light Velcro Pad





## BUCK Pin Style Replacement Tree Gaff

For use on tree climbers 9309 (straight) and 9509 (offset)



### SPECS + FEATURES

- Measures 2-3/4" (7cm)
- Pin style comes with 4 drive lock pins
- For climbers issued prior to Oct. 2007

SKU	ATTRIBUTE	PRODUCT
9306	2 3/4"	Pin Style Replacement Tree Gaff



## BUCK Pin Style Replacement Pole Gaff

For use on tree climbers 9309 (straight) and 9509 (offset)



### SPECS + FEATURES

- Measures 2-3/4" (7cm)
- Pin style comes with 4 drive lock pins
- For climbers issued prior to Oct. 2008

SKU	ATTRIBUTE	PRODUCT
9206	1 3/4"	Pin Style Replacement Pole Gaff



## BUCK Dowel & Screw Style Replaceable Gaffs



### SPECS + FEATURES

- Replaceable dowel & screw tree gaff for titanium and steel tree climbers.
- Easy to change out.
- Use on climbers issued January 2011 or later.

SKU	ATTRIBUTE	PRODUCT
NB9306	2 3/4"	Dowel & Screw Style Replaceable Gaffs



## BUCK Pole Gaff



### SPECS + FEATURES

- To be used with BUCK T, TB & SB climbers CCA 16 degree angled replaceable dowel & screw pole gaffs
- Easy to change out
- Includes: 2 gaffs and screws
- For Climbers issued Jan. 2011 or later

SKU	ATTRIBUTE	PRODUCT
NB9106A	1 3/4"	Pole Gaff



## Bashlin Replacement Pole Gaffs

Fits the BD14 and BD16B Climbers. The standard 14 gaff is 1 5/8" long.



SKU	ATTRIBUTE	PRODUCT
14	1 5/8"	Bashlin Replacement Pole Gaffs



# climbers + spikes

CLIMBING / CLIMBERS + SPIKES / GAFFS + GAFF GUARDS

## Edelrid Replacement Tree Gaffs



Fits Edelrid Talon Climbers 2 3/4" long.

SKU	ATTRIBUTE	PRODUCT
882970700060	70 mm	Edelrid Replacement Tree Gaffs



## Edelrid Replacement Pole Gaffs



Fits Edelrid Talon Climbers 1 5/8" long.

SKU	ATTRIBUTE	PRODUCT
882960430060	43 mm	Edelrid Replacement Pole Gaffs



## Spyder Quick Change Replacement Tree Gaffs



Replacement gaffs to fit CTB Climbers Quick-Change style gaffs go on & off easily using a 2-screw design, the top screw threads completely through stirrup for visual confirmation the gaff is securely attached Forged from 4340 alloy steel and are quenched and tempered to hold their point

### SPECS + FEATURES

- Spike Length: 2-5/8"
- Overall Length: 4-5/8"

SKU	ATTRIBUTE	PRODUCT
90040	2 5/8"	Spyder Quick Change Replacement Tree Gaffs



## Spyder Quick Change Replacement Pole Gaffs



Replacement gaffs to fit CTB Climbers Quick-Change style gaffs go on & off easily using a 2-screw design, the top screw threads completely through stirrup for visual confirmation the gaff is securely attached Forged from 4340 alloy steel and are quenched and tempered to hold their point

### SPECS + FEATURES

- Spike Length: 1-5/8"
- Overall Length: 3-5/8"

SKU	ATTRIBUTE	PRODUCT
90042	1 5/8" <b>NEW</b>	Spyder Quick Change Replacement Pole Gaffs



## Spyder Replaceable Tree Gaff Set



Replacement gaffs to fit CTB Climbers Set includes everything pictured

### SPECS + FEATURES

- Spike Length: 2-5/8"
- Overall Length: 4-1/2"

SKU	ATTRIBUTE	PRODUCT
85020	2 5/8"	Spyder Replaceable Tree Gaff Set





## Miller Antec AXESS Gaff Replacement Kit



Sold as a pair. Complete with tools

SKU	ATTRIBUTE	PRODUCT
1014993		Antec AXESS Gaff Replacement Kit



## Miller Antec AXESS Gaff Guards



Replacement gaff guards to help protect from undue wear

SKU	ATTRIBUTE	PRODUCT
1014995	Leather/Velcro	Antec AXESS Gaff Guards



## Weaver Gaff Guards



### SPECS + FEATURES

- Universal fits
- Velcro closure

SKU	ATTRIBUTE	PRODUCT
0897100	Leather/Velcro	Weaver Gaff Guards



## BUCK Leather Gaff Guard with Bungee



### SPECS + FEATURES

- Gaff guard that fits all climbers
- Equipped with a bungee strap that attaches to the sleeve loop.

SKU	ATTRIBUTE	PRODUCT
60093	Leather	Bungee Gaff Guard



## BUCK Magnetic Gaff Guard



Feature a strong magnet that keeps the guards securely attached to all manufacturer's pole and tree gaffs

### SPECS + FEATURES

- Length: 1.5"
- Width: 1"
- Magnetic gaffs stay securely on gaffs
- Hi-Vis Green

SKU	ATTRIBUTE	PRODUCT
6909M2		Magnetic Gaff Guard



SUPER CONVENIENT PROTECTION!

## BUCK Universal Tree Gaff Guard



### SPECS + FEATURES

- Coated wire tree gaff guard that is made to fit all BUCK permanent and replaceable gaff climbers as well as Bashlin, Klein, and any domestic tree climbers with a gaff length between 2.5" - 3"

SKU	ATTRIBUTE	PRODUCT
6909TU		Universal Tree Gaff Guard



# climbers + spikes

CLIMBING / CLIMBERS + SPIKES / HARDWARE

## BUCK Tree or Pole Gaff Maintenance Kit

Tools and gauge for inspecting and performing gaff maintenance

### KIT INCLUDES:

- A smooth single cut file (6058)
- A tree gaff gauge (6306) or a new and improved pole gaff gauge (6303), that can now gauge CCA gaffs.
- A finishing hone (6501)
- Features 3 inside pockets.
- 2-way snaps allow for the kit to be rolled and snapped shut.

SKU	ATTRIBUTE	PRODUCT
6025	Pole	Gaff Maintenance Kit
6026	Tree	Gaff Maintenance Kit



BUCKINGHAM  
**BUCK**  
1886

## BUCK Climber Footplates

Compatible with any steel or titanium climber. Two plates, one with a rubber sole that faces down, fasten together on the climber stirrup with two screws

### SPECS + FEATURES

- 9" Length
- 3.5" Width
- Not for use with aluminum climbers.

SKU	ATTRIBUTE	PRODUCT
35033		Climber Footplates



BUCKINGHAM  
**BUCK**  
1886

## BUCK Sleeve Fasteners Threaded

Package of four replacement 10/32 threaded screws for climber sleeves. Designed for use with climbers that have threaded sleeve attachment holes.

SKU	ATTRIBUTE	PRODUCT
996		Sleeve Fasteners Threaded



BUCKINGHAM  
**BUCK**  
1886

## BUCK Smooth Sleeve Fasteners

For smooth climber sleeves Barrel fastener and screw 5 pieces per pack

SKU	ATTRIBUTE	PRODUCT
9215		Smooth Sleeve Fasteners



BUCKINGHAM  
**BUCK**  
1886

## Spyder Climb Right Replacement Sleeves

Climb Right Adjustment Aluminum Climber Sleeves with Screws – Replacement Climb Right Long Short Sleeves

### SPECS + FEATURES

- Includes: Pair and installation screws

SKU	ATTRIBUTE	PRODUCT
85024		Climb Right Replacement Sleeves



Spyder  
MANUFACTURING / USA





# 6 | cutting + pruning

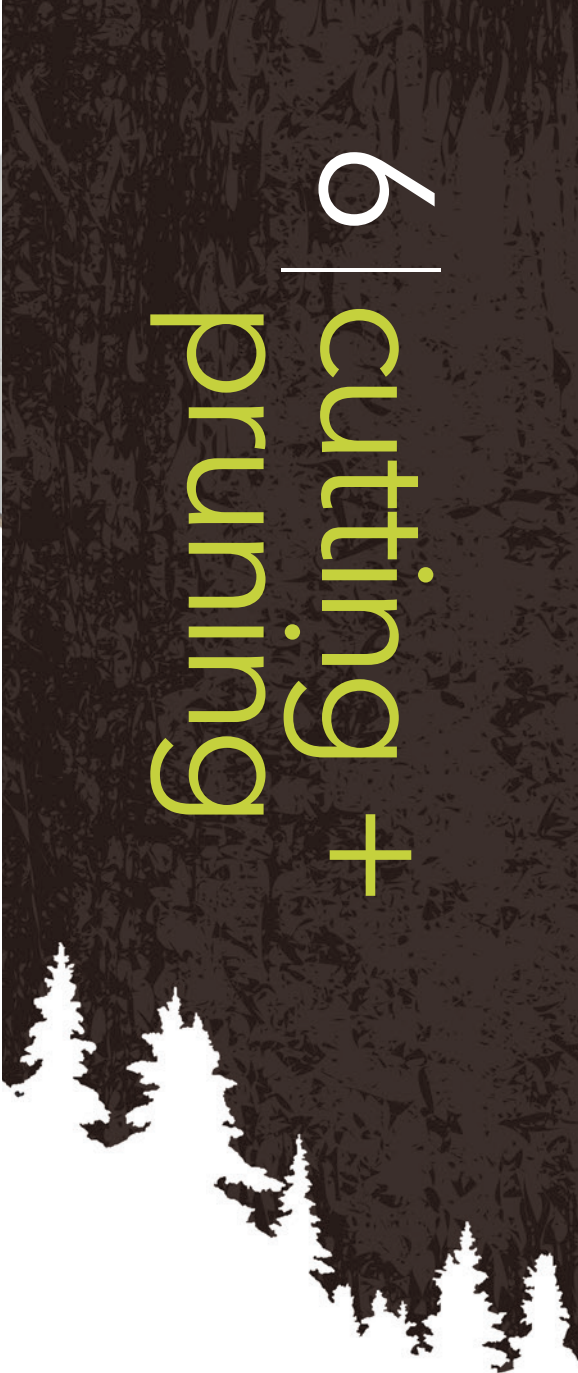

POLE SAWS.....	196
HANSAWS .....	207
HAND PRUNERS .....	213
OTHER CUTTING TOOLS.....	217

Image courtesy of Silky, featuring Silky GunFighter Handsaw  
Silky products not available for distribution in the Florida market

# pole saws

## ARS EXP55C Telescoping 7.1'-18.4' Pole Saw



Light, quick, easy to extend poles let you prune up high without using ladders. The aluminum is super lightweight and easy to maneuver and control. With a unique rectangular shape the poles give you solid stability while sawing.

### SPECS + FEATURES

- Lightweight 7.1'-18.4' long telescoping pole saw with 16" blade with hook, bark cutter, and raker teeth
- Parallel wall construction of pole is strong and minimizes sway
- Hard chrome plated blade
- Poles can be interchanged with other ARS Saw Heads
- Kit Includes (Weight 5.9 lbs): SCEXP55 (Pole) , SAUV40 ((Pole Saw Head and Scabbard)

SKU	ATTRIBUTE	PRODUCT
EXP55C	Kit	Full Telescoping 7.1'-18.4' Pole Saw
SAUV40	Head	Pole Saw Head (blade, head, scabbard)
SCEXP55	Pole	EXP55 Telescoping Pole Saw



## ARS EXP45C Telescoping Pole Saw 6'-15'



### SPECS + FEATURES

- Lightweight 6'-15' long telescoping pole saw with 16" blade with hook, bark cutter, and raker teeth
- Parallel wall construction of pole is strong and minimizes sway
- Hard chrome plated blade
- Poles can be interchanged with other ARS Saw Heads
- Kit includes (Weight 4.1 lbs): SCEXP45 (Pole) , SAUV40 (Pole Saw Head and Scabbard)

SKU	ATTRIBUTE	PRODUCT
EXP45C	Kit	Full Telescoping 6'-15' Pole Saw
SAUV40	Head	Pole Saw Head (blade, head, scabbard)
SCEXP45	Pole	EXP45 Telescoping Pole Saw



## ARS EXP33C Telescoping Pole Saw 4.5'-10.8'



### SPECS + FEATURES

- Lightweight 4.5'-10.8' long telescoping pole saw with 13" blade with hook, bark cutter, and raker teeth
- Parallel wall construction of pole is strong and minimizes sway
- Hard chrome plated blade
- Poles can be interchanged with other ARS Saw Heads
- Kit includes (Weight 4.2 lbs): SCEXP33 (Pole) and SAUV34EXP (Pole Saw Head)

SKU	ATTRIBUTE	PRODUCT
EXP33C	Kit	Full Telescoping 6'-15' Pole Saw
SAUV34EXP	Head	Pole Saw Head (blade and head)
SCEXP33	Pole	EXP33 Telescoping Pole Saw





## Jameson Double Lock™ Telescoping Pole Saw

**Double Lock Telescoping Pole** offers a pole length of 6-12' with a permanently mounted pole saw head and a 13" tri-cut saw blade (SB-13TE). **Jameson**, the leader in fiberglass poles, brings you a high quality, lightweight pole that saves space and adjusts to fit your job.

### SPECS + FEATURES

- Double locks (internal lock and external cap) ensure poles will not collapse, offering a secure connection at any length for maximum versatility and safety
- Lightweight, durable fiberglass will not crimp under high stress like aluminum poles
- Compact for easier climbing and storage

Not a "hot stick"

SKU	SIZE	ATTRIBUTE	PRODUCT
TP12S	12'	Telescoping	Double Lock Telescoping Pole, 6-12'
SB-13TE	13"		Saw Blade Tri-Cut



## Jameson FG Pole Pruner - Pole Saw Kit

This **Jameson Tree-Trimming FG Pole Pruner - Pole Saw Kit** has a pole adapter that helps permit quick and easy replacement of the pruner head or pole saw, without tools, if using the same pole.

### SPECS + FEATURES

- The kit includes
  - JA-14 Pruner with Adapter and Pruner Rope
  - One 13" Tri-Cut Saw Blade (SB-13TE)
  - One Pole Saw Head
  - One 6' FG Hollow Extension Pole
  - One 6' FG Base Pole.
- This fixed pulley side-cut pruner is ideal for clearing away tree branches in the path of CATV or telecommunications aerial lines.

Not a "hot stick"

SKU	SIZE	ATTRIBUTE	PRODUCT
FG6-PKG-1	12'		FG Pole Pruner Kit Pole, 6-12'
SB-13TE	13"		Saw Blade Tri-Cut



# pole saws

CUTTING + PRUNING / POLE SAWS

## The Lightning Stik™ EXCLUSIVE PRODUCT

Carbon fiber pruning poles - seriously they're that light at 3 oz. per foot! If you have to use a pole saw, be good to yourself. At 3.6 lbs per 16' this is a true game changer. Strong enough for a pull-up, but light enough to use for hours.

### SPECS + FEATURES

- Tri-Lobe designed pole for a greater control with reinforced twill joints & outer wrap and solid stainless steel snap buttons
- Almost 16' reach without the flex, wiggle or wobble of a fiberglass pole
- Great for palm pruning, removing a hanger, or for extended Pole Saw work.
- Excellent for foresters doing TSI work too!
- INCLUDES:  
(2) x LS70 poles (70") *Additional poles available (sold separately)*  
(1) x LS35 pole (35") *Additional poles available (sold separately)*  
Head with hook  
ARS CT32E 13" saw blade  
Weaver Pole Saw Scabbard
- Designed to be used with ARS saw blades

NOTE: Not to be used around electrical wires.

SKU	SIZE	ATTRIBUTE	PRODUCT
Full Pole Saw Kit	16'	Sectional	Carbon Fiber Pole Saw Kit

IMPRESSIVELY LIGHT, RIGID, AND PRECISE.



## Fred Marvin Professional Series Pole Saw/Pruner Kit



Professional series pole saw that features a quick change pruner head and a quick change saw head.

### SPECS + FEATURES

- Deluxe Pruning Package Features:  
A Quick Change Pruner Head  
A Quick Change Saw Head With S-120 Blade  
6' Mid-Pole  
6' Base Pole  
Rope
- Professional Series Pole Saw features Extra Stiff Pole, Reinforced Spring Clip, and Heavy Duty Rubber End Cap

SKU	SIZE	ATTRIBUTE	PRODUCT
PKG-23B	12'	Kit	Professional Series Pole Saw/Pruner Kit



## Jameson LS Series Landscaper Poles



LS Series fiberglass poles are economical, lightweight and versatile; ideal for landscapers and homeowners.

### SPECS + FEATURES

- Hollow Core
- Wall Thickness: .10"
- Pole Diameter: 1.25"
- Length: 6 ft

SKU	SIZE	ATTRIBUTE	PRODUCT
LS6	6'	Green	LS Landscaper Extension Pole
LS6F	6'	Green	LS Landscaper Base Pole



## Jameson B Lite Fiberglass Poles/Extensions



Jameson's thinnest walled pole is lightweight and easy to control, making it ideal for tree trimming. Its lighter weight results in less fatigue during extended work periods and easier handling. Durable, high gloss enamel coating for long life, easy cleaning, and prevention of fiber bloom.

### SPECS + FEATURES

- Hollow core
- Wall Thickness: .075"
- Pole Diameter: 1.25"
- Batch tested to 100KV per foot for 5 minutes

Not a "hot stick"

SKU	SIZE	ATTRIBUTE	PRODUCT
BL6F	6'	Blue	Bl Series Base Pole
BL8F	8'	Blue	Bl Series Base Pole
BL10F	10'	Blue	Bl Series Base Pole
BL12F	12'	Blue	Bl Series Base Pole
BL6	6'	Blue	Bl Series Extension Pole
BL8	8'	Blue	Bl Series Extension Pole
BL10	10'	Blue	Bl Series Extension Pole





## Jameson FG Series Pruner Poles



Use **Jameson FG Series Pruner Poles** for highest performance and safety, Jameson recommends using a base pole when using one pole or starting with a base pole when working with multiple poles. Add a compatible **FG Extension Pole** with male and female ferrules provides additional length, extending workable height. Lighter than the JE series, offering greater control and exceptional bending strength.

### SPECS + FEATURES

- Hollow Core
- Wall Thickness: .125"
- Pole Diameter: 1.25"
- Batch tested to 100KV per foot for 5 minutes

Not a "hot stick"

SKU	SIZE	ATTRIBUTE	PRODUCT
FG3F	3'	Yellow	FG Series Base Pole
FG4F	4'	Yellow	FG Series Base Pole
FG6F	6'	Yellow	FG Series Base Pole
FG12F	12'	Yellow	FG Series Base Pole
FG3	3'	Yellow	FG Series Extension Pole
FG4	4'	Yellow	FG Series Extension Pole
FG6	6'	Yellow	FG Series Extension Pole
FG-8	8'	Yellow	FG Series Extension Pole
FG10	10'	Yellow	FG Series Extension Pole
FG-12	12'	Yellow	FG Series Extension Pole

LIGHTER THAN  
THE JE SERIES



## Jameson JE Foam Core Base Pole/Extensions



Jameson's original foam core pole is the highest quality fiberglass pole available.

### SPECS + FEATURES

- Foam core prevents debris and moisture build up inside pole and adds extra hoop strength and rigidity.
- Fits: most Jameson saw heads and pruner heads
- Wall thickness: .110"
- Pole Diameter: 1.25"
- Weight: 2.6 lbs
- Meets requirements of OSHA Subpart R 1910.269 (j)(1)(i): Individually tested to 100KV per foot for 5 minutes

Not a "hot stick"

SKU	SIZE	ATTRIBUTE	PRODUCT
JE6F	6'	Lime	JE Foam Core Base Pole (Female)
JE3	3'	Lime	JE Foam Core Extension Pole
JE4	4'	Lime	JE Foam Core Extension Pole
JE6	6'	Lime	JE Foam Core Extension Pole
JE-8	8'	Lime	JE Foam Core Extension Pole
JE6M	6'	Lime	JE Foam Core Extension Pole (Male)
JE6BM	6'	Lime	JE Foam Core Bottom Pole



## Jameson Telescoping Pole 12'



**Jameson Telescoping Pole** is a leader in fiberglass poles. Jameson brings you a high quality, lightweight telescoping pole that adjusts to fit your job.

### SPECS + FEATURES

- Double locks (internal lock and external cap) ensure poles will not collapse, offering a secure connection at any length for maximum versatility and safety.
- Lightweight, durable fiberglass will not crimp under high stress
- Telescoping Pole: 6-12'
- Female Ferrule

SKU	SIZE	ATTRIBUTE	PRODUCT
TP-12F			Telescoping Pole 12'



## Jameson JEC CompositLock Poles



Jameson's New JEC Foam Core CompositLock Base Pole

SKU	SIZE	ATTRIBUTE	PRODUCT
JEC-6F	6'	FOAMCORE	JEC CompositLock Base Pole
JEC-6	6'	FOAMCORE	JEC CompositLock Extension Pole



## Jameson CompositLock FGC Base Pole



Jameson's New FGC Hollow Core CompositLock Base Pole

SKU	SIZE	ATTRIBUTE	PRODUCT
FGC-6F	6'	HOLLOW	CompositLock FGC Base Pole
FGC-6	6'	HOLLOW	CompositLock FGC Extension Pole



## Fred Marvin Pro Series Fiberglass Poles



Hollow core fiberglass poles are lightweight and extremely durable

### SPECS + FEATURES

- 0.125" wall thickness
- Female ferrule features a heavy duty spring clip
- Base pole features heavy duty rubber foot

SKU	SIZE	ATTRIBUTE	PRODUCT
6FB	6'	Base	Pro Series Fiberglass Poles
6FM	6'	Mid	Pro Series Fiberglass Poles



# pole saws

CUTTING + PRUNING / POLE SAW BLADES

## ARS Pole Saw Blade with Tuttle



Blade is tri-cut sharp, well made and sturdy. A go-to Pole Saw replacement blade that lasts and doesn't "bend" in the cut.

### SPECS + FEATURES

- Length: 13"
- Blade Style: Curved

SKU	SIZE	ATTRIBUTE	PRODUCT
SBUV341	13"	Curved	Pole Saw Repl. Blade with Tuttle



ALL ARS BLADES ARE INTERCHANGEABLE!

## ARS Signature Series Pruning Saw Replacement Blade



Replacement Blade for ARS Signature CT32E Series Pruning Saw.

### SPECS + FEATURES

- Blade Style: Curved
- Blade Length: 13"

SKU	SIZE	ATTRIBUTE	PRODUCT
SBCT32E1	13"	Curved	Signature CT32E Replacement Blade



## ARS Super Turbocut Blade



One of the best blades in the industry! ARS pole saw blades start razor sharp and stay that way an extra long time – longer than any of the competitors. The **super turbocut blade** includes raker teeth to remove debris during the cut.

### SPECS + FEATURES

- 13" strip steel super turbocut blade with raker teeth
- Marquench hardened for long lasting sharpness
- Chemical nicked for superior rust and sap resistance
- Multipurpose hole pattern

SKU	SIZE	ATTRIBUTE	PRODUCT
SB-UV321	13"		Replacement Blade



## ARS Turbo Curved Blade



### SPECS + FEATURES

- Marquench hardened for long lasting sharpness
- 13" Strip steel turbocut curved blade
- Chemical nicked for superior rust and sap resistance
- Multipurpose hole pattern
- Tooth pitch: 4 mm

SKU	SIZE	ATTRIBUTE	PRODUCT
SB-CT321	13"	Curved	Turbo CT321 Curved Blade 13"

ALL ARS BLADES ARE INTERCHANGEABLE!



## ARS Turbocut Pole Saw Blade with Hook



The hook is handy when removing limbs and branches.

### SPECS + FEATURES

- 13" strip steel turbocut blade
- Marquench hardened for long lasting sharpness
- Chemical nicked for superior rust and sap resistance
- Hook for removing branches and limbs
- Multipurpose hole pattern

SKU	SIZE	ATTRIBUTE	PRODUCT
SBCT341	13"		Turbocut Pole Saw Blade 13"



## Jameson Barracuda Saw Blade SB-13TE



Provides a quicker, cleaner cut with less wear on the blade than traditional blades.

### SPECS + FEATURES

- Fits Jameson PS-3FP Pole Saw Head, SB-UC Universal Saw Blade Adapter and Handsaw Handles.
- Hard-chrome plated
- 13" Tri-cut blade
- Long-lasting edge

SKU	SIZE	ATTRIBUTE	PRODUCT
SB-13TE	13"		Saw Blade Tri-Cut





## Jameson Barracuda Tri-Edge Saw Blade



Provides a quicker, cleaner cut with less wear on the blade than traditional blades.

### SPECS + FEATURES

- Fits Jameson PS-3FP Pole Saw Head, SB-UC Universal Saw Blade Adapter and Handsaw Handles.
- Hard-chrome plated
- 16" Tri-Cut Saw Blade
- Long-lasting edge

SKU	SIZE	ATTRIBUTE	PRODUCT
SB-16TE	16"		Saw Blade Tri-Edge



Kyle McCabe, Certified Arborist  
Northern Arboriculture

## Jameson Saw Blade with Hook



Jameson Steel Tri-Cut blades cut quicker and cuts clean.

### SPECS + FEATURES

- Steel, Hard chrome plated
- Blade length: 13"

SKU	SIZE	ATTRIBUTE	PRODUCT
SB-13TE-H	13"		Saw Blade w/Hook



## Fred Marvin 330 Tri-Edge



Designed and built to meet the rigid requirements of tree service professionals.

### SPECS + FEATURES

- Tri-Edge razor sharp cutting edge
- Hook helps hold blade in cut

SKU	SIZE	ATTRIBUTE	PRODUCT
S20	13"		330 Tri-Edge Pole Saw Blade
S21	13"		330 Tri-Edge w/Hook



## Fanno 1311 Replacement Blade



Mounts on both popular 1311 handsaw and on most Pole Saw heads

SKU	SIZE	ATTRIBUTE	PRODUCT
FI13S-B	13"		1311 Replacement Blade



## Fanno 1700 Replacement Blade



Mounts on both 1700 Handsaw and most Pole Saw heads **Fanno FI-1700 15"** Replacement Blade

Curved blade features 6 tri-edge razor teeth per inch for cleaner, faster cuts, saving time and labor.

SKU	SIZE	ATTRIBUTE	PRODUCT
FI-17SB	15"		1700 Replacement Blade



CUTTING + PRUNING / POLE SAW HEADS

## Jameson Aluminum Pole Saw Head Adapter



### SPECS + FEATURES

- Make your Pole Saw head quick release
- Fits: FG, JE, and BT series fiberglass poles
- Includes: Adapter only

SKU	SIZE	ATTRIBUTE	PRODUCT
PS-3FP			JE Pole Saw Head Adapter



## Jameson JE Pole Saw Adapter Kit



Turn your **Jameson** Pole Saws into a saw pruning pole. Head inserts to all **Jameson** series poles.

### SPECS + FEATURES

- Chrome 13" Tri-cut Saw Blade Kit
- Aluminum Pole Saw Head
- Includes: Pole Saw Adapter, Pole Saw blade

SKU	SIZE	ATTRIBUTE	PRODUCT
PS3FPS1			Jameson JE Pole Saw Adapter Kit



## Jameson Cable Lifter



**Jameson's Cable Lifter** is a steel plated tool designed for laying up strand, telephone cable and coaxial cable. Also can be used for moving limbs and branches. Fits into female ferrule of fiberglass extension pole.

SKU	SIZE	ATTRIBUTE	PRODUCT
WR1			Jameson Cable Lifter



## Jameson Ferrule BF Pole



Makes it easy to change from a pruner head to pole saw head or pole lengths of 6-12'. The exterior leaf spring locking button on the ferrule offers a strong connection, whether attaching poles or tool heads. This versatility saves time and money in the field.

SKU	SIZE	ATTRIBUTE	PRODUCT
BFF			Ferrule Female BF Pole
BFM			Ferrule Male BF Pole



BFF



BFM

## Jameson 1-1/4" Female Coupler



Female ferrule for **Jameson** fiberglass poles

SKU	SIZE	ATTRIBUTE	PRODUCT
FGF	1-1/4"		1-1/4" Female Coupler





### Jameson Universal Tool Adapter UA-1



**SPECS + FEATURES**

- Adapts any manufacturer's universal head tools to Jameson poles.
- Allows direct mounting of saw blade to pole without saw head.
- Using SB-UC and UA-1 adapters the saw blade unit snaps directly onto pole's ferrule.

SKU	SIZE	ATTRIBUTE	PRODUCT
UA-1			Universal Tool Adapter UA-1



### Jameson Quick Release Adapter Head



**SPECS + FEATURES**

- Make your pruner head "Quick release" by adding this adapter between your pole and the pruner head.
- Makes it easy to change from a pruner head to pole saw head or pole lengths of 6-12'.
- Exterior leaf-spring locking button on the ferrule offers a strong connection, whether attaching poles or tool heads saving time and money in the field.
- Has eye for tying pruner cord for pulley version pruner heads.

SKU	SIZE	ATTRIBUTE	PRODUCT
PHA14			PH-14 Pruner Adapter
PHA16			PH-16 Pruner Adapter

PHA14



PHA16



### Fred Marvin Quick Change Pole Saw Head



**SPECS + FEATURES**

- An assortment of saw blades attach to the head via a bolt and wing nut (blade not included)
- Fits all Marvin poles with a female ferrule (base and mid poles)
- Includes quick change saw head with adapter

SKU	SIZE	ATTRIBUTE	PRODUCT
QCS			Quick Change Pole Saw Head



### Fred Marvin Pole Ferrule Couplings



Couplings for fiberglass and octagonal wood poles. Aluminum extension couplings to connect two round or octagonal poles

**SPECS + FEATURES**

- Both couplings are locked by a spring clip that is easily controlled with thumb and forefinger
- Z126 – Complete set male and female ferrules with spring clip

SKU	SIZE	ATTRIBUTE	PRODUCT
Z126		Set	Pole Ferrule Couplings
Z126F		Female	Pole Ferrule with spring clip
Z126M		Male	Pole Ferrule with spring clip

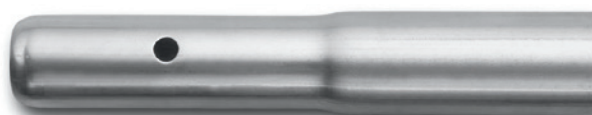

# pole saws

CUTTING + PRUNING / POLE PRUNER HEADS

## Jameson Fixed Pulley Pruner Head



Features a removable upper spring pin and blade bolt for easy blade replacement and sharpening.

### SPECS + FEATURES

- Forged steel components for added strength
- Enhanced spring for smoother cutting action
- Raised hook edge reduces blade drag
- Fixed pulley
- Cutting capacity: 1.25"
- PH-14 Pruner Head Package includes Pruner Head, Rope, Adapter

SKU	SIZE	ATTRIBUTE	PRODUCT
JA14S			JA-14 w/Swivel
JA14			JA-14 Fixed
PH14PKG			JA-14 Package
JAZ104			Replacement Spring JA-14



PH14PKG

## Jameson Big Mouth Double Pulley



The **Big Mouth Pruner** features a double pulley and included adapter. It has the same heavy duty construction of the JA-14 with a large 1.75" hook opening and a removable upper spring pin and blade bolt for easy blade replacement.

### SPECS + FEATURES

- Forged steel components for added strength
- Enhanced spring for smoother cutting action
- Raised hook edge reduces blade drag
- Cutting capacity: 1.75"
- P34A includes Pruner Head and adapter (PHA-14).
- JA34DP-PKG includes: Pruner Head, adapter (PHA-14), and rope (PR-20)

SKU	SIZE	ATTRIBUTE	PRODUCT
JA-34DP			Big Mouth Double Pulley
P34A			JA-34 Big Mouth Kit with Adapter
JA34DP-PKG			JA-34DP Package
PH-34PKG			JA-34 Big Mouth Package
JBM104			Replacement Spring JA-34
JAZ101			Replacement Blade JA-34

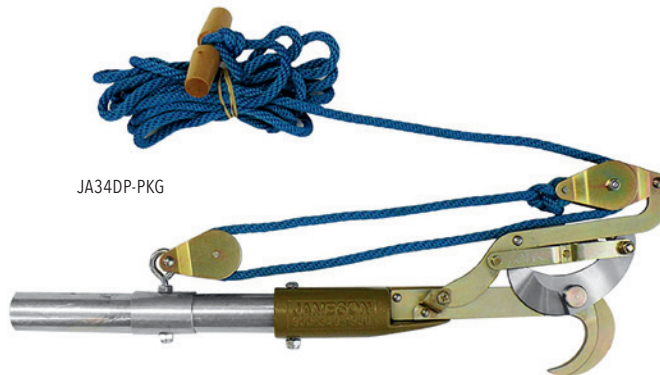

JA34DP-PKG

## Jameson CompositLock Pole Saw Head Package



Jameson CompositLock Poles maintain insulating properties across pole sections for line-clearance tree work PLUS offer more secure pole connection for telecommunication, line clearance, arborist and landscape professionals.

### SPECS + FEATURES

- Sharpened upper hook prevents pulling out of cut and quickly removes suckers or vines
- Sharpened lower hook scores bark to prevent ripping damage to branch collar
- Tri-cut edge provides a quicker, cleaner cut with less wear on the blade than traditional blades
- Hard-chrome plated with impulse hardened teeth for long life
- Includes Pole Saw Head & Double Hook Blade

SKU	SIZE	ATTRIBUTE	PRODUCT
PSC-3FPK-16DH			CompositLock Saw Head Package
PSC-3FP			CompositLock Adapter



## Jameson WRC-1 Limb & Wire Raiser with CompositLock™ Ferrule



Places cable on rollers, construction blocks and hardware during line construction. Conveniently pulls or lifts branches out of dense foliage. **CompositLock** ferrule.

### SPECS + FEATURES

- Place cable during line construction
- Pull or lift branches
- Not for use on or near live wires.
- For use with Jameson CompositLock poles
- Fits: New composite poles only

SKU	SIZE	ATTRIBUTE	PRODUCT
WRC-1			CompositLock Wire Raiser





### Fred Marvin Quick Change Pruner Head

Quick change pruner head with adapter

**SPECS + FEATURES**

- 1-1/4 inch cut pruner head with adapter
- Will fit PKG-23B

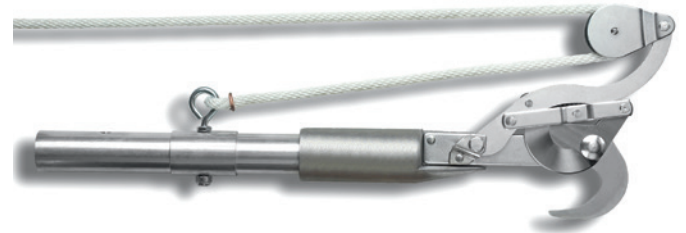

SKU	SIZE	ATTRIBUTE	PRODUCT
QCP	1 1/4"		Quick change pruner head

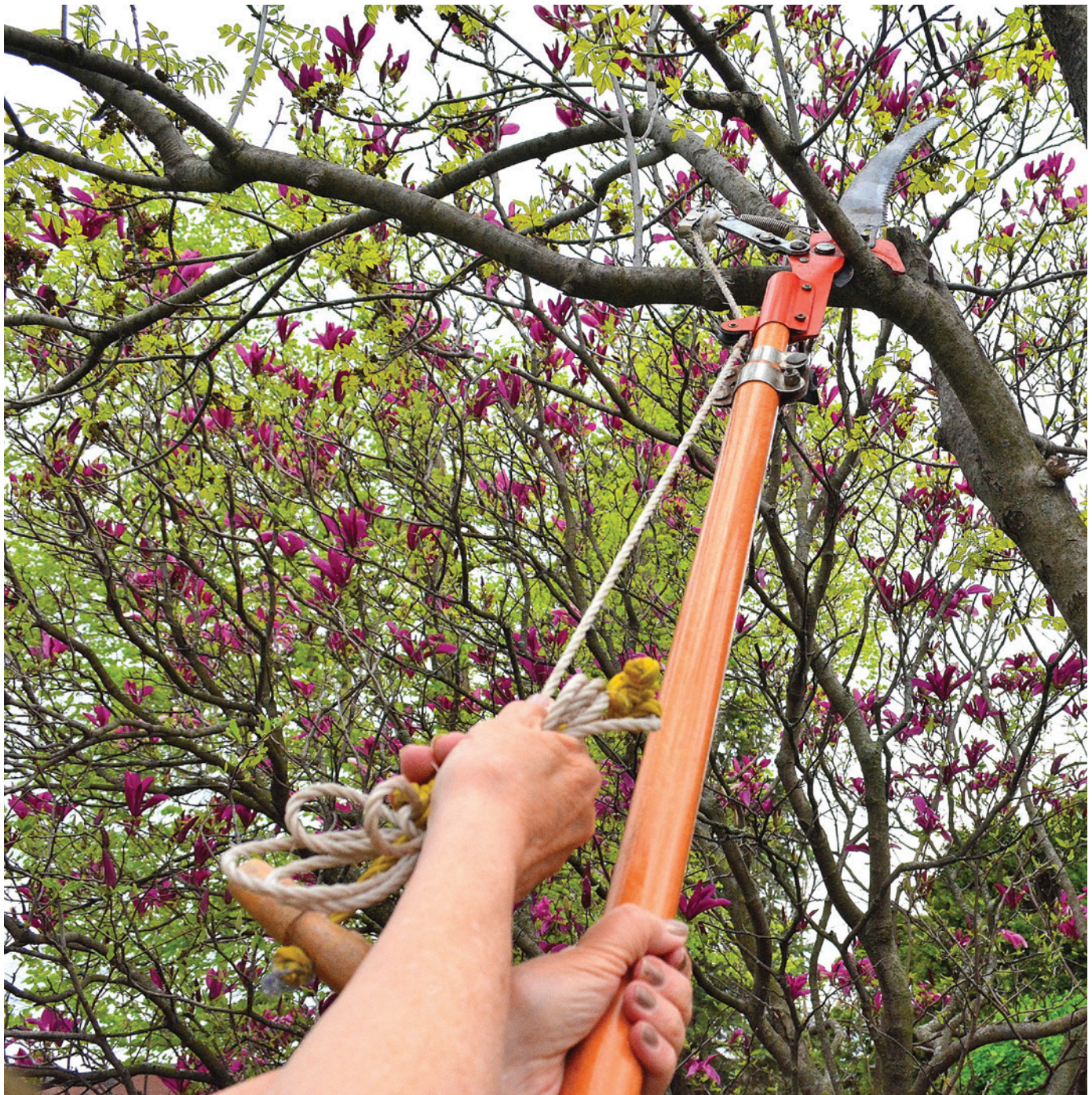



## Weaver Pole Saw Belted Scabbard



### SPECS + FEATURES

- Features an 18" long strap with eight hole adjustments
- Features a clip and d-ring for easy attachment to saddle
- Constructed from black rubberized belting
- Nickel plated D ring for securing scabbard
- Secures to blades with a 5/8" wide strap made from black top grain leather
- Fits saws 13-17" – Will accommodate the Fanno #FI-17s-B and ARS Super Turbocut CT-34 Hook Blade Saw, Fanno #Fi-1125S-B, Seymour Smith #20-B, Bartlett mfg. #4402 and all Fred Marvin pole saws



SKU	SIZE	ATTRIBUTE	PRODUCT
0803025	15 1/2"		Pole Saw Scabbard Belted
08-03027	17"		Pole Saw Scabbard Belted

## Weaver Leather Pole Saw Scabbard



### SPECS + FEATURES

- Constructed of lock-stitched and riveted top grain steer hide harness leather
- Features a clip and d-ring for easy attachment to saddle
- Secures to blades with a 5/8" wide strap made from black top grain leather
- Will accommodate the Fanno #FI-1125s-B, Seymour Smith #20-B and Bartlett Mfg. #4402 and features an 18" long strap with eight hole adjustments (maximum 3-1/2" opening).
- Large openings on side and bottom for easy clean out.



SKU	SIZE	ATTRIBUTE	PRODUCT
0802025	15 1/2"		Pole Saw Scabbard Leather

## Weaver Pole Saw Scabbard Belted



### SPECS + FEATURES

- Constructed of lock stitched and riveted black
- Rubberized belting
- Nickel plated D ring for securing scabbard to saddle, allowing for travel aloft
- Scabbards have an open end for sawdust real ease and a 5/8" wide leather strap that secures it to saw
- Features a clip and d-ring for easy attachment to saddle
- Overall length: 17.5"
- Fits Fanno: #5s-b, #57s-b and #9-b
- Strap closure: 14" strap with eight hole adjustments (maximum 4" opening)



SKU	SIZE	ATTRIBUTE	PRODUCT
08-03023	17 1/2"		Pole Saw Scabbard Belted

### Arborist hand saw

Arborist hand saws are specially designed to cut through green wood 1/2 inch to 3 inches in diameter. Many arborists hand saws cut mostly on the pull stroke, with curved blades. Some cut on both the pull and push stroke. A large variety of sizes and designs are available to suit your needs. Always use a scabbard to stow a hand saw when not in use. Before climbing, be sure the scabbard can be turned upside down without the hand saw coming out.



Educational Arborist Hand Saws courtesy of TCIA ; illustrations by Bryan Kotwica



# handsaws

## Silky ZÜBAT Handsaw



Hands down the best-selling, professional, heavy-duty handsaw. Comes with a curved, mono-constructed blade. Great saw for arborists pruning in trees, aloft or on the ground. Large enough for softer hardwoods up to 10" in diameter (you're gonna work, but not be hating life). This saw will make you go ahhh.

### SPECS + FEATURES

- Curved blade provides greater cutting speed with less effort. Utilizes proprietary Silky MIRAI-ME (Smooth Cutting) Technology.
- The precision-ground, razor sharp blade with four cutting angles provide fast, clean and extremely smooth cutting action.
- The hard chrome-plated blade has 6.5 teeth per inch, resists rust and effects of tree resin, and wipes clean easily.
- Molded-rubber handle holds the high-performance fast-cutting curved blade that fits securely inside its custom-fitted, pivoting, black polypropylene sheath with detachable belt holder.
- Teeth configuration: 6.5 teeth per inch (7.5 teeth per 30 mm)

Silky products not available for distribution in the Florida market.

SKU	SIZE	ATTRIBUTE	PRODUCT
27027	270 mm	Curved	ZÜBAT Handsaw
27030	300 mm	Curved	ZÜBAT Handsaw
27033	330 mm	Curved	ZÜBAT Handsaw
27039	390 mm	Curved	ZÜBAT Handsaw
271-27	270 mm	Curved	ZÜBAT Replacement Blades
271-30	300 mm	Curved	ZÜBAT Replacement Blades
271-33	330 mm	Curved	ZÜBAT Replacement Blades
271-39	390 mm	Curved	ZÜBAT Replacement Blades



## Silky SUGOI Professional Arborist Saw



This professional arborist saw has a razor-sharp edge and an ultra-fast curved blade. Perfectly balanced, rugged, one piece construction with a large precision cut tooth.

### SPECS + FEATURES

- Professional saw with a razor-sharp and ultra-fast blade
- Hard-chrome plating
- Includes a custom high-visibility plastic scabbard that can be attached to the belt or leg. Scabbard has a roller on the outside edge where the teeth would normally rub, this helps it from being worn out from putting the saw in and out.
- Teeth per inch: 5.5+

Silky products not available for distribution in the Florida market.

SKU	SIZE	ATTRIBUTE	PRODUCT
390-33	330 mm	Curved	SUGOI Saw
39036	360 mm	Curved	SUGOI Saw
390-42	420 mm	Curved	SUGOI Saw
391-33	330 mm	Curved	SUGOI Replacement Blade
391-36	360 mm	Curved	SUGOI Replacement Blade
391-42	420 mm	Curved	SUGOI Replacement Blade



## Silky IBUKI Handsaw



The **IBUKI Saw** was one of the first **Silky** saws to be introduced in the US and has remained as one of the most popular. Great for pruning large branches.

### SPECS + FEATURES

- Heavy-duty
- Curved 390 mm length blade
- Comfortable rubber handle
- Blade can be used on the HAYAUCHI pole saw
- Sheath included

Silky products not available for distribution in the Florida market.

SKU	SIZE/ATTRIBUTE	PRODUCT
27539	390 mm	Curved - IBUKI Saw
27639	390 mm	Curved - IBUKI Replacement Blade



# handsaws

CUTTING + PRUNING / HANDSAWS

## Silky GOMTARO Pruning Saw



The **GOMTARO** is a beautifully balanced straight pruning saw with an 11-1/2", ultra-strong, mono-constructed blade. Exceptional design, strength, balance and superior finish quality. Ideal for all pruning tasks including root pruning; but best known for finishing removal cuts so an arborist can safely stow their chainsaw before chunking down a big piece of wood.

### SPECS + FEATURES

- Rust-resistant, hard chrome-plated, taper-ground blade with an impulse-hardened non-set tooth design for greater cutting efficiency.
- Utilizes proprietary Silky MIRAI-ME (Smooth Cutting) Technology.
- The razor-sharp teeth with 4 cutting angles provide fast and smooth cutting action.
- High performance blade with an integrated non-slip cushioned comfort rubber handle that really sticks in your hands.
- Comes with a durable black polypropylene scabbard and belt clip.

Silky products not available for distribution in the Florida market.

SKU	SIZE	ATTRIBUTE	PRODUCT
10230	300 mm	Straight	GOMTARO Saw
10227	270 mm	Straight	GOMTARO Saw
103-30	300 mm	Straight	GOMTARO Replacement Blades
103-27	270 mm	Straight	GOMTARO Replacement Blades



## Silky GunFighter Curved Saw



Meet the **GunFighter** - cut larger wood, faster. The same trusted **Silky** name but new design. The **GunFighter** design combines taper grinding, progressive teeth, and new Electroless Nickel Plating (ENP).

### SPECS + FEATURES

- Includes heavy-duty scabbard with patented dual roller locking mechanism and can be worn either side with carabiner or belt
- 4 cutting angles: Straight cut, Rip-cut, cross-cut, or slant cut. (6 teeth/30 mm to 8.5 teeth/30 mm) are finer near the handle and get progressively larger
- Blade is taper ground to reduce resistance yielding a smoother, easier, faster cutting performance
- Impulse hardened stays sharper, longer
- Electroless nickel plating superior wear and rust resistant
- Rubber Handle comfortable, reduces vibration, excellent grip when wet or cold
- Change out your blade with a pull of a trigger, no need for tools.

Note: GunFighter blade must be kept clean to maintain its efficiency. Dissolves sap and resin in olive oil, which is an effective and environmental friendly way to maintain the blade.

Silky products not available for distribution in the Florida market.

SKU	SIZE	ATTRIBUTE	PRODUCT
730-33	330 mm	Curved	GunFighter Saw
731-33	330 mm	Curved	GunFighter Replacement Blade



## Silky PocketBoy Saws

Known for their great cutting capabilities the **PocketBoy** line are a compact, and lightweight folding saw with 6-3/4-inch blade. It's been nicknamed as "Little Giant."

### SPECS + FEATURES

- Blade locks securely into one of two open positions, in line with the handle.
- Resists the effects of tree resin and easily wipes clean.
- Non-slip rubberized handle provides a sure and comfortable grip.
- Comes in a clear plastic flip-lock carrying case with belt clip is included.
- 2 blade lengths are interchangeable blades within the same blade length.
- 4 tooth configurations (TPI - teeth per inch): 7 TPI - Large/Coarse (pruning, green wood), 8.5 TPI - Medium (soft wood), 17 TPI - Fine (hard wood, bamboo), and 22 TPI - Extra Fine (dry hard wood/carpentry).
- Color-coded handle associated with the teeth configuration: Red - Large teeth, Black - Medium teeth, Yellow - Fine teeth, and Purple - Extra Fine teeth.
- Clear plastic flip-lock carrying case with belt clip is included
- Limited lifetime warranty against defects in material and workmanship

Silky products not available for distribution in the Florida market.

SKU	SIZE	ATTRIBUTE	PRODUCT
34013	130 mm	Folding	PocketBoy Saw
34617	170 mm	Folding	PocketBoy Saw
34213	130 mm   5"	Straight Fine	PocketBoy Saw
34017	170 mm   7"	Straight Med	PocketBoy Saw
343-13	130 mm	Fine	PocketBoy Replacement Blade
341-17	170 mm	Med	PocketBoy Replacement Blade
347-13	130 mm	Large	PocketBoy Replacement Blade





## Silky TSURGI Straight Saw



Silky TSURGI medium tooth, straight handsaw – 270 and 300 mm – Versatile slim handsaw; great for pruning in tight places or using on dry hard wood.

### SPECS + FEATURES

- Easily prune even in dense locations and complicated branches
- The handle (genki grip) shape makes replacing blades easy
- Ambidextrous scabbard with fast action rollers
- TSURGI series are interchangeable as within straight or curved family
- Hardened steel blade tip
- Tooth size: Medium, straight blade

Silky products not available for distribution in the Florida market.

SKU	SIZE	ATTRIBUTE	PRODUCT
45227	270 mm   8"	Straight Med	TSURGI Saw
45230	300 mm   12"	Straight Med	TSURGI Saw
453-20	200 mm	Straight Med	TSURGI Replacement Blade
453-30	300 mm	Straight Med	TSURGI Replacement Blade
453-40	400 mm	Straight Med	TSURGI Replacement Blade
451-30	300 mm	Straight Lg	TSURGI Replacement Blade

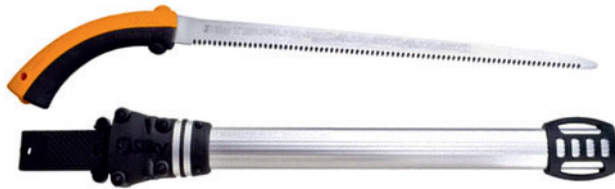

## ARS Pro 13" Curved Arborist Saw with Scabbard

The ARS Professional Series Arborist Saws are by far the finest pruning saws we've seen on the market today. The CT32PRO has a 19" overall length with a 13" long precision ground and impulse hardened Japanese Steel blade for an incredibly sharp edge that lasts 3 times longer than any other blade type. The pull cut sawing action is fast, smooth and incredibly efficient producing a finished cut so perfectly smooth it appears to be planed.

### SPECS + FEATURES

- Scabbard features a safety lock with a thumb trigger release and patented roller technology that allows quick and easy release and stow.
- Precision ground, impulse hardened Japanese high carbon steel blade
- Turbocut tri-edged tooth design
- Hard chrome plated to resist rust and sap
- Rubber padded handle angled for comfortable use

SKU	SIZE	ATTRIBUTE	PRODUCT
SACTR32PRO	13"	Curved	CT32PRO Saw
SBCT32PRO1	13"	Curved	CT32PRO Replacement Blade



## Silky TSURGI Curved Handsaw



### SPECS + FEATURES

- Lightweight design doesn't need screws, nuts or hardware
- Can be attached to your leg or belt for convenient access
- Aggressive blade comes in a variety of popular sizes

Silky products not available for distribution in the Florida market.

SKU	SIZE	ATTRIBUTE	PRODUCT
45427	270 mm   10.5"	Curved Lg	Tsurgi Saw
45633	330 mm   13"	Curved Med	Tsurgi Saw
455-27	270 mm	Curved Lg	TSURGI Replacement Blade
455-33	330 mm	Curved Med	TSURGI Replacement Blade



## ARS Signature Series Professional Arborist Saw

Signature Series Arborist Saws feature a rubber-padded grip design for non-slip grip and ultimate comfort. The blade is hard chrome plated for rust and sap resistance, and the teeth are impulse hardened for maximum strength and durability. Everything you need in a high quality pruning saw!

Includes a reversible belt scabbard for easy access from left or right side with patented roller technology to allow the blade to slide in and out without damaging the scabbard.

### SPECS + FEATURES

- Impulse hardened teeth stay sharp 3 times longer
- Blade Type: Tri-Edge
- Sharpenable: No

SKU	SIZE	ATTRIBUTE	PRODUCT
SACT32E	13"	Curved	CT32E E-SERIES Saw
SBCT32E1	13"	Curved	CT32CE Replacement Blade
SACT42PRO	16.5"	Curved	CT42PRO SAW
SBCT42PRO1	16.5"	Curved	CT42PRO Replacement Blade



# handsaws

CUTTING + PRUNING / HANDSAWS

## ARS Professional Series 7" Straight Saw



The **ARS Professional Series 7" straight saw** are world leaders in design and production of pruning saws for professionals. Great for ornamental pruning, especially while working in shrubs like lilac, forsythia, and caned forming plants.

### SPECS + FEATURES

- Length: 7" straight saw blade
- Replacement blades and other spare parts available

SKU	SIZE	ATTRIBUTE	PRODUCT
SACAM18PRO	7"	Straight	CAM18PRO Saw
SB-18PRO1	7"	Straight	CAM18PRO Replacement Blade
SACAM24PRO	10"	Straight	CAM24PRO SAW
SB24PRO1	10"	Straight	CAM24PRO Replacement Blade



## ARS Folding Saw - 7" Curved Blade



Versatile, precise cutting efficiency, specially suited to the demands of vineyard, orchard and horticultural work.

### SPECS + FEATURES

- Rugged, high 7" carbon steel blade has chrome plating, and cuts on the pull stroke.
- Blade is thickened on the backside for added strength, and demanding sawing.
- Rubberized grip.
- Folding saw locks in the open or closed position.
- Unique tooth design for clean, accurate cutting.

SKU	SIZE	ATTRIBUTE	PRODUCT
SAGR17	7"	Curved	GR-17-1 Folding Saw
SB-GR171	7"	Curved	SA-GR17 Replacement Blade



## Felco Folding Saw



**Felco's 600** folding pull stroke pruning saw's conical blade and expertly designed teeth geometry eliminate clogging and sap build-up for efficient high performance cutting of large diameters.

### SPECS + FEATURES

- High quality steel, rust resistant chromed blades deliver effortlessly clean, precise cuts, while impulse heated blade teeth resist corrosion for maintenance free long term satisfaction.
- Ergonomic non-slip handle increases comfort and safety while working.
- Folds and can be easily carried in pocket.
- Cutting Capacity: 5 cm | 1.97"

SKU	SIZE	ATTRIBUTE	PRODUCT
F600	6.3"	Folding	Felco Folding Saw F600



## Felco Handsaw



The **Felco 621** pruning saw is the ideal companion to your hand pruners. The lightweight saw cuts easily on the pull stroke. This compact saw enables you to get into tight spaces while ornamental pruning. Branch too big to cut with your hand snips, no problem.

### SPECS + FEATURES

- Comfortable non-slip handle
- Detachable belt loop
- Included scabbard left or right handed use

SKU	SIZE	ATTRIBUTE	PRODUCT
11621		Straight	Handsaw F621





## Corona RazorTooth Handsaw 13"



### SPECS + FEATURES

- Impulse-hardened teeth for long service life
- Replaceable 13" blade
- For medium to large branches
- 3-Sided razor teeth for efficient cutting
- Cushioned, co-molded pistol grip
- Convenient hanging hole

SKU	SIZE	ATTRIBUTE	PRODUCT
000357	13"	Curved	RazorTooth Handsaw 13"
7100-1	13"	Curved	RazorTooth Blade 13"



## Corona QuickSaw AC9100 13" Pruning Saw



### SPECS + FEATURES

- Made with the same SK4 high-carbon steel used in expensive precision cutting tools, QuickSaw's exclusive patent-pending tooth pattern delivers a 20% faster cut than comparable professional saws.
- High-carbon, impulse-hardened teeth stay sharp longer meaning fewer replacement blades!
- Dependable stroke and hooked blade keep the saw moving smoothly for a safer, more stable cut.
- Elastomer grip handle reduces hand fatigue by dampening vibrations and provides superior grip when wet or dry.
- Cutting Length: 13"; Overall Length: 19-3/4"

SKU	SIZE	ATTRIBUTE	PRODUCT
006935	13"	Curved	QuickSaw 13" Pruning Saw
AC7990	13"	Curved	Quick Saw Pruner Blade AC9100



## Corona AC7241 RazorTooth Saw Tree Pruner Blade



### Corona AC 7241 RazorTooth Saw Tree Pruner Replacement Blade

### SPECS + FEATURES

- Steel Alloy Blade
- Length: 13"
- Fits models: TP 6870 | TP 6850 | TP 6830 | TP 6780"

SKU	SIZE	ATTRIBUTE	PRODUCT
AC7241	13"	Curved	AC7241 RazorTooth Saw Blade



# handsaws

CUTTING + PRUNING / HANDSAWS

## Fanno Handsaw – Curved Tri-cut Saw



Great hardwood handled pruning saw.

### SPECS + FEATURES

- 13" cutting edge with Tri-Edge teeth
- Contoured laminated hardwood handle
- Teeth per inch: 6

SKU	SIZE	ATTRIBUTE	PRODUCT
FI1311	13"	Curved	Handsaw 1311 – Curved Tri-cut Saw
FI13S-B	13"	Curved	Blade 1311



## Fanno Saw FI-1700



### SPECS + FEATURES

- 15" cutting edge 5.5 points per inch with Tri-Edge teeth
- Special formula extra heavy gauge saw steel
- Contoured laminated hardwood handle
- Teeth per inch: 6

SKU	SIZE	ATTRIBUTE	PRODUCT
FI1700C	15"	Curved	Saw FI-1700
FI17S-B	16"	Curved	Blade 1700



## Fanno Orchard Curve Saw



Designed for the cutting of hardwoods such as citrus fruit trees and general orchard pruning.

### SPECS + FEATURES

- Smaller tooth, enabling you to cut hardwoods without tearing the bark
- 13" cutting edge – 7 points per inch lance teeth
- 19 gauge special formula saw steel
- Handle: rigid hardwood 8"

SKU	SIZE	ATTRIBUTE	PRODUCT
000346	14"	Curved	Orchard Curve Saw 14



## Fanno Tri-cut Gullet Saw



Fanno Tri-cut Gullet 1500 handsaws are one of the most popular saws with tree care professionals for decades.

### SPECS + FEATURES

- Tri-edge raker blade, which will make quick work of branches and limbs.
- Gullets improve the removal of chips
- Large contoured laminated hardwood handle protects your hand against damage while cutting
- Blades are easily replaced with a screwdriver
- Blades can also be used on a pole saw
- Scabbard sold separately

SKU	SIZE	ATTRIBUTE	PRODUCT
FI-K1500	14"	Curved/Raker	Tri-cut K1500 Saw
FI-K15SB	14"	Curved/Raker	Blade 15S 1500





# hand pruners

## Felco Hand Pruner 160S



### SPECS + FEATURES

- Incredibly light, reliable, hard-wearing and comfortable handles
- Made for small hands.
- Ergonomic: hand and wrist protection are provided by the ideal shape of the handles / pleasant feel
- Blade and anvil blade made of high-quality hardened steel
- Clean and precise cut
- All parts suffering wear and tear are replaceable
- Cutting capacity: 20 mm
- Length: 200 mm
- Weight: 175 g

SKU	SIZE	ATTRIBUTE	PRODUCT
160S			Hand Pruner 160S



## Felco Hand Pruner F2



The most recommended bypass pruners in the world. Many an arborist or master gardener would not leave the house without their trusty F2 pruner.

### SPECS + FEATURES

- Strong, solid-forged aluminum-alloy handles have easy-to-grip covers and are nearly unbreakable.
- Swiss precision-made, hardened, replaceable cutting blade.
- Anvil blade with a sap groove never needs sharpening and should last a lifetime.
- Rubber cushion and shock absorber provide smooth working and soft closing to spare your hands and wrists.
- Cutting capacity: 1"
- Length: 8 1/2 inches
- Weight: 8.5 ounces

SKU	SIZE	ATTRIBUTE	PRODUCT
112			Hand Pruner F2



## Felco F5 Hand Pruner



Reliable, efficient, and ergonomically designed – this pruner provides clean, precise cuts and overall good performance in a more basic model.

### SPECS + FEATURES

- Sturdy steel handles with a non-slip handle coating
- Hardened steel blades
- Easy cutting adjustment
- All parts can be replaced
- Hand Size: Large
- Cutting Size: 25 mm | 1"
- Length: 225 mm | 8.9"
- Weight: 310 g | 10.9 oz

SKU	SIZE	ATTRIBUTE	PRODUCT
F5			F5 Hand Pruner



## Felco F6 Hand Pruners



### SPECS + FEATURES

- Reliable: Comfortable, light, sturdy handles made of forged aluminum with a lifetime guarantee / blade and screw-mounted anvil blade made of high-quality hardened steel / clean, precise cut / all parts can be replaced.
- Efficient: Easy, durable cutting adjustment / wire cutting notch / sap groove.
- Ergonomic: Hand and wrist protection are provided by the ideal shape of the handles and the cushion-shock absorber / non-slip coating.
- Hand size: Medium
- Cut diameter: 20 mm
- Length: 195 cm
- Weight: 210 g

SKU	SIZE	ATTRIBUTE	PRODUCT
F6			F6 Hand Pruner



# hand pruners

CUTTING + PRUNING / HAND PRUNERS

## Felco F7 Revolving Handle Pruner



The **FELCO 7** is a powerful and ergonomically-designed tool that is particularly suitable for anyone with larger hands and is at its very best when tackling heavy-duty, intensive pruning tasks.

### SPECS + FEATURES

- Tool with revolving handle for right-handed pruning.
- Bypass pruning shears / secateurs
- Handles in forged aluminum with lifetime guarantee (All parts can be replaced)
- Blade/counter blade constructed of hardened steel with sap groove and wire cutting notch
- Blade with locking segment nut for easy adjustment of cutting head
- Tool adjustment key included for cutting head and closing lock adjustment
- Phthalate-free non-slip handle coating
- Hand size: Large

SKU	SIZE	ATTRIBUTE	PRODUCT
F7			F7 Hand Pruner



## Felco Hand Pruner F8



### SPECS + FEATURES

- **Reliable:** Comfortable, light, sturdy handles made of forged aluminum with a lifetime guarantee / blade and screw-mounted anvil blade made of high-quality hardened steel / clean, precise cut / all parts can be replaced.
- **Efficient:** Easy, durable cutting adjustment / wire cutting notch / sap groove.
- **Ergonomic:** Hand and wrist protection and optimization of the force exerted are provided by the ideal shape of the handles, the angled head and the cushion-shock absorber / non-slip coating.
- Hand size: Large
- Cut Diameter: 25 mm
- Length: 210 mm
- Weight: 245 g

SKU	SIZE	ATTRIBUTE	PRODUCT
F8			F8 Hand Pruner



## Felco F9 Hand Pruner – For Lefties!



The **Felco F9** is a high performance model for left-handed users specially designed for increased comfort and efficiency.

### SPECS + FEATURES

- Lightweight handles made of forged aluminum with nonslip coating and lifetime guarantee (All parts can be replaced)
- Hardened steel blade and screw-mounted anvil blade
- Wire cutting notch and Sap groove
- Micro-metric adjustment system for optimal cutting head adjustment
- Ergonomically designed angled cutting head, handle shape, and cushioned shock absorption system reduce risk of injury and enhance comfort and efficiency
- Hand Size: Large
- Cutting Capacity: 25 mm | 1"
- Length: 210 mm | 8.3"
- Weight: 245 g | 8.6 oz

SKU	SIZE	ATTRIBUTE	PRODUCT
119			F9 Hand Pruner – For Lefties!



## Felco F10 Revolving Handle Pruner – For Lefties!



### SPECS + FEATURES

- High performance model for left-handed users
- Ergonomic design prevents tendinitis (RSI) and carpal tunnel syndrome, reducing physical effort and increasing comfort and ease of use.
- Lightweight, forged aluminum handles with nonslip coating and lifetime guarantee, hardened steel blade and screw-mounted anvil blade, wire cutting notch for damage free cutting of small wires, sap groove for clean, easy cutting of sticky wood, and micro-metric adjustment system for optimal cutting head adjustment.
- Revolving handle reduces overall cutting effort by 30 percent by distributing effort across all fingers.
- Hand size: Large
- Cutting Capacity: 25 mm | 1"
- Length: 210 mm | 8.3"
- Weight: 290 g | 10.2 oz

SKU	SIZE	ATTRIBUTE	PRODUCT
1110			Felco Hand Pruner F10





## Felco F-13 Pruner Use With one Or Two Hands



### SPECS + FEATURES

- Ergonomic design prevents tendinitis (RSI) and reduces physical effort, enhancing comfort and ease of use.
- Lightweight forged aluminum handles with nonslip coating and lifetime guarantee, hardened steel blade and screw-mounted anvil blade, wire cutting notch for damage free cutting of small wires, sap groove for clean, easy cutting of sticky wood, and micro-metric adjustment system for optimal adjustment.
- Ergonomically designed angled cutting head, handle shape, and cushioned shock absorption system support muscles and joints for comfort and ease of use.
- The Felco 13's lever arm handle design allows use with one or two hands for up to 25% reduced effort.
- Hand Size: Large
- Cutting Capacity 30 mm/1.2 in
- Length 270 mm/10.6 in
- Weight 310 g/10.9 oz

SKU	SIZE	ATTRIBUTE	PRODUCT
1113			Felco Hand Pruner F13



## Felco Pruner Replacement Blades



Top quality **Felco** replacement cutting blades to keep your pruners in "like new" condition. Precision-made Swiss cutting blades made of hardened steel for durability. If your blade is chipped or cracked, or your pruners no longer close all the way to the tip; then its time for a new blade.

SKU	SIZE	ATTRIBUTE	PRODUCT
43619	F6/12		Pruner Replacement Blades
1223	F2,4,11		Pruner Replacement Blades
93	F9,10		Pruner Replacement Blades
73	F7,8		Pruner Replacement Blades
43588	F5		Pruner Replacement Blades
6003	F600		Pruner Replacement Blades
621/3	F620		Pruner Replacement Blades
12133	F13-3		Pruner Replacement Blades
6103	F61,610		Pruner Replacement Blades

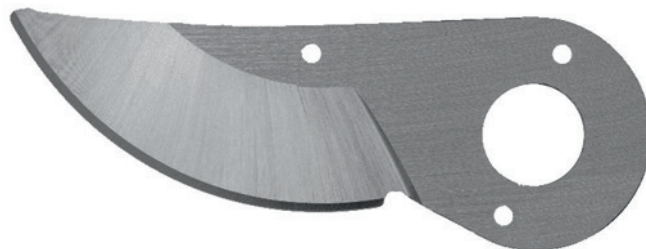

## ARS DX Series Hand Pruner - HP-120DX



Hard chrome plated, wipe clean blades and comfortable grip.

### SPECS + FEATURES

- Lightweight
- Japanese style v-spring
- Stay sharp blades
- Capacity: 22 mm | <1"
- Weight: 6.3 oz

SKU	SIZE	ATTRIBUTE	PRODUCT
HP120DX	8"		HP-120DX Hand Pruner



## Corona Bypass Hand Pruner - Model BP6250



### SPECS + FEATURES

- Forged with light metal alloy but lighter and smaller than the others
- Cuts capacity 1" diameter
- Weight: 7.5 oz

SKU	SIZE	PRODUCT
BP6250	8-1/2"	Corona Hand Pruner BP6250
6250-1T		Bypass Hand Pruner Replacement Blade



# hand pruners

CUTTING + PRUNING / HAND PRUNERS

## Fred Marvin Leyat Multi-Purpose Hand Shears



**Leyat** multipurpose hand shears for gardening with reinforced cutting head. Designed use: Horticulture, Arboriculture, & Vineyards

### SPECS + FEATURES

- High-performance, general purpose shear for medium to large sized hands
- Ergonomic handles with integrated shock absorber for hand and wrist protection
- Constructed from forged aluminum to be lightweight, strong and sturdy
- Alloy steel cutting head
- PTFE coating keeps shears rust-free and sap-free
- 1" cutting capacity, 8.5 oz weight

SKU	SIZE	ATTRIBUTE	PRODUCT
NL2	8.5"		Leyat Multi-Purpose Hand Shears



## Fred Marvin Super Pro Hand Shears



### SPECS + FEATURES

- Professional pruning shears with thin cutting head
- Ergonomic handles and integrated shock absorber for long term comfort
- Alloy steel cutting head; forged aluminum body
- PTFE coating keeps shears rust-free and sap-free
- Sap groove and wire cutting notch
- Three opening positions
- Hand size: Medium-Large
- 1.2" cutting capacity, 9.1 oz weight

SKU	SIZE	ATTRIBUTE	PRODUCT
SUPERPRO	8.7"		Super Pro Hand Shears



## Spyder Phoenix 3/4" Hand Pruners

Professional hand pruner forged from high carbon tempered Japanese steel.

### SPECS + FEATURES

- Professional grade quality
- Blade and hook forged from High Carbon
- Ergonomic round lightweight steel handles
- Replacement V-Spring available
- High visibility color combination: red and white
- Cutting capacity: 3/4"

SKU	SIZE	ATTRIBUTE	PRODUCT
40012			Phoenix Hand Pruners
40022	Dealer	24	Phoenix Bucket-O-Pruners





# other cutting tools

## Corona Aluminum Lopper



### SPECS + FEATURES

- Unmatched blade design dramatically reduces force to cut
- Lightweight, high-strength elliptical 26 Inches aluminum handles
- Resharpenable, replaceable, Dual Arc bypass blade of fully heat-treated forged steel
- Forged, slant-ground hook with self-cleaning, deep sap groove
- Capacity: 2 1/4 inches
- Length: 26"

SKU	SIZE	ATTRIBUTE	PRODUCT
AL8442	26"		Aluminum Lopper



## Fred Marvin Long Handle Loppers



For those basal pruning jobs when your plants aren't as friendly as you. Keep away from the plant, but be deliberate about your cuts. What loppers do best: cut while you're far away.

### SPECS + FEATURES

- High quality aluminum, won't rust
- Rubber handles for ergonomic cutting
- Non-round handles for more handle strength
- ML24 – 24" aluminum lopper with a 1-3/4" cutting capacity
- ML28 – 28" aluminum lopper with a 1-3/4" cutting capacity
- ML32 – 32" aluminum lopper with a 2-1/2" cutting capacity
- Replacement parts are available

SKU	SIZE	ATTRIBUTE	PRODUCT
ML24	24"		Long Handle Loppers
ML28	28"		Long Handle Loppers
ML32	32"		Long Handle Loppers



# other cutting tools

CUTTING + PRUNING / OTHER CUTTING TOOLS

## Spyder Hansa Machete 24"

Spyder  
MANUFACTURING / USA

### SPECS + FEATURES

- Classic machete with easy to find red plastic handle
- Blade length: 24"

SKU	SIZE	ATTRIBUTE	PRODUCT
47103			Hansa Machete 24"



## Spyder Heavy Duty Machete 18"

Spyder  
MANUFACTURING / USA

### SPECS + FEATURES

- Heavy Duty Machete with long wood handle.
- Blade length: 18"

SKU	SIZE	ATTRIBUTE	PRODUCT
47120	18"		Heavy Duty Machete 18"



## Silky YOKI Chopper

Silky  
World's finest saw

Meet the ultimate tool to chop multiple vegetation types. For people who work and play outdoors the YOKI is versatile enough to attack pesky poisonous or invasive vines, or to cut limbs and small logs to a more manageable size.

### SPECS + FEATURES

- Durable and long lasting, resharpenable blade
- Length: 10.6" | 270 mm
- Metal: Alloy Steel
- Blade Thickness: 2.75 mm
- Scabbard: included

Silky products not available for distribution in the Florida market.



SKU	SIZE	ATTRIBUTE	PRODUCT
570-27	10.6"		YOKI Chopper
571-27			YOKI Chopper Replacement Blade



# 7 | Rigging



BLOCKS.....	220
SLINGS.....	223
RIGGING RINGS.....	227
CHAINS.....	228
PULLEYS.....	229
CARABINERS.....	232
RIGGING DEVICES.....	235

# blocks

## ISC Compact Rigging Pulley for 13 mm (1/2") Rope

### SPECS + FEATURES

- Easy one hand operation: spring-lock open/closure mechanism
- Pulley Plates: Hot forged Aluminum
- Max Rope Capacity: 13 mm / 1/2" (38 kN / 8,500 lbs)
- Topping Strap: 16 mm | 5/8" (74 kN | 16,650 lbs)
- MBS: 85 kN | 19,000 lbs
- WLL: 17 kN | 3,800 lbs
- Weight: 490 g | 1 lb
- Approved standards CE 012



I|S|C  
SOLUTIONS IN METAL

SKU	PRODUCT
RP048A1	Compact Rigging Block 1/2 RP048A1

## ISC Small Cast Pulley for 13 mm (1/2") Rope

### SPECS + FEATURES

- Easy one hand operation: spring-lock open/closure mechanism
- Max Rope Capacity: 13 mm / 1/2" (45 kN / 9,900 lbs)
- Topping Strap: 19 mm / 3/4" (106 kN | 23,400 lbs)
- MBS: 100 kN | 22,000 lbs
- WLL: 20 kN | 4,400 lbs
- Weight: 1490 g | 3.28 lbs
- Approved standards CE 012



I|S|C  
SOLUTIONS IN METAL

SKU	PRODUCT
RP050A1	Rigging Block 1/2 RP050A1

## ISC Flame Rigging Arborist Block for 16 mm (5/8") Rope

### SPECS + FEATURES

- Heavy-duty screw lock rigging block
- Cool, unique design... flame pattern helps to reduce overall weight of block
- Max Rope Diameter: 16 mm / 5/8"
- Materials: Stainless Steel/Aluminum
- MBS: 22,480 lbs / 100 kN
- WLL: 4,400 lbs / 2,000 kg
- Weight: 3.5 lbs / 1.6 kg
- Certs: CE approved, individually serial numbered



I|S|C  
SOLUTIONS IN METAL

SKU	PRODUCT
RP056A FLAME	Rigging Block 5/8 Flame RP056A

## ISC Cast Rigging Pulley for 16 mm (5/8") Rope

### SPECS + FEATURES

- Easy to handle and open push pin design; Sheave won't drop when opened
  - Material: Aluminum
  - MBS: 100 kN / 22000 lbs
  - WLL: 20 kN / 4400 lbs
  - Max Working Line Size (MBS)\* 5/8" / 16 mm (77 kN / 17000 lbs)
  - Topping Strop Size (MBS)\*: 1" / 25 mm (172 kN / 37800 lbs)
- \*Above figures based on using Yale Polydyne or Double Esterlon 5/8 rope.



I|S|C  
SOLUTIONS IN METAL

SKU	SIZE	ATTRIBUTE	PRODUCT
RP051A1 RED			Rigging Block 5/8 RP051A1





## ISC Cast Pulley for 19 mm (3/4") Rope

### SPECS + FEATURES

- Easy one hand operation: Push pin release
- Material: Aluminum
- Max Working Rope capacity: 19 mm / 3/4" (106 kN / 23,400 lbs)
- Topping Strap Size: 29 mm / 1 1/8" (213 kN / 46,800 lbs)
- MBS: 150 kN / 33,000 lbs
- WLL: 30 kN / 6,600 lbs
- Weight: 4.9 lbs / 2.2 kg

SKU	SIZE	ATTRIBUTE	PRODUCT
RP055A1			Rigging Block 3/4 RP055A1



## Rock Exotica Omni-Block Swivel Pulleys Single Sheave

Rock Exotica's Omni-Block combines a swivel and pulley into one tool shortening the length of your rigging. Incorporates a unique sideplate that opens while the pulley is still attached allowing you to change rope without detaching from anchor.



### SPECS + FEATURES

- Allows up to 0.5" (13 mm) rope
- Integrated swivel top allows the pulley to orient as needed in response to load
- Pulley body is machined from a solid block of aluminum for strength
- Certification: CE
- 1.1" Single sheave - Weight 5.1 oz (145 gm); MBS 23 kN; WLL 5 kN
- 1.5" Single sheave - Weight 9.2 oz (260 gm); MBS 36 kN; WLL 8 kN
- 2.0" Single sheave - Weight 12.3 oz (348 gm); MBS 36 kN; WLL 8 kN
- 2.6" Single sheave - Weight 1.9 lbs (850 gm); MBS 80 kN; WLL 20 kN

SKU	SIZE	COLOR	PRODUCT
P54	1.1	Gold	Omni Block Single Pulley 1.1 P54
P51B BLACK	1.5	Black	Omni Block Single Pulley 1.5 P51B
P51 GOLD	1.5	Gold	Omni Block Single Pulley 1.5 P51
005108	2.0	Gold	Omni Block Single Pulley 2.0 P53
P55	2.6	Gold	Omni Block Single Pulley 2.6 P55

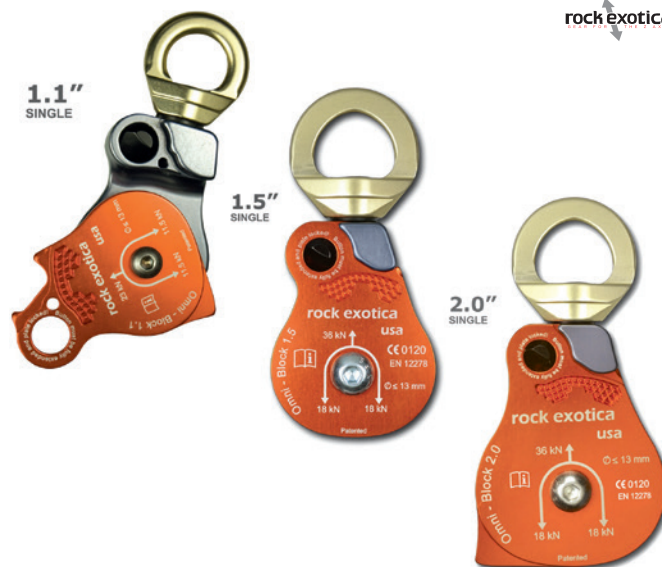

## CMI Stainless Steel Block Pulleys

CMI stainless steel blocks are engineered to take on the most demanding rigging jobs, the block cheeks are made from high strength stainless steel to give you years of service.



### SPECS + FEATURES

- Aluminum alloy bushings and sheaves are supported by stainless steel axles
- Upper bushing easily accessed by a no-slip knob, and it is captive
- Cheek plates are broad enough to protect lines during use
- RP130 - MBS: 28,000 lbs (12,725 kg); WLL: 5,600 lbs (5:1 ratio); Max Rope: 5/8" (16 mm); Sheave: 3" (76 mm); Weight: 2.3 lbs (2.1 kg)
- RP131 - MBS: 40,000 lbs (18,000 kg); WLL: 4,000 (10:1 ratio); Max Rope: 3/4" (20 mm); Sheave: 4" (100 mm); Weight: 5.6 lbs (2.5 kg)

SKU	SIZE	ATTRIBUTE	PRODUCT
RP130	5/8"		RP130 Stainless Block 5/8
RP131	3/4"		RP131 Stainless Block 3/4



## CMI RP146 Arborist Block

RP146 is a giant arborist rigging block designed for your beefiest ropes.

### SPECS + FEATURES

- Aluminum side plates and sheave; Stainless Steel axle
- Bushing
- MBS: 68,000 lbf. (302.4 kN)
- Safe Working Load: 13,600 lbs.
- Weight: 6.9 lbs.
- Size: 9.25" x 6"
- Rope Capacity: Up to 1"

SKU	SIZE	ATTRIBUTE	PRODUCT
RP146	1"		Arborist Block RP146



DESIGNED FOR  
1" LINES—A  
TRUE WORKHORSE



## DMM Impact Block - Small 16 mm or Large 20 mm

### SPECS + FEATURES

- Rounded edges to cheek-plates maintain low rope abrasion
- Fairlead flares help maintain high working efficiency
- Thrust surfaces increase tolerance to external loading of spindle and anchor pin
- Lightweight attachment sling facilitates hauling of block, sling, and rope to the climber and helps with handling, in tree stowage and workshop storage
- Direct connection, anchor slings ensure correct neighbor component compatibility
- High efficiency oilite bushings to reduce friction
- Conforms to EN12278:2007; Conforms to NFPA 1983(2012 ED) Class G; Coloring follows EU WLL protocol
- Small: Max Rope 16 mm | 5/8"; MBS 200 kN; WLL 40 kN; Weight 1.86 kg
- Large: Max Rope 20 mm | 3/4"; MBS 300 kN; WLL 60 kN; Weight 3.47 kg

SKU	SIZE	ATTRIBUTE	PRODUCT
IMB-S	16 mm	Titanium/Green	Impact Block Small
IMB-L	20 mm	Bronze/Lime	Impact Block Large



CENTER HOLE DESIGNED FOR  
ADDITIONAL RIGGING LINE; OH THE  
ADVANTAGES OF HAVING OPTIONS.

## DMM XS Bat Plate

DMM Bat Plates raise the bar in design, performance and strength. Precision machining and heat treatment make them strong, light and incredibly versatile.

### SPECS + FEATURES

- Textile friendly surfaces with large radii
- Centralized connection point for stable rescuer attachment
- CNC machined from high strength heat treated aluminum
- Anodized to BS EN 7599:2010 AA10; Sealed for corrosion protection
- Conforms to NFPA 1983 (2012 Ed) Class G
- MBS 36 kN; WLL 7 kN; Weight 37 g

SKU	SIZE	ATTRIBUTE	PRODUCT
RIG-XS-OR	XS	Orange	Bat Rigging Plate XS



DON'T LET ITS  
SIZE FOOL YOU.

## DMM Rigging Hub

DMM's Rigging Hubs have four kidney shaped slots, a super strong central eye and four hang points that give numerous options for complex rigging.

### SPECS + FEATURES

- Small - Breaking strength of 45 kN (outer kidney slots) and 80 kN (central eye)
- Large - Breaking strength of 45 kN (outer kidney slots) and 150 kN (central eye)
- Textile friendly connection points for rope, webbing and opposed connectors
- Central hole can accommodate a running rope and facilitates 3D rigging
- CNC machined from top grade alloy for strength, durability and lightness
- Anodized to BS EN 7599:2010 AA10 Sealed for corrosion protection
- Individually marked for traceability

SKU	SIZE	ATTRIBUTE	PRODUCT
ARB-HUB108	Small		Small Rigging Hub
ARB-HUB175	Large		Large Rigging Hub



GREAT TO CREATE A  
FLOATING HUB—CONNECTING  
SEVERAL LINES TO ONE  
CENTRAL LOCATION



# slings



## US Rigging False Crotch Block Sling

Aluminum block with composite double braid bull rope and dead eye sling featuring a nylon core and polyester cover.

### SPECS + FEATURES

- Rigging block accommodates rope up to 1" in diameter
- Dead eye sling rope diameter is 3/4" with a 25,700 lb tensile strength.
- Rope features nylon core and polyester cover
- Urethane coated for abrasion resistance
- 6" eye on one end



SKU	PRODUCT
FCBS16	False Crotch Block Sling

## Double Braid Dead-Eye Rigging Sling 1/2"

### SPECS + FEATURES

- Eye size: 12"+
- Construction: Double Braid Rigging Sling
- Diameter: 1/2"
- MBS: 8,800 lbs

A CUSTOMER FAVORITE FOR OVER 25 YEARS!



CUSTOMIZED PRODUCT

SKU	SIZE	PRODUCT
006489	10'	Rigging Sling Double Braid 1/2
005466	12'	Rigging Sling Double Braid 1/2

## Double Braid Dead-Eye Rigging Sling 5/8"

### SPECS + FEATURES

- Eye size: 12"+
- Construction: Double Braid Rigging Sling
- Diameter: 5/8"
- MBS: 13,900 lbs



CUSTOMIZED PRODUCT

SKU	SIZE	PRODUCT
001859	10'	Double Braid Rigging Sling 5/8
001858	12'	Double Braid Rigging Sling 5/8

## Double Braid Dead-Eye Rigging Sling 3/4"

### SPECS + FEATURES

- Eye size: 12"+
- Construction: Double Braid Rigging Sling
- Diameter: 3/4"
- MBS: 17,300 lbs



CUSTOMIZED PRODUCT

SKU	SIZE	PRODUCT
012066	14'	Double Braid Rigging Sling 3/4
000393	18'	Double Braid Rigging Sling 3/4

## Samson Tenex-TEC Dead-Eye Sling 1/2"

CUSTOMIZED PRODUCT

### SPECS + FEATURES

- Eye size: 12"+
- Construction: 12 Strand Hollow Braid
- Diameter: 1/2"
- MBS: 11,800 lbs

SKU	SIZE	PRODUCT
004015	8'	Samson Tenex Sling 1/2
001378	12'	Samson Tenex Sling 1/2



## Samson Tenex-TEC Dead-Eye Sling 5/8"

CUSTOMIZED PRODUCT

Tried, true and strong. Our **Samson Tenex-TEC dead-eye sling** for attaching rigging blocks and tools to stems and branches of trees. Lightweight, steady fast colors and soft hand. **Tenex-TEC** is a high-strength, low-stretch rope designed with two ends per carrier. The construction of this line allows for more rope surface to stay in contact with the tree and or branches.

### SPECS + FEATURES

- Eye Size: 5"
- Construction: 12 Strand Hollow Braid
- Diameter: 5/8"
- MBS: 16,900 lbs

SKU	SIZE	PRODUCT
002070	12'	Samson Tenex Sling 5/8
002736	16'	Samson Tenex Sling 5/8



## Samson Tenex-TEC Dead-Eye Sling 3/4"

CUSTOMIZED PRODUCT

Great for rigging blocks, pulleys, and porta-wraps. Hand spliced.

### SPECS + FEATURES

- Eye size: 12"
- Construction: 12 Strand Hollow Braid
- Diameter: 3/4"
- MBS: 20,200 lbs

SKU	SIZE	PRODUCT
006579	14'	Samson Tenex Sling 3/4
001377	18'	Samson Tenex Sling 3/4



## Samson Tenex-TEC Whoopie Sling

CUSTOMIZED PRODUCT

Great sling for quick attachment of rigging blocks or port-a-wraps. Easily adjusted.

### SPECS + FEATURES

- Eye size: 12"+
- Construction: Hollow Braid; Adjustable
- Diameter: 1/2", 5/8", 3/4"
- MBS: 1/2": 11,800 lbs, 5/8": 16,900 lbs, 3/4": 20,200 lbs

SKU	SIZE	ATTRIBUTE	PRODUCT
000394	2-5'	Adj	Sling 1/2"
000396	4-7'	Adj	Sling 5/8"
000395	6-10'	Adj	Sling 3/4"







## Samson Whoopie Adjustable Slings

### SPECS + FEATURES

- Double-braid/composite construction of polyester cover over nylon core
- Adjustable, load-rated two-eye lifting slings – A permanent eye splice at one end and an adjustable eye at the other
- WS0328 – 1/2", 2.5' - 4' L, 5" eye, 2,200 cap (single leg) tagged with capacity
- WS0404 – 5/8", 3' - 5' L, 6" eye, 3,200 cap (single leg) tagged with capacity
- WS0486 – 3/4", 3.5' - 6' L, 7" eye, 4,200 cap (single leg) tagged with capacity
- WS1062 – 3/4", 3.5' - 10' L, 7" eye, 4,200 cap (single leg) tagged with capacity
- WS1462 – 3/4", 3.5' - 14' L, 7" eye, 4,200 cap (single leg) tagged with capacity

SKU	SIZE	ATTRIBUTE	PRODUCT
WS0328	2.5'-4'	Adj	Whoopie Adjustable Slings 1/2
WS0404	3'-5'	Adj	Whoopie Adjustable Slings 5/8
WS0486	3.5'-6'	Adj	Whoopie Adjustable Slings 3/4
WS1062	3.5'-10'	Adj	Whoopie Adjustable Slings 3/4
WS1462	3.5'-14'	Adj	Whoopie Adjustable Slings 3/4



## Samson Tenex Sling Balancer

Control long rig loads with these simple and affordable balancers. Simply hitch to your load line and log end to be balanced with appropriate knots and off you go leveling your load evenly for the ground.

### SPECS + FEATURES

- 3/8" Tensile strength: 6200 lbs
- 1/2" Tensile strength: 10,000lbs

SKU	SIZE	ATTRIBUTE	PRODUCT
004694	12'	Small	Tenex Sling Balancer 3/8"
008864	14'	Large	Tenex Sling Balancer 1/2"



## Weaver Webbing Loop Runners

Constructed of tubular nylon webbing and serve as medium-duty choker straps.

### SPECS + FEATURES

- These lightweight loop runners are as strong and durable as rope.
- Circular construction distributes wear more evenly because you'll seldom clip into the same spot twice.
- Use for speed line chokers, line redirections, miniature false crotch support systems, a limb handle or providing a footstep where none exists.
- MBS: 6500 lbs; Ultimate Breaking Strength: 7100 lbs

SKU	SIZE	ATTRIBUTE	PRODUCT
0898230PU	12"	Purple	Web Loop Runners
0898231BL	24"	Blue	Web Loop Runners
0898232OY	30"	Yellow	Web Loop Runners
0898233BO	36"	Orange	Web Loop Runners
0898234RD	48"	Red	Web Loop Runners



## Weaver Light-Duty Nylon Slings

These nylon webbing slings are perfect for a variety of light-duty lifting tasks.

### SPECS + FEATURES

- Durable, pliable 1" nylon webbing with 3-1/2" loops at each end
- Built with a 5:1 safety factor
- 1,200 lb rating for vertical lifting, 2,400 lb rating for basket lifting, and 960 lb rating for choke hold

SKU	SIZE	ATTRIBUTE	PRODUCT
089823530	30"		Weaver Nylon Sling 30
089823540	40"		Weaver Nylon Sling 40
089823562	62"		Weaver Nylon Sling 62



## CMI Web Loop Runner

### SPECS + FEATURES

- CMI strong 1" tubular webbing runners are known for their bar-tacks.
- Great quality, great price
- Continuous 1" webbing loop
- Strength: 6000lbs

SKU	ATTRIBUTE	PRODUCT
AAS60ORANGE	60"	Web Loop Runner



AVAILABLE IN  
ADDITIONAL  
COLORS

**CMI**

## CMI Heavy Duty Loop Runner

Numbers speak for themselves: these are, quite simply, the strongest runners available today.

### SPECS + FEATURES

- A heavy duty twist to our ever popular regular sewn runners.
- Continuous loops of 1" heavy duty webbing.
- MBS: 14,000 lbs

SKU	ATTRIBUTE	PRODUCT
AAS48HD	48"	Heavy Duty Web Loop Runner
AAS60HD	60"	Heavy Duty Web Loop Runner



**CMI**

## I&I Crane Sling Poly Round Chokers

### SPECS + FEATURES

- Endless loops of polyester load-bearing yarn with a polyester cover
- Design Factor: 5:1
- Configuration: Roundsling or eye-and-eye
- Applications: Vertical, Basket, Choker
- Color coded and labeled for easy identification
- Available with Check-Fast® Inspection System
- MBS: 3': 2400 lbs; 5': 7200 lbs; 8': 9600 lbs; 10': 13600 lbs; 12': 17600 lbs

SKU	SIZE	ATTRIBUTE	PRODUCT
SP300-03	3'	Purple	Choker 2400 lbs
SP900-05	5'	Yellow	Choker 7200 lbs
SP1200-08	8'	Gray	Choker 9600 lbs
SP1700-10	10'	Brown	Choker 13600 lbs
SP2200-12	12'	Blue	Choker 17600 lbs



**I&I**  
SLINGMAX

ADDITIONAL SIZES AVAILABLE

## Pelican Dead Eye Slings

### SPECS + FEATURES

- Double braid/composite construction of polyester cover over nylon core for higher tensile strength and better shock load performance
- Urethane coated for abrasion resistance
- 6" eye on one end w/ heavy duty chafe guard
- ADE20C5-10E – 5/8" dia., 15,300 tensile strength, 10' L
- ADE20C5-15E – 5/8" dia., 15,300 tensile strength, 15' L
- ADE24C5-15E – 3/4" dia., 25,700 tensile strength, 15' L
- ADE24C5-18E – 3/4" dia., 25,700 tensile strength, 18' L
- ADE-32C-20E – 1" dia., 45,000 tensile strength, 20' L

SKU	SIZE	ATTRIBUTE	PRODUCT
ADE20C5-10E	5/8"	10'	Dead Eye Sling 5/8" X 10'
ADE20C5-15E	5/8"	15'	Dead Eye Sling 5/8" X 15'
ADE20C5-18E	5/8"	18'	Dead Eye Sling 5/8" X 18'
ADE24C5-15E	3/4"	15'	Dead Eye Sling 3/4" X 15'
ADE24CY-18E	3/4"	18'	Dead Eye Sling 3/4" X 18'



**PELICAN ROPE**  
The Most Trusted Name In Rope



# rigging rings

## Tylaska Rigging Rings **EXCLUSIVE PRODUCT**

Tylaska

These rings are lighter and smaller than a conventional pulley block. In addition to being lighter and less expensive than conventional blocks, ring ferrules are also less prone to failure since there are no pulleys to crack or bearings to foul. Made in the US.

### SPECS + FEATURES

- Rope Compatibility: Up to 7/8" hollow braid
- TY2714 Size: 20 mm x 14 mm; MBS: 75 kN
- TY2720 Size: 28 mm x 20 mm; MBS: 100 kN
- TY2728 Size: 38 mm x 28 mm; MBS: 125 kN

SKU	SIZE	ATTRIBUTE	PRODUCT
TY2714	S		Rigging Ring TR14
TY2720	M		Rigging Ring TR20
TY2728	L		Rigging Ring TR28



## All Gear Low Friction Rings

ALLGEAR

All Gear LFR's (AGLFR) Low Friction Rings are made of premium aluminum and aircraft quality coating for a super smooth glide when running rigging line through the middle. Excellent add-on to all dead eye slings, whoopie and ring to ring slings.

### SPECS + FEATURES

- Aircraft Quality Coating helps retain Quality and Glide
- 3/4"; MBS: 7,000 lbs
- 1-1/8"; MBS: 14,000 lbs
- 1-1/2"; MBS: 22,000 lbs
- Colors vary

SKU	SIZE	ATTRIBUTE	PRODUCT
AGLFR34 3/4 S	S	3/4"	Low Friction Rings
AGLFR118 1-1/8 M	M	1-1/8"	Low Friction Rings
AGLFR112 1-1/2 L	L	1-1/2"	Low Friction Rings



## ISC Steel Ring

ISC  
SOLUTIONS IN METAL

### SPECS + FEATURES

- Small Steel Ring Diameter: Internal 27mm (1 1/8"); Outside 51mm (2")
- Large Steel Ring Diameter: Internal 45mm (1 3/4"); Outside 70mm (2 3/4")
- MBS: 70kN (15736 lbf)

SKU	ATTRIBUTE	PRODUCT
RIN0012A	SM	ISC Steel Ring
RIN0013A	LG	ISC Steel Ring



RIN0012A

RIN0013A

## Bourdon Forge Steel Cable Ring

BOURDON  
FORGE COMPANY, INC.

Great for hub and spoke cabling systems, as well as rigging applications. Also used as friction saver rings to allow for large eye passage or two attached lines.

### SPECS + FEATURES

- Hot Forged Alloy Steel, Zinc Plated, Thermal Treated
- Ultimate Load: 150 kN (33,750 lbs.)
- Approximate weight: 10 oz.

SKU	ATTRIBUTE	PRODUCT
20041G	LARGE	Steel Cable Ring



FOR ADDITIONAL RINGS, VISIT PAGE 115

# chains

## tRex Custom Rigging Chain **EXCLUSIVE PRODUCT** CUSTOMIZED PRODUCT

tRex custom rigging chains provide strength and versatility in an environment that demands expediency.

### SPECS + FEATURES

- Hi tensile strength and carefully spliced chains loops spaced throughout the length of the sling provide easy chokes to your picks, false crotches, or basal anchors.
- Another choice in knotless rigging.
- With rope strengths as high as 28.7K MBS tRex rigging chains leave little room for doubt!

SKU	SIZE	ATTRIBUTE	PRODUCT
011746	8'	5/8"	Rigging Chain T-Rex 5/8
011737	10'	5/8"	Rigging Chain T-Rex 5/8
011792	12'	5/8"	Rigging Chain T-Rex 5/8
011747	8'	7/8"	Rigging Chain T-Rex 7/8 L-Ring
011791	12'	7/8"	Rigging Chain T-Rex 7/8 L-Ring



## All-Gear Husky-12 Soft Rig Slings



Used in place of a block and pulley, this sling is much lighter and set to a working position in seconds. With no rig points, this sling adjusts to fit any diameter limb with protective chafe sleeve at the wear points.

### SPECS + FEATURES

- 10 rigging eyes – sliding outer ballistic nylon outer jacket 3' which slides to cover any of the "ten rig point eyes" for extended life.
- Premium Coating provides excellent resistance to chemicals, sunlight, and abrasion.
- AGSRS-12S-128 – Red; Diameter: 1/2" x 8' L; ABS: 11,000 lbs; Weight: 3 lbs
- AGSRS-1210 – Red; Diameter: 1/2" x 10' L; ABS: 11,000 lbs; Weight: 3 lbs
- AGSRS-12S-5810 – Yellow; Diameter: 5/8" x 10' L; ABS: 16,000 lbs; Weight: 4 lbs
- AGSRS-12S-3410 – Green; Diameter: 3/4" x 10' L; ABS: 22,000 lbs; Weight: 5.5 lbs

SKU	SIZE	ATTRIBUTE	PRODUCT
AGSRS-128	8'	Red	Soft Rig Ring Sling 1/2
AGSRS-1210	10'	Red	Soft Rig Ring Sling 1/2
AGSRS-5810	10'	Yellow	Soft Rig Ring Sling 5/8
AGSRS-3410	10'	Green	Soft Rig Ring Sling 3/4

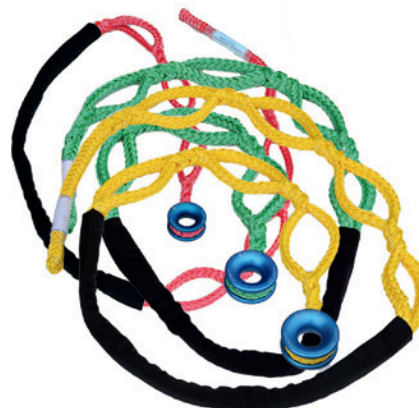

## Sterling BARC



Sterling's BARC or Big Ass Rigging Chain is what the Sterling field testers dubbed it. Actually, BARC stands for Basal Anchor Rigging Chain, but who are we to argue? Try one and you'll be a believer. Building on the popularity of Sterling's versatile Chain Reactors, the BARC is made from 1" T9800 nylon webbing sewn into individual full-strength loops for an adjustable and incredibly strong chain.

### SPECS + FEATURES

- Designed for use as a basal anchor with your Porta-wraps or other friction brake lowering device
- BARC can also accommodate your rigging block aloft. BARC comes in 5ft and 8.5ft versions to accommodate trees up to 19" and 32" in diameter, respectively.
- MBS: 6,182 lb, each individual loop has a strength rating of over 11,000 lb
- Available Length: 5' (8.5' is the Red)
- Standards: ANSI Z133

SKU	ATTRIBUTE	PRODUCT
SW25498RC10	8.5'	BARC – Red
SW25498RC60	5'	BARC – Blue





# pulleys

## CMI Aluminum 5/8" Pulley with Bushing

The **RP102** pulley is a step up in strength and durability. Black Anodized Aluminum sideplates, Stainless Steel axle.

### SPECS + FEATURES

- 2 3/8" Aluminum sheave
- Rope Capacity: 5/8"
- MBS: 6,000 lbs
- Size: 4.25" x 3.25"
- Weight: 0.45 lbs

SKU	SIZE	ATTRIBUTE	PRODUCT
RP102	5/8"		RP102 Pulley 5/8



*CMI*

## CMI Cable Able Pulley

They set the standard for lightweight, compact, and functional pulleys 50 years ago. Stainless steel side plates and axle.

### SPECS + FEATURES

- 2 3/8" Steel sheave, bearing
- Rope Capacity: 5/8"
- MBS: 8,500 lbs
- Size: 4.375" x 3.5"
- Weight: 0.9 lbs

SKU	SIZE	ATTRIBUTE	PRODUCT
RC104	5/8"		RC104 Cable Able Pulley



*CMI*

## CMI Stainless Steel 5/8" Pulley

### SPECS + FEATURES

- Stainless steel sideplates and axle; Aluminum bushing
- 3" aluminum sheave
- Rope Capacity: 5/8"
- MBS: 16,000 lbs
- Size: 6.5" x 4.25"
- Weight: 1.35 lbs

SKU	SIZE	ATTRIBUTE	PRODUCT
RP105	5/8"		RP105 Stainless Pulley 5/8



*CMI*

## CMI 5/8" Double Pulley

This is a double sheave version of the **CMI RP105**. Additional sheave provides an extra 4,000 lbs over the standard.

### SPECS + FEATURES

- Stainless steel side plates and axle
- Two 3" aluminum sheaves.
- Rope Capacity: 5/8"
- MBS: 20,000 lbs
- Size: 7.25" x 4.25"
- Weight: 2.35 lbs

SKU	SIZE	ATTRIBUTE	PRODUCT
RP105D	5/8"		RP105D Stainless Pulley 5/8



*CMI*

## CMI 1/2" Micro Rescue Double Pulley



### SPECS + FEATURES

- Purple Anodized Aluminum sideplates, two 1 1/4" Aluminum sheaves, Bushing, and Aluminum axle.
- Rope Capacity: 1/2"
- MBS: 7,000 lbs
- Dimensions: 3.5" x 1.75"
- Weight: 0.25 lbs

SKU	SIZE	ATTRIBUTE	PRODUCT
RP110D	5/8"		RP110D Double Pulley



REFER TO PAGE 150  
FOR THE RP110



## CMI 5/8" Double Ended Pulley



### SPECS + FEATURES

- Stainless Steel Sideplates and Axle; Two 3/8" Aluminum Sheaves, Bushing
- Rope capacity: 5/8"
- MBS: 8,500 lbs
- Dimensions: 5.75" x 3"
- Weight: 0.7 lbs

SKU	SIZE	ATTRIBUTE	PRODUCT
RP111	5/8"		RP111 Double Ended Pulley



## CMI 1/2" Aluminum Bushing Pulley



### SPECS + FEATURES

- Red anodized Aluminum Sideplates; Stainless Steel axle; 2" Aluminum Sheave; Bushing
- Rope Capacity: 1/2" (13 mm)
- MBS: 7,500 lbs
- Dimensions: 5 x 2.5"
- Weight: 0.45 lb

SKU	SIZE	ATTRIBUTE	PRODUCT
RP115	1/2"	Aluminum	RP115 Pulley



ALUMINUM

## CMI 1/2" Stainless Steel Bushing Pulley



### SPECS + FEATURES

- Stainless Steel Sideplates And Axle; 2" Steel Sheave; Steel Bushing
- Rope Capacity: 1/2" (13 mm)
- MBS: 8,000 lbs
- Dimensions: 5" x 2.5"
- Weight: 0.75 lbs

SKU	SIZE	ATTRIBUTE	PRODUCT
RP118	1/2"	Stainless	RP118 Stainless Pulley 1/2



STAINLESS

## CMI 2" Aluminum NFPA Double Rescue Pulley



### SPECS + FEATURES

- Stainless Steel Sideplates; Two 2" Aluminum Sheaves; Bearing; Steel Axle
- Rope Capacity: 1/2" (13 mm)
- Dimensions: 6.5" x 2.5"
- Weight: 0.85 lbs
- Meets NFPA/ANSI/OSHA strength specifications

SKU	SIZE	ATTRIBUTE	PRODUCT
RP119	1/2"	Aluminum	RP119 Double Rescue Pulley



ALUMINUM

## CMI 2" Stainless Steel NFPA Double Rescue Pulley



### SPECS + FEATURES

- Stainless Steel Sideplates & Axle; Two 2" Sheaves (Aluminum), Bushing, Bearing
- Rope Capacity: 1/2" (13 mm)
- Dimensions: 6.5" x 2.5"
- Weight: 0.85 lbs
- Meets NFPA/ANSI/OSHA strength specifications

SKU	SIZE	ATTRIBUTE	PRODUCT
RP120A	1/2"	Stainless	RP120A Double Pulley



STAINLESS



## DMM Pinto Pulleys



**DMM Pinto Pulleys** have a hot forged frame 7075 T6 aluminum for exceptional strength to weight ratio. The **Pinto Rig (Purple) (Large) Rigging Pulley** carries 6000-2RS series ball bearings. The **Red (small) Pinto pulley** carries an oilite bushing.

### SPECS + FEATURES

- Size of attachment holes reduce probability of locking carabiner rotation.
- Compatible with DMM Ultra O and Boa carabiners.
- Small max rope diameter: <14 mm; MBS: 40 kN (9000 lbs); WLL: 8 kN (1800 lbs); Efficiency: 71%
- Large max rope diameter 16 mm; MBS: 50 kN (11,000 lbs); WLL: 10 kN (2200 lbs); Efficiency: 95%

SKU	ATTRIBUTE	PRODUCT
PUL110	Red	Pinto Pulley Red (Small)
PUL120	Purple	Pinto Rig (Purple) (Large) Rigging Pulley



## DMM Revolver Rig Locksafe



The design of the **Revolver Rig** is such that when using a connector attached to the becket any friction between the connector and rope is minimized. It features a high efficiency roller bearing sheave(s), threaded removable captive bar and a full strength textile friendly becket.

### SPECS + FEATURES

- Single – Rope Diameter: 7-13 mm, Weight: 203 g
- Twin – Rope Diameter: 5-8 mm; Weight: 219 g
- MBS: 25 kN / WLL: 5 kN
- Size: 76 x 160 mm
- Conformance: EN12278:2007, EN362:2004

SKU	SIZE	ATTRIBUTE	PRODUCT
A5871CB-ID		Matte grey	Revolver Rig Locksafe
A5872CB	Twin	Matte grey	Revolver Rig Twin Locksafe



## BUCK BuckBully™ Pulley for 5/8" Rope



The **BuckBully** is a high strength aluminum pulley designed to be used in conjunction with the popular **OX Block™** for 5/8" synthetic rope.

### SPECS + FEATURES

- Dimensions: Length: 5.5" (140 mm) x Width: 4.5" (114 mm); Weight: 1 lb
- Features a maintenance free sealed bearing for effortless pulling
- Side plates that are hard coat anodized and laser etched
- Can accommodate up to a 5/8" rope
- Tolerance is tight enough that P-line or Mule Tape can be pulled through
- Handles loads of up to 2500 lbf
- Easily installed or removed from the rope.
- Breaking Strength: MBS – 10000 lbf / WLL – 2500 lbf

SKU	SIZE	ATTRIBUTE	PRODUCT
5007B1			BuckBully Pulley 5/8 Rope



## OX BLOCK™ by Buckingham



The **Buckingham OX BLOCK** is a rope snatch block with an integrated friction bar used for hurt man rescue, lowering loads, snubbing loads, and raising loads. It allows the rigging professional to handle loads with greater control. When lowering loads, tension is transferred from the worker to the **OX BLOCK**.

### SPECS + FEATURES

- Replaces standard handline blocks, parted blocks, and various snatch blocks.
- Greater WLL than blocks of similar size. WLL Eye to Sheave: 2500 lb; WLL Eye to Friction Bar: 1500
- Used for hauling loads and/or for rescue applications
- Max rope diameter 5/8" (16 mm)

SKU	SIZE	ATTRIBUTE	PRODUCT
50061			Ox Block



Looking for DMM Pinto Pulley Spacers, see page 149.

# carabiners

## Rock Exotica rockSteel Auto-Lock (Stainless Steel)

The **rockSteel Auto-lock** offers a smooth operating three-stage auto-locking mechanism and smooth keylock surface that won't snag your rope. Our **rockSteel** frames are CNC machined for precise fittings and exact tolerances.

### SPECS + FEATURES

- Impressively strong, yet lightweight
- Rated for inward gate force
- MBS Major Axis: 50 kN; Gate/sleeve: 16 kN (3600 lbs)
- Gate Opening: 1.2" (30 mm)
- Weight: 8.80 oz (246 gm)
- Certification: CE / ANSI / NFPA G – ANSI Z359.12 (09) and NFPA G compliant

SKU	ATTRIBUTE	PRODUCT
M31TL SILVER	Steel	rockSteel Auto-Lock Stainless Carabiner
M31TLN BLACK	Steel	rockSteel Auto-Lock Stainless Carabiner



## Rock Exotica's rockD (Stainless Steel)

**Rock Exotica's rockD Stainless Steel** is an auto-locking carabiner perfect for a wide range of outdoor rigging applications. Great alternative to using a throwball to reposition in the tree. Pairs well with HCP and mechanical devices.

### SPECS + FEATURES

- MBS: Major axis: 41 kN; Minor axis: 17 kN; Open gate: 13 kN;
- Inward against sleeve MBS: 9 kN
- Gate opening: 1.0" (25.4 mm)
- Weight: 7.81 oz (221 gm)
- Certifications: Pending CE

SKU	ATTRIBUTE	PRODUCT
C2SA	Steel	rockD stainless steel Auto Lock
C2SS	Steel	rockD stainless steel Screw Lock



## DMM 12mm Boa HMS Locksafe (Stainless Steel)

The **12mm Boa HMS** has all the versatility of its alloy sibling, but has a rated strength of 40 kN. It can be used for many applications where a large gate opening or high internal volume are required.

### SPECS + FEATURES

- Cold forged
- Weight: 277 g
- MBS: Major axis: 40 kN; Minor axis: 10 kN; Open gate: 12 kN
- Gate opening: 24 mm
- Dimensions: 76 x 123 mm
- Certification(s): EN 362:2004 B, EN EN12275:2013 B, H & K

SKU	ATTRIBUTE	PRODUCT
C857-ID	Steel	Steel 12mm Boa HMS – Light Gold





## Kong Asymmetric Non-Locking with Bar (Stainless Steel)

### SPECS + FEATURES

- Non-locking, clean Keylock nose opening – no snag opening
- Material: 316 Stainless Steel
- MBS: Major Axis: 25 kN; Minor Axis: 10 kN; Gate Open: 8 kN
- Gate Opening: 18 mm
- Dimensions: 99 x 56 mm
- Weight: 126 g

SKU	ATTRIBUTE	PRODUCT
KNG567	Non-Lock	Asymmetric Steel Non-Locking w/ Bar

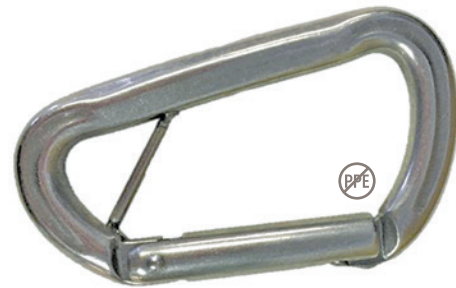

## Kong X-Large C Steel Screw Sleeve (Stainless Steel)

### SPECS + FEATURES

- Clean "keylock" gate – no snagging
- MBS: Major Axis: 50 kN; Minor Axis: 13 kN; Gate Open: 20 kN
- Weight: 240 g
- Gate Opening: 26.5mm
- CE EN 12275; CE EN 362/B; NFPA-G\*; UIAA

\*Testing done on this device satisfy the performances requirements posed by NFPA1983:2017

SKU	ATTRIBUTE	PRODUCT
KNG411SL	Keylock	X-Large C Steel Screw Sleeve



## Kong Ovalone Inox Auto Block ANSI (Stainless Steel)

### SPECS + FEATURES

- Auto Block reinforced sleeve, 3 movements
- Keylock system
- Resistant in corrosive environments
- MBS Major Axis: 27 kN
- Weight: 240 g
- CE EN 362/M; ANSI/ASSE Z359.12

SKU	ATTRIBUTE	PRODUCT
5121100K1KK		Ovalone Inox Auto Block ANSI



## Kong X-Large C Steel Auto Block ANSI (Stainless Steel)

### SPECS + FEATURES

- A reinforced sleeve offers greater resistance to lateral stress and decreases the chance of roll out (Meets ANSI Z359.12)
- Keylock nose prevents snagging
- Triple-locking gate requires three steps to open the gate
- MBS: Major Axis: 50 kN; Minor Axis: 20 kN
- Weight: 265 g
- CE EN 12275; CE EN 362/B; NFPA-G\*; ANSI/ASSE Z359.12; UIAA

\*Testing done on this device satisfy the performances requirements posed by NFPA1983:2017

SKU	ATTRIBUTE	PRODUCT
KNG411	Black	X-Large C Steel Auto Block ANSI



## Kong X-Large Twist Lock Sleeve (Aluminum Alloy)

### SPECS + FEATURES

- MBS: Major Axis: 30 kN; Minor Axis: 9 kN
- Weight: 95 g
- Gate Opening: 26 mm
- CE EN 12275; CE EN 362/B; NFPA-T\*

\*Testing done on this device satisfy the performances requirements posed by NFPA1983:2017

SKU	ATTRIBUTE	PRODUCT
110PN7VNLL	Twist-Lock	XL Steel – Orange







Travis Rusko, Sanner Tree Service, PA  
Featuring the GRCS on page 240



# rigging devices

## BUCK PORT-A-WRAP

The **Buck Port-A-Wrap** has been widely popular among the modern-day arborist, old school arborist would lower heavy wood by wrapping the lines around nearby trees causing damage to trees and often causing accidents.

### SPECS + FEATURES

- Lower heavy wood in a controlled manner
- Faster for grounds person
- User-friendly design
- Allow grounds person to be out of the drop zone completely while lowering wood to ground
- Mini - 601M (1/2 rope capacity) WLL: 1,000 lb
- Small - 601N (5/8 rope capacity) WLL: 2,000 lb
- Large - 601L Powder coated (3/4 max rope) WLL: 2,000 lb
- Large - 601LN (3/4 rope capacity) WLL: 2,000 lb

SKU	SIZE	ATTRIBUTE	PRODUCT
601M	Mini	Black	Port-A-Wrap III Steel
601N	Small	Nickel	Port-A-Wrap III Steel
601L	Large	Powder-Coated	Port-A-Wrap III Steel (Powder-Coated)
601LN	Large	Nickel	Port-A-Wrap III Steel

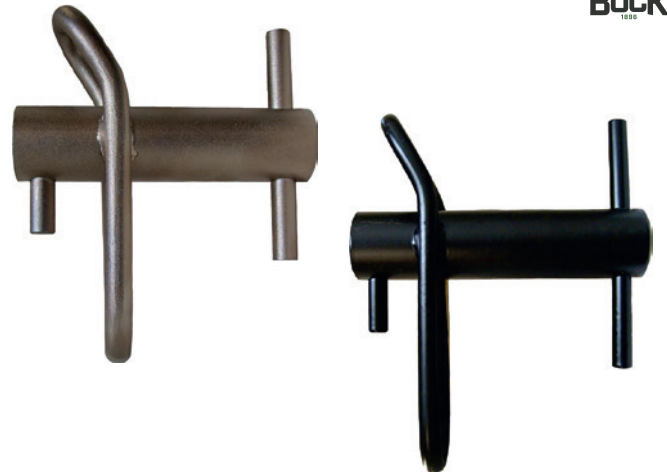

BUCKINGHAM  
**BUCK**  
1924

## US Rigging ProClimb Big 8 Aluminum Descender

This figure 8 descender is built for rescue applications. Lightweight and easy to visibly find with it's bright orange anodized finish.

### SPECS + FEATURES

- MBS: 40 kN
- Rope Size: 9 - 16 mm
- Finish: Anodized
- Weight: 9.1 oz
- Color: Orange

SKU	SIZE	ATTRIBUTE	PRODUCT
USR840	Orange	Alum	Figure 8 Rescue Ears Orange



U.S. RIGGING  
SUPPLY

## US Rigging ProClimb Big 8 Stainless Steel Descender

The **Big 8 Stainless Steel Descender** meets CE and UIAA standards and is rated at 11,240 lbs tensile strength. Made from high polished stainless steel, this descender can be used in an array of activities including arboriculture, rescue, recreational climbing and more.

### SPECS + FEATURES

- MBS: 50 kN (11,240 lbs)
- Rope Size: 11 - 16 mm
- Weight: 1.63 lbs
- Color: Silver

SKU	ATTRIBUTE	PRODUCT
USR850S	Stainless	ProClimb Big 8 Stainless Steel Descender



U.S. RIGGING  
SUPPLY

# rigging devices

RIGGING / RIGGING DEVICES

## US Rigging Fiddle Block & Fiddle Block Kit

Anodized aluminum "Uni-Body" frame, hard anodized aluminum sheaves with non-corroding Delrin ball bearings. The triple sheave system separates the rope to reduce chaffing.

### FEATURES

- Used to pull trees, logs, raise or lower loads and often to stretch fences
- 1/2" Double Braid rope 50'
- WLL 1,000 lbs
- Tensile 8,200 lbs.

SKU	SIZE	ATTRIBUTE	PRODUCT
USR-FB-DLXR		Uni-Body	Fiddle Block Set



## Rigging Shackle

### SPECS + FEATURES

- 5/8 Load Rated Screw Pin Anchor Shackle  
Working Load Limit 3-1/4 Ton  
Pin Size: .750"  
Throat Opening: 1.13"
- 3/4 Load Rated Screw Pin Anchor Shackle  
Working Load Limit 4-3/4 Ton  
Pin Size: .875"  
Throat Opening: 1.250"

SKU	SIZE	ATTRIBUTE	PRODUCT
DRSPA625	5/8"		Rigging Shackle
DRSPA750	3/4"		Rigging Shackle



## Maasdam Pow'R-Pull Rope Puller 1/2"

This rope ratchet device is used to pull trees, logs, raise or lower loads and often to stretch fences.

### SPECS + FEATURES

- The "notch-at-a-time" rope ratcheting device has a maximum capacity of 1,500 lbs and can accommodate an unlimited length of rope
- Designed to be used with 1/2" three strand rope like Pro Master or Tree Master, but can also be used with 1/2" braided ropes like Arbor Plex, True Blue or True White.
- Weight: 7.0 lbs

Rope is not included

SKU	SIZE	ATTRIBUTE	PRODUCT
A-O			Pow'R-Pull Rope Puller 1/2"
MPPHK			Replacement Handle



Caleb Mende, Certified Arborist,  
Red Squirrel Tree Care



**THE ORIGINAL PORTABLE WINCH**

## IDEAL WINCHES FOR PROFESSIONAL ARBORISTS

Model	Motor / Engine	Pulling force:	Weight:
<b>PCW3000-Li</b>	Brushless electric 1.0 kW, 82V	2,200 lb	20 lb
<b>PCW3000</b>	Honda 4-stroke GX35 all positions	1,600 lb	20 lb
<b>PCW5000</b>	Honda 4-stroke GXH50	2,200 lb	35 lb

Our surprisingly light and powerful Portable Capstan Winches are perfect for disassembling trees, directional felling, pulling logs to the truck/chipper, working over power lines, and much more...

Many anchoring possibilities, full line of accessories available.

### Portable Winch Kit PCW5000FK

The most popular choice for woodlot owners and occasional loggers, the **PCW5000-FK kit** includes the **PCW5000** winch and accessories adapted to extract logs.

It includes the skidding cone (PCA-1290), which prevents logs from getting stuck in roots, stumps and other obstacles. Its shape allows it to slide along the residual trees, thus avoiding injuries during regeneration. The 12 mm x 50 m rope allows you to reach trees where they are. As for the single pulley, it will be useful to deviate the load or to double the pulling force if need be. Combined with the 1,000-kg power offered by the winch **PCW5000**, you will obtain 2,000 kg of force!

Note: One (1) 60 mm x 2 m polyester anchor sling is included with the winch.

SKU	SIZE	ATTRIBUTE	PRODUCT
PCW5000-FK	50CC		Kit PCW5000FK



I looked at **Portable Winches** for almost 12 years. Their products made headway in the US market after being a huge hit in Canada. Then, after being challenged by my brother-in-law to remove some wood from a lake, I finally purchased the **PCW5000 Forestry kit** and put it right to work pulling logs out of a lake. Once I had the steps down to setting it up it was all GO! The **skidding cone** did exactly as they said and guided the loads around obstacles. The Honda motor was quiet and powerful. Even though the kit has everything you need to get the work done I am looking forward to further accessorizing and putting this system into higher gear. The access I have to removing logs/brush in water and on difficult slopes is unparalleled. Best ROI I've made in quite a while..."

— George M., Webster, NH



# rigging devices

RIGGING / RIGGING DEVICES

## Portable Winch PCW4000-FK **NEW**

A very popular choice for woodlot owners and occasional loggers, the **PCW4000-FK** kit includes the PCW4000 winch and accessories adapted to extract logs. It includes the skidding cone (**PCA-1290**), which prevents logs from getting stuck in roots, stumps and other obstacles. The 10 mm x 50 m rope allows you to reach trees where they are. As for the single pulley, it will be useful to deviate the load or to double the pulling force if need be. Combined with the 1,000-kg power offered by the winch **PCW4000**, you will obtain 2,000 kg of force!

**NEW FEATURE** - Quick release automatic **Anti Roll-Back Mechanism (ARM)**. As soon as you pull the rope that goes through the ARM, the centrifugal clutch activates and the winch begins to pull. As soon as the rope is released, the drum stops rotating and the automatic mechanism does its job by holding the load in position! Disengage the rope in one simple movement! Nothing's easier.

SKU	SIZE	ATTRIBUTE	PRODUCT
PCW4000-FK			PCW4000-FK

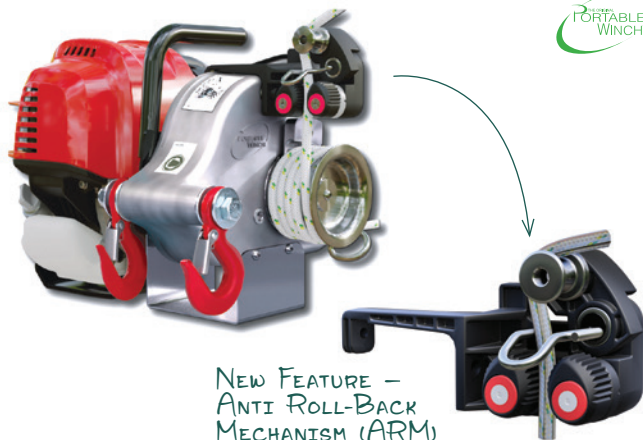

## Portable Winch Kit PCW3000FK

For a more compact choice, woodlot owners, and occasional loggers choose the kit **PCW3000-FK**, which includes the all-position winch **PCW3000** as well as a protective box and accessories adapted to extract logs.

The skidding cone (**PCA-1290**) prevents logs from getting stuck in roots, stumps and other obstacles. Its shape allows it to slide along the residual trees, thus avoiding injuries during regeneration. The 10 mm x 50 m rope allows you to reach trees where they are. The single pulley will be useful to deviate the load or to double the pulling force when the time comes. Combined with the 700-kg power offered by the winch **PCW3000**, you will get 1,400 kg of force!

Note: One (1) 60 mm x 2 m polyester anchor sling is included with the winch.

SKU	SIZE	ATTRIBUTE	PRODUCT
PCW3000-FK	35cc		Kit PCW3000FK



## Portable Winch PCW3000-LI

The **PCW3000-LI** is the simplest and fastest winch to start. Instant start with a button. Interchangeable quick-charge batteries (not included). Indoor and outdoor use. In addition, it supports 80/82 V Lithium-Ion batteries, from 2 to 6 Ah, from several major brands (see the list of compatible batteries). Depending on the selected speed, the weight of the pulled load and the chosen battery, the user benefits from a battery life ranging from 20 to 40 minutes of continuous use, without loss of power.

The **PCW3000-LI** develops a remarkable pulling force of 1,000 kg without mechanical advantage. By using a pulley system, you can go up to five times (5x) this pulling force. That is, with two double pulleys, you could pull up to 5,000 kg!

SKU	SIZE	ATTRIBUTE	PRODUCT
PCW3000-LI			PCW3000-LI



## Portable Winch Polyester Sling

### SPECS + FEATURES

- Our polyester slings can be used for many things:  
Attach our winches to an anchor point; Attach a pulley to a tree or pole; Pull a vehicle with another vehicle. And even more!
- 2 meters (6' 7-3/16")
- WLL: Straight Line 2,000 kg - 4,409 lb; Choker 1,600 kg - 3,527 lb; Basket (U) 4,000 kg - 8,818 lb

SKU	SIZE	ATTRIBUTE	PRODUCT
PCA-1260	67"		Polyester Sling - 60 mm x 2 M





## Portable Winch Double-Braided Rope



### SPECS + FEATURES

- Low stretch for increased safety. Low cost and resistance to abrasion.
- 10 mm – Use with PCW3000, PCW3000-Li, and PCW5000-HS. MBL: 4,850 lb  
– PCA-1205M – Weight: 7.7 lb; Length: 164'; Diameter: 3/8"  
– PCA-1203M – Weight: 15.4 lb; Length: 328'; Diameter: 3/8"
- 12 mm – Use with PCW5000 and PCW5000-HS. MBL: 7,275 lb  
– PCA-1215M – Weight: 12.1 lb; Length: 164'; Diameter: 1/2"  
– PCA-1213M – Weight: 24.2 lb; Length: 328'; Diameter: 1/2"

SKU	SIZE	ATTRIBUTE	PRODUCT
PCA-1205M	164'	3/8"   10 mm	Rope 10 mm X 50 M
PCA-1203M	328'	3/8"   10 mm	Rope 10 mm X 100 M
PCA-1215M	164'	1/2"   12 mm	Rope 12 mm X 50 M
PCA-1213M	328'	1/2"   12 mm	Rope 12 mm X 100 M



## Portable Winch Transport Case



Our most popular model! This transport case with molded parts is specially designed for the **PCW5000** and **PCW5000-HS** winches.

### SPECS + FEATURES

- Its molded forms secure the winch and several accessories. It is equipped with 4 elastic rubber tie-downs which hold the cover tightly.
- Cover can also be removed completely and even used under the winch when working in snow or mud. Two handles molded in the box facilitate its handling.

SKU	SIZE	ATTRIBUTE	PRODUCT
PCA-0100			Transport Case For 5000 Series



## Portable Winch Anchor Plate For Towing Balls



### SPECS + FEATURES

- Fits on tow balls up to 58.7 mm (2-5/16") in diameter and turns any vehicle into an anchor point for your winch.
- Attach the winch's hooks to the plate and simply insert it onto the tow ball.
- Can be used with models: PCW3000, PCW3000-Li, PCW5000, PCW5000-HS

SKU	SIZE	ATTRIBUTE	PRODUCT
PCA-1261			Anchor Plate For Towing Balls



## Portable Winch Log Skidding Cone



The **Skidding Cone** is ideal to use with a chipper winch, a **GRCS**, a **Portable Winch**, a skid steer, or a small tractor. Prevents logs from being stopped by roots, stumps or residual trees. Also protects your trees along a skid path.

### SPECS + FEATURES

- 51 cm (20") opening to haul large logs, bunches of smaller logs, or brush
- Use it year round, down to temperatures of -30°C (-22°F)
- Weight: 5,3 kg (11.7 lb)
- Dimensions: Diameter: 51 cm (20"); Height: 67 cm (26-1/2")

SKU	SIZE	ATTRIBUTE	PRODUCT
PCA-1290			Log Skidding Cone



## Portable Winch Transport Case



Molded location is especially designed to accommodate **PCW3000**.

### SPECS + FEATURES

- Carry and store your winch safely in this durable and robust box made of high-performance plastic!
- With a strap on each side, you can easily attach it to your vehicle. It is also meant to be attached to the PCA-0104 Molded Pack Frame in order to easily carry your winch when you are out and about.

SKU	ATTRIBUTE	PRODUCT
PCA-0102		Transport Case For 3000 Series



## Portable Winch Tree-Mount Winch Anchor System



### SPECS + FEATURES

- It is easy to install by firmly tightening the belt using the ratchet mechanism.
- Can be used with models: PCW3000, PCW3000-Li, PCW5000, PCW5000-HS

SKU	SIZE	ATTRIBUTE	PRODUCT
PCA-1269			Tree-Mount Winch Anchor System



# rigging devices

RIGGING / RIGGING DEVICES

## Portable Winch Choker Chain with C-Hook and Steel Rod



### SPECS + FEATURES

- 1/4" (6.35 mm) diameter plated steel chain
- Equipped with a C-shaped hook for quick and safe installation and disassembly.
- 30 cm steel rod allows it to be easily pushed under the logs or inserted into the opening of the skidding cone.
- Minimum Breaking Load: 56.9 kN (12,730 lb)

SKU	SIZE	ATTRIBUTE	PRODUCT
PCA-1295			Choker Chain 2.1 M



## Portable Winch Pulling Plate For Vehicles



### SPECS + FEATURES

- Designed to be inserted on a vehicle ball and to attach a synthetic rope to it.
- Straight and smooth drum ensures rope will be easily untied.
- The grip is taken near the quad's center of gravity, reducing the risk of rotation.
- Diameter: 1-5/8"

SKU	SIZE	ATTRIBUTE	PRODUCT
PCA-1310			Pulling Plate For Vehicles



## GRCS Good Rigging Control System

The **GRCS** is a device that provides significant mechanical advantage for the operator to lift, pull, delete slack, lock-off, and lower loads under constant control. No other lowering/lifting device combines the speed, power, versatility, and convenience.

### SPECS + FEATURES

- Incorporates one of the most powerful winches in the boating industry, the Harken 2-speed self-tailing rope winch
- Gear reductions of 22:1 in high gear and 44:1 in low gear
- A single person can lift upwards of 2,000 lbs!
- Winch accepts 1/2 to 3/4" diameter lowering lines.
- Unique steel frame that allows mounting on a range of tree shapes and sizes.
- Included with your system is a separate all aluminum rope brake drum that accepts ropes of any diameter.
- Weight: 85 lbs.

SKU	SIZE	PRODUCT
GRCS-TM (85#)		Good Rigging Control System
GR1003RPL	Large	Replacement Rubber Pads
GR1004RPS	Small	Replacement Rubber Pads
GRCSTA	2"	Truck Mount Adapter Assly.
GR1020V		Visor
GR1008PF		Fairlead Pigtail
GR1014PWD		Winch Driver



GR1014PWD

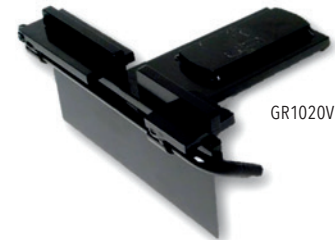

GR1020V



GRCSTA

GR1008PF





# 8 | bucket tools + accessories



FALL ARREST HARNESES.....	242
FALL ARREST LANYARDS .....	245
BUCKET COVERS.....	247
UTILITY SCABBARDS .....	248
TOOLS.....	250
PADS + MATS.....	251

Image courtesy of CAMP,  
CAMP FOCUS Full Body ANSI Vest



# fall arrest harnesses

## CAMP FOCUS Full Body ANSI Vest

A streamlined fall arrest harness featuring with an integrated padded vest that wraps around the upper body with dual certification (ANSI + EN). Proprietary ANSI STS automatic buckles on the legs loops and sternal make this harness extremely quick and easy to put on and take off.

### SPECS + FEATURES

- Equipped with 2 removable front zip pockets.
- Certified break-away parking loops for lanyards on the shoulders.
- 2 steel attachment points for fall arrest with certified load indicators: 1 sternal and 1 dorsal.
- Two gear loops.
- Weight: 1850 g, 65.3 oz
- Standard(s): EN 361 – ANSI Z359.11
- One size fits all: Waist (80-140 cm); Legs (45-75 cm); Height (50-90 cm)

SKU	SIZE	PRODUCT
2664	UNI	Focus Full Bod Vest ANSI



## CAMP FOCUS Full Body Light ANSI Harness

Basic, lightweight fall arrest harness with dual certification (ANSI + EN). Focus Light ANSI satisfies the strict regulatory needs of workers at height in many parts of the world. Proprietary ANSI STS automatic buckles on the legs loops and sternal make this harness extremely quick and easy to put on and take off.

### SPECS + FEATURES

- Certified break-away parking loops for lanyards on the shoulders.
- 2 steel attachment points for fall arrest: 1 dorsal with certified load indicator and 1 sternal (no load indicator).
- Two gear loops
- Weight: 3.14 lbs.
- Standard(s): EN 361 – ANSI Z359.11
- One size fits all: Waist (80-140 cm); Legs (45-75 cm); Height (50-90 cm)

SKU	SIZE	PRODUCT
2663	UNI	Focus Full Body Light ANSI Harness



## BUCK OSHA Harness-Lanyard Combo

### SPECS + FEATURES

- Safety Green Webbing
- H-Style harness
- Interlocking Chest & Leg Buckles to ensure comfort
- Includes 4-1/2' BuckYard Lanyard, a great value add-on.
- Material: Nylon

### SPECS

- Universal Size (Fits Medium- X-Large)
- Fall Protection: Class A (Fall Arrest/Fall Restraint)
- Standards: ANSI Z359.11, Z359.13 and ASTM F887-13 for ARC Flash.
- User Weight Capacity: 350 lbs
- Weight: 4.35 lbs

SKU	SIZE	PRODUCT
U6493706	One Size	OSHA Harness-Lanyard Combo





## BUCK Bucket Harness H-Style with Quick Clips

An H-style full body harness with a steel D dorsal attachment and split tongue quick connect buckles with leather chafes on chest and leg straps. Friction buckles are mounted on vertical shoulder strap for height adjustment.

### SPECS + FEATURES

- H-style full body harness with steel D dorsal attachment
- Split tongue quick connect buckles with leather chafes on chest and leg straps
- Friction buckles mounted on vertical shoulder strap for height adjustment
- Meets all applicable ANSI, OSHA and/or ASTM standards
- Meets ASTM Electric Arc Performance Requirements

SKU	SIZE	PRODUCT
68D98C600S H STYLE	S	H-Style Quick Clips Bucket Harness
68D98C600M H STYLE	M	H-Style Quick Clips Bucket Harness
68D98C600L H STYLE	L	H-Style Quick Clips Bucket Harness
68D98C600XL H STYLE	XL	H-Style Quick Clips Bucket Harness



## Edelrid Flex Lite Full Body Harness

### SPECS + FEATURES

- Fall indicator in the back padding; a red label becomes visible in the window in the back plate following a load of over 6 kN
- All load-bearing straps are equipped with indicator tape
- Shoulder padding with RFID pocket
- Easy Glider buckle on the shoulder straps
- Detachable leg padding
- 3D mesh with a closed surface structure
- Triple Lock buckles on the legs and hips for extra safety
- Textile fall arrest eyelets 2x type A/2 sternal and 1x A dorsal according to EN 361; remain open under preload and allow a further carabiner to be easily attached
- Standards: CE marking: CE 0123
- Sizes: S-M: 155 - 180 cm L-XXL :175 - 205 cm

SKU	SIZE	PRODUCT
880860292190	S-M	Flex Lite Full Body Harness
880860302190	L-XXL	Flex Lite Full Body Harness



## Kong Sierra Duo Bucket Harness

Kong Sierra Duo Bucket Harness changes the comfort of work positioning and fall arrest when combined with positioning Safety Belt

### SPECS + FEATURES

- Lightweight
- Practical and safe
- Economical
- Equipped with three anchor points (sternal, ventral and dorsal)
- Stainless steel buckles and dorsal attachment point
- Equipped with two wide gear loops
- Sizing: M/L - 28-41" XL - 35-51"

SKU	SIZE	PRODUCT
8W0053000KK	M/L	Kong Sierra Duo
8W0055000KK	XL	Kong Sierra Duo



# fall arrest harnesses

BUCKET, LIFTS, + CRANES / FALL ARREST HARNESSSES

## Elk River Universal 1-D Harness

### SPECS + FEATURES

- 3 steel D-rings: 1 positioned in the back of the harness and the other 2 are one positioned at each hip
- Parachute mating buckle on each chest strap
- Tongue buckles on each leg strap
- Shoulder strap adjusters
- Fall indicators
- Lanyard parks
- Constructed from polyester and nylon
- One size fits most (M-2XL)
- Fall Protection: Class A

SKU	SIZE	PRODUCT
42159	Uni	Universal 1 D Saddle w/Tongue Leg Buckles

**Elk River, Inc.**  
Personal Fall Protection



Stanley Bucket Operator NECISA 2019 by Kelly Macdonald





# fall arrest lanyards

## BUCK BuckYard Stretch™

### FEATURES

- For full body harness w/web loop dorsal attachment. Nylon web construction. User weight capacity 350 lbs.
- 1-1/2" wide strap by 6' length
- Fall rated Z-snaphook auto locking 3.6 M gate
- Will expand/stretch to 6' when worked and will retract to 44", minimizing the length of webbing the end user has while working; reducing tripping hazards.

SKU	SIZE	ATTRIBUTE	PRODUCT
84V114S1	4'		BuckYard

TOP SELLER FOR WORK  
AROUND WIRES!

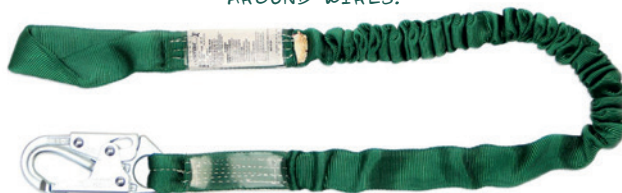

## BUCK BuckYard ASTM Lanyard – Snap to Snap

### SPECS + FEATURES

- For full body harness with dorsal steel ring. User weight capacity: 350 lbs
- Interior materials stretch to reduce the arresting force to less than 900 lbs.
- 1706 locking snap hook on both ends.
- Maximum Elongation: 48"; Maximum Free Fall: 6'
- Standards: ANSI Z359.13, ASTM F887, CSA Z259.11

SKU	LENGTH	PRODUCT
8W114.5S1	4.5'	BuckYard ASTM Lanyard
8W115S1	5'	BuckYard ASTM Lanyard
8W116S1	6'	BuckYard ASTM Lanyard



## BUCK BuckYard Stretch Lanyard – Snap to Snap

### SPECS + FEATURES

- For full body harness with dorsal steel ring. User weight capacity: 350 lbs
- Reduces the size of a 6' lanyard to about 44" reducing the chance of tripping
- 1706 locking snap hook on both ends.
- Maximum Elongation: 48"; Maximum Free Fall: 6'
- Standards: ANSI Z359.13, ASTM F887

SKU	SIZE	ATTRIBUTE	PRODUCT
8W716S1	6'		BuckYard Stretch Lanyard



## BUCK-IT Lanyard Restraint System

The easy-to-install **BUCKIT Restraint System** keeps the user secure in the bucket, while allowing freedom to move and work.

### SPECS + FEATURES

- 10,000 lb. rated nylon strap attached with a ratchet buckle and cotter pin that places the anchor point at the basket.
- 2 attachment points that attach to the workers harness or aerial belt that prevents the worker from falling or being catapulted from the basket.
- Energy absorber is attached between the BUCKIT restraint strap and the anchor point on the boom.
- Keeps the operator, basket, and the boom from hitting the ground in the event of a catastrophic separation of the bucket from the boom.
- The BUCKIT Restraint Kit includes: Retro harness strap to attach to your harness or aerial belt; Rear attachment strap; and Front attachment strap
- Ideal for single man bucket crews, trouble shooters working alone, street light crews, cable and telecom workers, and arborist working on aerial/compact lifts.

SKU	SIZE	ATTRIBUTE	PRODUCT
126A			BUCKIT Restraint System



# fall arrest lanyards

BUCKET, LIFTS, + CRANES / FALL ARREST LANYARDS

## Elk River Flex-Nopac® Energy-Absorbing Web Lanyard

Elk River, Inc.  
Personal Fall Protection

### SPECS + FEATURES

- Single leg energy-absorbing lanyard constructed with polyester web
- For full body harness w/web loop dorsal attachment.
- 1-1/2" wide strap by 6' length
- Z-snaphook auto locking 3.6 M gate
- Fall rated snap hook on each end
- Stretches 4.5' to 6'



SKU	SIZE	PRODUCT
35427	6'	Flex-Nopac Energy-Absorbing Web Lanyard

## Kong EAW I Bucket Lanyard with Tango Snap

KONG

### SPECS + FEATURES

- Energy absorber 30 mm polyamide elastic sling lanyard reduces the impact force and the risk of injuries for the operator. The energy of the fall is absorbed by the tearing of specific webbing.
- Mesh pouch Velcro protects the energy absorber from abrasion and allows regular verification of the absorber's condition with stress indicator.
- Tango Rope Snap – double locking, MBS: Long axis 32 kN, short axis 12 kN, open gate 15 kN
- Length: 5'
- Weight: 15 oz

LIGHTWEIGHT, ONLY 15 OZ



SKU	PRODUCT
201SETE05KK	EAW I Bucket Lanyard with Tango Snap 5'

## Kong EAW I Bucket Lanyard

KONG

### SPECS + FEATURES

- Energy absorber 30 mm polyamide elastic sling lanyard reduces the impact force and the risk of injuries for the operator. The energy of the fall is absorbed by the tearing of specific webbing.
- Mesh pouch Velcro protects the energy absorber from abrasion and allows regular verification of the absorber's condition with stress indicator.
- Length: 3'
- Weight: 12 oz



LIGHTWEIGHT AND ALLOWS USER TO USE THEIR OWN CONNECTING HARDWARE.

SKU	PRODUCT
201E090Y0KK	EAW I Bucket Lanyard 3'

## Sterling FCX Bucket Evacuation Kit

STERLING

### SPECS + FEATURES

- Compact, emergency egress system beneficial for arborists working alone in a lift
- Auto-locking FCX Descent Control Device with smooth modulation for easy control
- Spring-loaded handle that stays out of the way until loaded
- Nylon Sling-Water-resistant, durable low-profile storage bag can be easily secured inside the bucket and stays out of the way until needed.
- ANSI Snaphook-Aluminum ANSI-rated carabiner with captive pin
- 75' of 8.0 mm SafeTech Escape Rope (Custom SafeTech length available upon request), this kit provides a controlled evacuation when needed most
- Meets ANSI Z359.4 Self Rescue System
- Weight: 3.95 lb



SKU	PRODUCT
KTFCXST23B	FCX Bucket Rescue Kit



# bucket covers

## Weaver Bucket Cover



This aerial **bucket cover** from **Weaver** is made of heavy gauge vinyl and includes a sewn-in bungee cord with a snap. Keeps water, dirt, and debris out of your bucket.

### SPECS + FEATURES

- This cover fits single person buckets
- Runs large in size

SKU	SIZE	ATTRIBUTE	PRODUCT
0807195			Weaver Bucket Cover



## BUCK Bucket Cover



**Buckingham's 50" bucket cover** is a larger vinyl coated nylon bucket cover that is made to fit two-man baskets.

### SPECS + FEATURES

- Heavy-duty sewn in bungee cord and snap to secure itself to the bucket.
- Includes one grommet hole.

SKU	SIZE	ATTRIBUTE	PRODUCT
4545B3	50" x 50"	Black	Bucket Cover 50"
4545-O	50" x 50"	Orange	Bucket Cover 50"

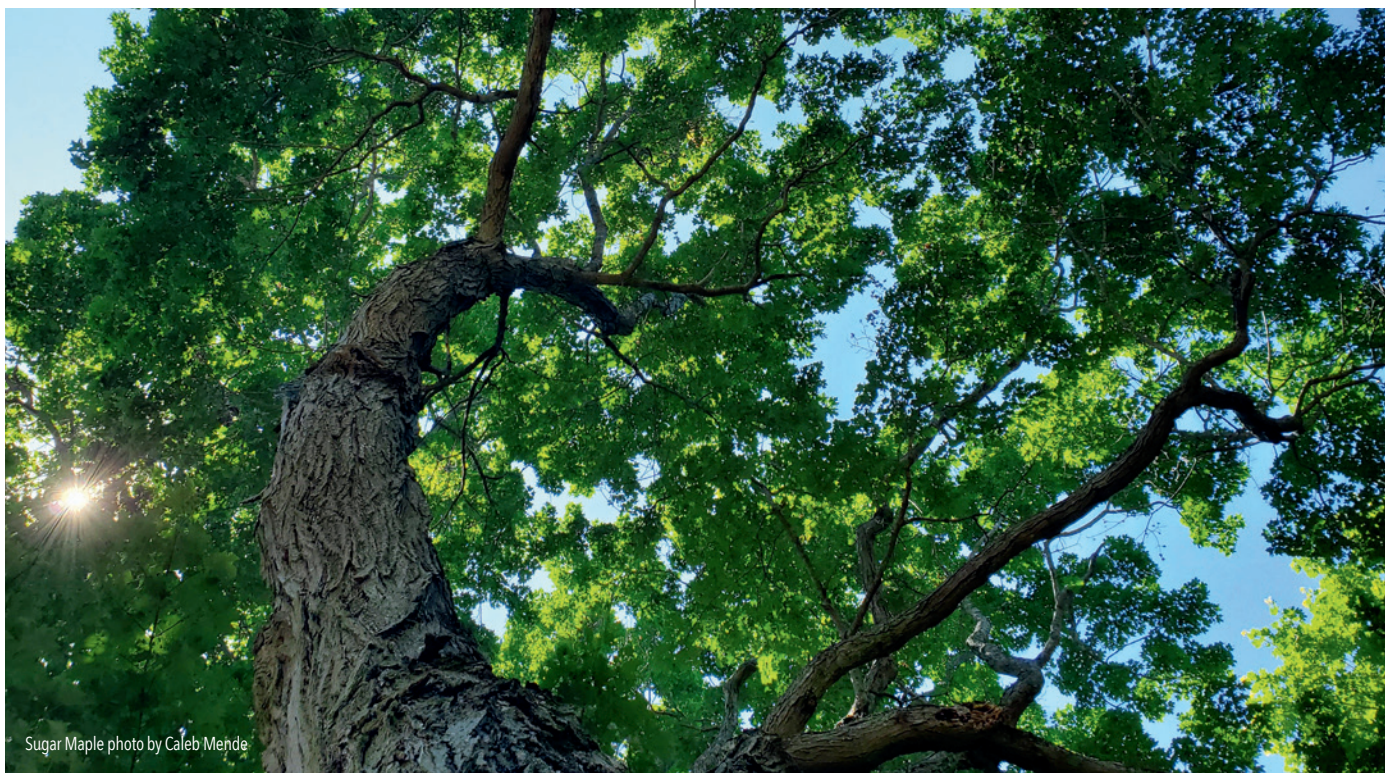

Sugar Maple photo by Caleb Mende



# utility scabbards

## SafeTree Chainsaw Scabbard – Inside or Outside Mount

SafeTree's rugged scabbard constructed from a UV stabilized, virtually indestructible revolutionary material. SafeTree's scabbard pocket insures that your sharp blades stay sharp but do not harm the worker. Providing maximum accessibility, maneuverability, and safety in the work space.

### SPECS + FEATURES

- Exterior or Interior mounting on the utility bucket.
- Features unique under-rail clip that locks the scabbard to the utility bucket
- Will not damage or dull the cutting edge of your blade.
- Will not fracture, splinter, or break apart.

SKU	SIZE	ATTRIBUTE	PRODUCT
0140UCSSY	Bucket	Yellow	Outside Mount Bucket Scabbard
0111NCSSY	Bucket	Yellow	Inside Mount Bucket Scabbard
0151NOUTRP	Pocket	5 1/2"	Scabbard Replacement Pocket
1EL15-6	Strap		Scabbard Straps



## SafeTree Stick Saw Holder with Straps

SafeTree's Stick Saw Holder is constructed from a UV stabilized, virtually indestructible revolutionary material. Protect your equipment while operating an aerial bucket. Utilizing the same Safe Tree technology

### SPECS + FEATURES

- Both ends are open, allowing user to flip it around to use the other side when one side wears out
- Twice the life of others on the market
- Ratchet straps included

SKU	SIZE	PRODUCT
016SSBHWS	Boom	Stick Saw Holder with Straps

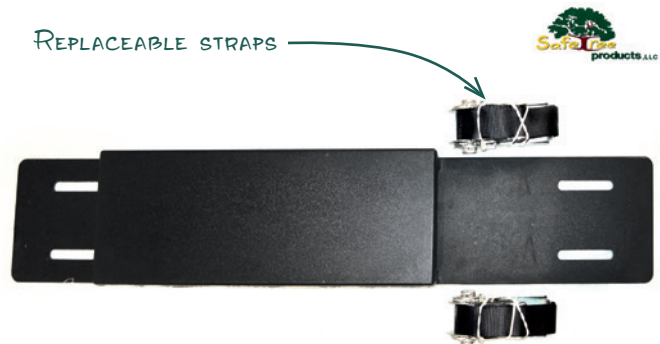

## SafeTree Chainsaw Scabbard – Pipe Mount

SafeTree Chainsaw Scabbard for Lifts with pipe railings protect the arborist and ensure that your blades stay sharp. These scabbards are made out of heavy-duty material that will not damage or dull the cutting edge of your chain. It will not fracture, splinter, or break apart but it will provide maximum accessibility, maneuverability, and safety in the work space.

### SPECS + FEATURES

- Constructed from a UV stabilized, virtually indestructible revolutionary material.
- Fits any model of chainsaw
- Weighs 7.5 lbs.

SKU	SIZE	ATTRIBUTE	PRODUCT
0131NCSSPY	Pipe	Black/Yellow	Scabbard Chainsaw Pipe





## SafeTree Scabbard Chain & Handsaw Inside

**SafeTree Chainsaw & Handsaw Pipe or Bucket Scabbard** – Same great scabbard but now included with a spot for your handsaw; makes it easy to be compliant with the Z133 Standard. All in one scabbard for your chainsaw and your handsaw!

SKU	SIZE	ATTRIBUTE	PRODUCT
012INCSSWHY	Bucket	Yellow	Scabbard Chain & Handsaw Inside
012INCSSWHR	Bucket	Red	Scabbard Chain & Handsaw Inside
012INCSSWHO	Bucket	Orange	Scabbard Chain & Handsaw Inside
012INCSSPWHY	Pipe	Yellow	Scabbard Chain & Handsaw Inside
012INCSSPWHG	Pipe	Green	Scabbard Chain & Handsaw Inside



BUCKET OR PIPE MOUNT

## SafeTree Bucket Stick Saw Holder ADI

**Outside Mounted Stick Saw Holder for ADI hydraulic saw**



SKU	SIZE	ATTRIBUTE	PRODUCT
016SSADIH	Oval	Full	Bucket Stick Saw Holder ADI



## SafeTree Bucket Polesaw Holder Jameson



### SPECS + FEATURES

- Mounts on outside of bucket
- Fits round handle stick/pole saws

SKU	SIZE	ATTRIBUTE	PRODUCT
016PSJAMH	Round	Full	Bucket Polesaw Holder Jameson



## Jameson Chainsaw Holder Long Reach

### SPECS + FEATURES

- Made from high impact plastic
- Rubberized liner allows you to mount your Stick Saw to the boom for safety and easy access.
- Fits Greenlee Fairmont style long reach chainsaw.
- Comes complete with 24-04R handle unit.
- Dimensions: 32" x 5"
- Includes nylon ratcheting straps to fix a position on any round or square booms.

SKU	SIZE	ATTRIBUTE	PRODUCT
24-03F			Chainsaw Holder Long Reach



## Jameson Pole Pruner Bag 6.5'

Heavy duty vinyl bag conveniently carries poles and protects them during transport or storage.

### SPECS + FEATURES

- Four 6' pole pockets
- Outside pruner head pocket
- Carrying straps
- Weight: 3.6 lbs

SKU	SIZE	ATTRIBUTE	PRODUCT
B-6V		Yellow	Pole Pruner Bag 6.5'



# tools

## Jameson Hydraulic Pruner Boom Mount with Ratchet

The 24-04R from **Jameson** is a replacement handle unit for **Jameson's Hydraulic Pruner Holder with Locking Straps**. Take the tools out of the bucket and mount them on the boom for safe, convenient access.

### SPECS + FEATURES

- Made from high impact plastic
- Jameson's boom-mount tool holders can be strapped to round or square booms.
- Includes: Handle, strap, and ratchet

SKU	SIZE	ATTRIBUTE	PRODUCT
24-04R			Hydr Pruner Boom Mount Holder



## BUCK Bucket Boom Strap w/Ratchet

The **Ratchet Boom Strap** is designed to be used when your aerial boom truck has no anchor point, or your anchor point is in an inconvenient location. The inside of the strap is lined with gum rubber to eliminate slippage on the boom. A ratchet is used to cinch the strap snugly on the boom.

- Standard length is 50"
- Rated to 5,000 lbs

SKU	SIZE	ATTRIBUTE	PRODUCT
3809R			Bucket Boom Strap w/Ratchet



## BUCK Canvas Cable Bucket

A canvas bucket made with heavy canvas construction with a solid continuous PVC ring in top and has a molded rubber bottom. A polypropylene rope with 4958 brass swivel snap. Will not rot from use in the sun and rain.

### SPECS + FEATURES

- Hard Bottom and Lead Snap
- 8" x 8" Inside pocket
- Sliced for added durability.
- Reinforced rope support holes to prevent wear on canvas.
- Heavy duty Nylon thread that will not rot or fall apart.
- Unique heavy canvas construction that is folded over outside stitches to protect thread from abrasion.

SKU	PRODUCT
005954	Cable Bucket Hard Bottom



## BUCK Buckeye Bucket Hook with Tether

Patent-pending bucket hook can fit up to a 2 1/2" bucket lip and now features a tool tether connection eye. The tether connection eye allows for the **Buck Tool Tether** (included) to be attached for extra tool fall protection. Tool tether is 51" in length.

### SPECS + FEATURES

- Outside hook with a 2 1/2" hook opening and a 40 lb. WLL (3:1 safety factor)
- Two inside accessory hooks with a 15 lb. WLL (3:1 safety factor)
- 3/4" inside opening- The duo hooks on the inside are great for storing extra slings, blocks, tools, etc.

SKU	PRODUCT
2410GT	Buckeye Bucket Hook with Tether





# pads + mats

## Bigfoot Ultra Outrigger Pad

Bigfoot provides a very strong, durable, and cost-effective footing for all your rigging applications. Applications for our outrigger pads include: cranes, bucket trucks, utility trucks, fire trucks, concrete pumps, any type of aerial equipment

### SPECS + FEATURES

- UHMW Plastic or Wood (Baltic Birch, Plywood, Laminated, Bolted) making them non-conductive
- Easy-to-Clean, Chemical & Oil Resistant
- Storage-Friendly
- Durable & Long Lasting
- Rope Handles
- Lifetime Guarantee
- 36 x 36 x 1" - Black square, Sq Inches 1,296; Weight 45 lbs; Vert. Load Cap. 93,000; 45° Load Cap. 43,000; Crush Rate 200
- 18 x 18 x 1" - Orange square, Sq Inches 324; Weight 11 lbs; Vert. Load Cap. 55,000; 45° Load Cap. 26,000; Crush Rate 200
- 24 x 24 x 1" - Orange square, Sq Inches 576; Weight 20 lbs; Vert. Load Cap. 60,000; 45° Load Cap. 30,000; Crush Rate 200
- 24 x 24 x 2" - Orange square, Sq Inches 576; Weight 40 lbs; Vert. Load Cap. 80,000; 45° Load Cap. 40,000; Crush Rate 500
- 20 x 20 x 2" - Wood square, Weight 21 lbs

SKU	SIZE	ATTRIBUTE	PRODUCT
P363610 BLK	36x36x1"	Black	Outrigger 1" Pad
P181810 S.O.	18x18x1"	Orange	Outrigger 1" Pad
P242410 S.O.	24x24x1"	Orange	Outrigger 1" Pad
P242420 S.O.	24x24x2"	Orange	Outrigger 2" Pad
W202020	20x20x2"	Wood	Outrigger 2" Pad Wood



GREAT HI-VIZ COLOR



CAN BE ENGRAVED WITH YOUR COMPANY NAME BY SPECIAL ORDER.

## AlturnaMATS

They withstand vehicles weighing up to 60 tons, bend but do not break and they feature a Limited Lifetime Warranty. **AlturnaMATS** have been tested in record cold and heat. With **AlturnaMATS**, getting stuck is virtually eliminated.

### SPECS + FEATURES

- Rugged 1/2" thick recycled polyethylene so they are virtually indestructible
- Max Traction Diamond Plate Tread Design
- Mats can be locked together with Turn-A-Links forming a continuous roadway or workable platform in minutes
- Available smooth on one side or smooth on both sides
- Simply hosing down leaves the mats clean
- MatPak<sup>®</sup> includes 12 Mats, 20 Connecting Links, 2 Handi Hooks, 2 Ratchet Straps, and Carrying Frame

SKU	SIZE	ATTRIBUTE	PRODUCT
CMCP4	4X8	Clear	MatPak <sup>®</sup> 1126 lbs
AMCP3S1 SMOOTH ONE SIDE	3X8	Black	MatPak <sup>®</sup> 868 lbs
AMCP4S1 SMOOTH ONE SIDE	4X8	Black	MatPak <sup>®</sup> 1126 lbs
CMCP4S1 SMOOTH ONE SIDE	4X8	Clear	MatPak <sup>®</sup> 1126 lbs
CMCP3S1 SMOOTH ONE SIDE	3X8	Clear	MatPak <sup>®</sup> 868 lbs
AM48S1	4X8	Black	Single Mat 86 lbs
AM38S1	3X8	Black	Single Mat 64 lbs
CM48S1	4X8	Clear	Single Mat 86 lbs
CM38S1	3X8	Clear	Single Mat 64 lbs

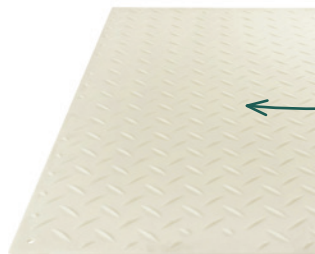

GREAT FOR TURF SENSITIVE JOBS

ASK ABOUT OUR DROP SHIP PROGRAM

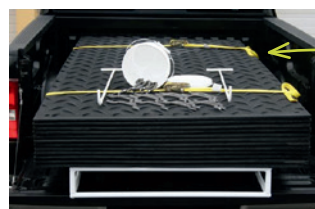

MATPAK-12 MATS, 20 CONNECTING LINKS, 2 HANDI HOOKS, 2 RATCHET STRAPS, AND CARRYING FRAME

# tools, pads, + mats

BUCKET, LIFTS, + CRANES / CHAINSAW SCABBARDS

## AlturnaMATS VersaMAT® Cleated Pak



**VersaMAT** features a low-profile slip-resistant traction surface making it ideal for pedestrian applications. The standard **VersaMAT** has the aggressive **AlturnaMATS** tread on one side but is also available with a smooth surface making it truly versatile.

### SPECS + FEATURES

- Leaves turf smooth even in soft soil conditions
- Tough 1/2" thick recycled polyethylene
- Two practical cleat designs, for walking and vehicle traffic
- Withstands 120-ton loads
- Build a temporary roadway or walkway in minutes
- Lock together with Turn-A-Links or EZ links
- Weighs 86 lbs (39 kg) at its maximum size, VersaMAT can be deployed by hand.
- Limited Lifetime Warranty



SKU	SIZE	ATTRIBUTE	PRODUCT
VMCP3 3X8	3X8	Both Sides	VersaMAT Cleated Pak

## AlturnaMATS Handi-Hook 3'



The **AlturnaMATS Handi-Hook** is the easy way to move **AlturnaMATS** around the work site. Simply hook into holes in the mats and move them easily.

### SPECS + FEATURES

- 2 Handi-Hooks come standard with MatPak kits.
- Length: 3 ft

SKU	SIZE	ATTRIBUTE	PRODUCT
AMHH			AlturnaMATS Handled Hook 3'



## AlturnaMATS Turn-A-Link



Link your mats to create a continuous path and secure from slipping.

### SPECS + FEATURES

- 20 single links come standard with MatPak kits.
- Double link adds an extra "lock in" value to connect mats

SKU	SIZE	ATTRIBUTE	PRODUCT
RTL-S-G	Single		AlturnaMATS Turn-A-Link
RTL-D-G	Double		AlturnaMATS Turn-A-Link





# 9 | forestry



CHAINS .....	254
BARs.....	258
ACCESSORIES .....	264
SPARK PLUGS .....	267
FUEL .....	268
CHAIN GRINDERS .....	274

# chains

## Oregon PowerCut .325" Chisel LPX



Oregon's PowerCut is the ultimate saw chain and guide bar for tree care professionals. Full chisel cutters power through timber with speed, efficiency, and precision. Chrome-moly steel means reduced wear for a longer-lasting guide bar.

Low-vibration, full chisel cutters. Engineered with offset depth gauges to prevent cutters from driving into the sidewall of the cut.

Available Gauges: 20 (0.050), 21 (0.058), 22 (0.063) LPX



SKU	PITCH	GAUGE	TYPE	CUTTER	PRODUCT
20LPX066G	.325"	.050"	20LPX	Chisel	PowerCut Chain
20LPX072G	.325"	.050"	20LPX	Chisel	PowerCut Chain
20LPX078G	.325"	.050"	20LPX	Chisel	PowerCut Chain
20LPX080G	.325"	.050"	20LPX	Chisel	PowerCut Chain
20LPX081G	.325"	.050"	20LPX	Chisel	PowerCut Chain
21LPX056G	.325"	.058"	21LPX	Chisel	PowerCut Chain
21LPX072G	.325"	.058"	21LPX	Chisel	PowerCut Chain
22LPX062G	.325"	.063"	22LPX	Chisel	PowerCut Chain
22LPX067G	.325"	.063"	22LPX	Chisel	PowerCut Chain
22LPX068G	.325"	.063"	22LPX	Chisel	PowerCut Chain
22LPX074G	.325"	.063"	22LPX	Chisel	PowerCut Chain
22LPX081G	.325"	.063"	22LPX	Chisel	PowerCut Chain
20LPX025U	.325"	.050"	20LPX	Chisel	PowerCut Chain Reel
20LPX100U	.325"	.050"	20LPX	Chisel	PowerCut Chain Reel
22LPX025U	.325"	.063"	22LPX	Chisel	PowerCut Chain Reel
22LPX100U	.325"	.063"	22LPX	Chisel	PowerCut Chain Reel

## Oregon PowerCut 3/8" Chisel EXL/EXJ



Low-vibration, full chisel cutter chain engineered to reduce the force applied by the operator. This chain type gives users a more durable cutting edge and increased cutting performance with less effort.

Available Gauges: 72 (0.050), 73 (0.058), 75 (0.063) EXL; 72 (0.050), 73 (0.058), 75 (0.063) EXJ



SKU	PITCH	GAUGE	TYPE	CUTTER	PRODUCT
72EXL060G	3/8"	.050"	72EXL	Chisel	PowerCut Chain
72EXL064G	3/8"	.050"	72EXL	Chisel	PowerCut Chain
72EXL066G	3/8"	.050"	72EXL	Chisel	PowerCut Chain
72EXL068G	3/8"	.050"	72EXL	Chisel	PowerCut Chain
72EXL070G	3/8"	.050"	72EXL	Chisel	PowerCut Chain
72EXL072G	3/8"	.050"	72EXL	Chisel	PowerCut Chain
72EXL081G	3/8"	.050"	72EXL	Chisel	PowerCut Chain
72EXL084G	3/8"	.050"	72EXL	Chisel	PowerCut Chain
72EXL091G	3/8"	.050"	72EXL	Chisel	PowerCut Chain
72EXL093G	3/8"	.050"	72EXL	Chisel	PowerCut Chain
72EXL105G	3/8"	.050"	72EXL	Chisel	PowerCut Chain
72EXL114G	3/8"	.050"	72EXL	Chisel	PowerCut Chain
72EXJ068G	3/8"	.050"	72EXJ	Chisel	PowerCut Chain - Skip Seq
72EXJ072G	3/8"	.050"	72EXJ	Chisel	PowerCut Chain - Skip Seq
72EXJ084G	3/8"	.050"	72EXJ	Chisel	PowerCut Chain - Skip Seq
72EXJ091G	3/8"	.050"	72EXJ	Chisel	PowerCut Chain - Skip Seq
72EXJ093G	3/8"	.050"	72EXJ	Chisel	PowerCut Chain - Skip Seq
72EXJ105G	3/8"	.050"	72EXJ	Chisel	PowerCut Chain - Skip Seq
72EXL100U	3/8"	.050"	72EXL	Chisel	PowerCut Chain Reel
72EXJ100U	3/8"	.050"	72EXJ	Chisel	PowerCut Chain - Skip Seq Reel

## Oregon PowerCut 3/8" Chisel LPX/JPX

Low-vibration, full chisel cutter chain engineered to reduce the force applied by the operator. This chain type gives users a more durable cutting edge and increased cutting performance with less effort.

Available Gauges: 72 (0.050), 73 (0.058), 75 (0.063) LPX ; 72 (0.050) JPX

SKU	PITCH	GAUGE	TYPE	CUTTER	PRODUCT
72LPX060G	3/8"	.050"	72LPX	Chisel	PowerCut Chain
72LPX064G	3/8"	.050"	72LPX	Chisel	PowerCut Chain
72LPX066G	3/8"	.050"	72LPX	Chisel	PowerCut Chain
72LPX068G	3/8"	.050"	72LPX	Chisel	PowerCut Chain
72LPX070G	3/8"	.050"	72LPX	Chisel	PowerCut Chain
72LPX071G	3/8"	.050"	72LPX	Chisel	PowerCut Chain
72LPX072G	3/8"	.050"	72LPX	Chisel	PowerCut Chain
72LPX081G	3/8"	.050"	72LPX	Chisel	PowerCut Chain
72LPX084G	3/8"	.050"	72LPX	Chisel	PowerCut Chain
72LPX093G	3/8"	.050"	72LPX	Chisel	PowerCut Chain
72LPX105G	3/8"	.050"	72LPX	Chisel	PowerCut Chain
72LPX114G	3/8"	.050"	72LPX	Chisel	PowerCut Chain



SKU	PITCH	GAUGE	TYPE	CUTTER	PRODUCT
73LPX060G	3/8"	.058"	73LPX	Chisel	PowerCut Chain
73LPX064G	3/8"	.058"	73LPX	Chisel	PowerCut Chain
73LPX068G	3/8"	.058"	73LPX	Chisel	PowerCut Chain
73LPX072G	3/8"	.058"	73LPX	Chisel	PowerCut Chain
73LPX084G	3/8"	.058"	73LPX	Chisel	PowerCut Chain
75LPX072G	3/8"	.063"	75LPX	Chisel	PowerCut Chain
72JPX072G	3/8"	.050"	72JPX	Chisel	PowerCut Chain - Skip Seq
72JPX084G	3/8"	.050"	72JPX	Chisel	PowerCut Chain - Skip Seq
72LPX100U	3/8"	.050"	72LPX	Chisel	PowerCut Chain Reel
73LPX100U	3/8"	.058"	73LPX	Chisel	PowerCut Chain Reel
75LPX100U	3/8"	.063"	75LPX	Chisel	PowerCut Chain Reel
72JPX100U	3/8"	.050"	72JPX	Chisel	PowerCut Chain - Skip Seq Reel



## Oregon SpeedCut .325" Micro-Chisel TXL

**OREGON**

Ideal for woodcutters who want top performance. **Oregon SpeedCut 95 (0.050) TXL** narrow kerf cutting systems are more efficient, needing less power from the saw than standard cutting systems.



SKU	PITCH	GAUGE	CUTTER	PRODUCT
95TXL062G	.325"	.050"	Micro-Chisel	SpeedCut Chain
95TXL064G	.325"	.050"	Micro-Chisel	SpeedCut Chain
95TXL066G	.325"	.050"	Micro-Chisel	SpeedCut Chain
95TXL067G	.325"	.050"	Micro-Chisel	SpeedCut Chain
95TXL068G	.325"	.050"	Micro-Chisel	SpeedCut Chain
95TXL072G	.325"	.050"	Micro-Chisel	SpeedCut Chain
95TXL074G	.325"	.050"	Micro-Chisel	SpeedCut Chain
95TXL078G	.325"	.050"	Micro-Chisel	SpeedCut Chain
95TXL080G	.325"	.050"	Micro-Chisel	SpeedCut Chain
95TXL100U	.325"	.050"	Micro-Chisel	SpeedCut Chain Reel

## Oregon SpeedCut .325" Nano Low Profile TXL

**OREGON**

**SpeedCut Nano** has been engineered from the ground up with maximum efficiency in mind. Built to optimize saw performance, **SpeedCut Nano** is the first .325" Low Profile system and meets the demands of tree care professionals like no other on the market.

**80 (0.043) TXL** – must be used together with the corresponding guide bar and sprocket and is not compatible with other existing cutting systems.

### SPECS + FEATURES

- The new generation narrow-kerf chain
- Faster – more speed, less effort with a reshaped cutter and narrow kerf design
- Sharper – sharp and ready right out of the box thanks to the new cutter design and grind technology
- Stronger – cutting surface that stays sharp longer increased uptime with easy-to-file cutter shape that stays sharp longer



SKU	PITCH	GAUGE	CUTTER	PRODUCT
80TXL046G	.325" Low Profile	.043"	Nano Chain	SpeedCut Chain
80TXL051G	.325" Low Profile	.043"	Nano Chain	SpeedCut Chain
80TXL059G	.325" Low Profile	.043"	Nano Chain	SpeedCut Chain
80TXL064G	.325" Low Profile	.043"	Nano Chain	SpeedCut Chain

## Oregon ControlCut 1/4" AP

**OREGON**

**ControlCut** saw chain was specifically engineered for light-duty jobs that demand smooth and precise cuts. **ControlCut** is available in a number of pitches and gauges to fit on a variety of chainsaws.

Available Gauges: 25 (0.050) AP



SKU	PITCH	GAUGE	TYPE	CUTTER	PRODUCT
25AP058G	1/4"	.050"	25AP	Micro-Chisel	ControlCut Chain
25AP100U	1/4"	.050"	25AP	Micro-Chisel	ControlCut Chain Reel

## Oregon VersaCut™ 3/8" Low Profile VXL

**OREGON**

**VersaCut 91 (0.050) VXL** saw chain is engineered with semi-chisel cutter top plates that are 33% longer than standard saw chain. **VersaCut** is available in a range of pitches and gauges to fit on a variety of chainsaws.

### SPECS + FEATURES

- Designed for maximum performance in a variety of cutting applications
- All chain types have low vibration for smoother cuts and less fatigue
- 33% longer top plates than standard chain



SKU	PITCH	GAUGE	CUTTER	PRODUCT
91VXL039G	3/8" Low Profile	.050"	Semi-Chisel	VersaCut Chain
91VXL044G	3/8" Low Profile	.050"	Semi-Chisel	VersaCut Chain
91VXL045G	3/8" Low Profile	.050"	Semi-Chisel	VersaCut Chain
91VXL050G	3/8" Low Profile	.050"	Semi-Chisel	VersaCut Chain
91VXL052G	3/8" Low Profile	.050"	Semi-Chisel	VersaCut Chain
91VXL053G	3/8" Low Profile	.050"	Semi-Chisel	VersaCut Chain
91VXL054G	3/8" Low Profile	.050"	Semi-Chisel	VersaCut Chain
91VXL055G	3/8" Low Profile	.050"	Semi-Chisel	VersaCut Chain
91VXL056G	3/8" Low Profile	.050"	Semi-Chisel	VersaCut Chain
91VXL057G	3/8" Low Profile	.050"	Semi-Chisel	VersaCut Chain
91VXL060G	3/8" Low Profile	.050"	Semi-Chisel	VersaCut Chain
91VXL062G	3/8" Low Profile	.050"	Semi-Chisel	VersaCut Chain
91VXL100U	3/8" Low Profile	.050"	Semi-Chisel	VersaCut Chain

## Oregon VersaCut™ 3/8" DPX/APX

**OREGON**

**VersaCut** saw chain is engineered with semi-chisel cutter top plates that are 33% longer than standard saw chain. **VersaCut** is available in a range of pitches and gauges to fit on a variety of chainsaws.

Available Gauges: 72 (0.050), 73 (0.058) DPX ; 72 (0.063) APX



SKU	PITCH	GAUGE	TYPE	CUTTER	PRODUCT
72DPX072G	3/8"	.050"	72DPX	Semi-Chisel	VersaCut – Standard
72DPX084G	3/8"	.050"	72DPX	Semi-Chisel	VersaCut – Standard
72DPX100U	3/8"	.050"	72DPX	Semi-Chisel	VersaCut – Standard Reel
72APX100U	3/8"	.063"	72APX	Semi-Chisel	VersaCut – Skip Seq Reel



Dover Oak Arbor Day 2017

## Oregon ControlCut .325" BPX



**ControlCut** saw chain was specifically engineered for light-duty jobs that demand smooth and precise cuts. **ControlCut** is available in a number of pitches and gauges to fit on a variety of chainsaws.

Available Gauges: 20 (0.050), 21 (0.058), 22 (0.063) BPX



SKU	PITCH	GAUGE	TYPE	CUTTER	PRODUCT
20BPX062G	.325"	.050"	20BPX	Micro-Chisel	ControlCut Chain
20BPX066G	.325"	.050"	20BPX	Micro-Chisel	ControlCut Chain
20BPX067G	.325"	.050"	20BPX	Micro-Chisel	ControlCut Chain
20BPX072G	.325"	.050"	20BPX	Micro-Chisel	ControlCut Chain
20BPX074G	.325"	.050"	20BPX	Micro-Chisel	ControlCut Chain
20BPX078G	.325"	.050"	20BPX	Micro-Chisel	ControlCut Chain
20BPX080G	.325"	.050"	20BPX	Micro-Chisel	ControlCut Chain
20BPX081G	.325"	.050"	20BPX	Micro-Chisel	ControlCut Chain
21BPX056G	.325"	.058"	21BPX	Micro-Chisel	ControlCut Chain
21BPX064G	.325"	.058"	21BPX	Micro-Chisel	ControlCut Chain
21BPX066G	.325"	.058"	21BPX	Micro-Chisel	ControlCut Chain
21BPX072G	.325"	.058"	21BPX	Micro-Chisel	ControlCut Chain
21BPX076G	.325"	.058"	21BPX	Micro-Chisel	ControlCut Chain
21BPX078G	.325"	.058"	21BPX	Micro-Chisel	ControlCut Chain
22BPX062G	.325"	.063"	22BPX	Micro-Chisel	ControlCut Chain
22BPX067G	.325"	.063"	22BPX	Micro-Chisel	ControlCut Chain
22BPX068G	.325"	.063"	22BPX	Micro-Chisel	ControlCut Chain
22BPX074G	.325"	.063"	22BPX	Micro-Chisel	ControlCut Chain
22BPX081G	.325"	.063"	22BPX	Micro-Chisel	ControlCut Chain
20BPX100U	.325"	.050"	20BPX	Micro-Chisel	ControlCut Chain Reel
21BPX100U	.325"	.058"	21BPX	Micro-Chisel	ControlCut Chain Reel
22BPX100U	.325"	.063"	22BPX	Micro-Chisel	ControlCut Chain Reel

## Oregon ControlCut 3/8" Low Profile PXL



**ControlCut 91 (0.050) PXL** saw chain was specifically engineered for light-duty jobs that demand smooth and precise cuts. **ControlCut** is available in a number of pitches and gauges to fit on a variety of chainsaws.



SKU	PITCH	GAUGE	CUTTER	PRODUCT
91PXL039G	3/8" Low Profile	.050"	Semi-Chisel	ControlCut Chain
91PXL044G	3/8" Low Profile	.050"	Semi-Chisel	ControlCut Chain
91PXL045G	3/8" Low Profile	.050"	Semi-Chisel	ControlCut Chain
91PXL050G	3/8" Low Profile	.050"	Semi-Chisel	ControlCut Chain
91PXL052G	3/8" Low Profile	.050"	Semi-Chisel	ControlCut Chain
91PXL055G	3/8" Low Profile	.050"	Semi-Chisel	ControlCut Chain
91PXL056G	3/8" Low Profile	.050"	Semi-Chisel	ControlCut Chain
91PXL057G	3/8" Low Profile	.050"	Semi-Chisel	ControlCut Chain
91PXL062G	3/8" Low Profile	.050"	Semi-Chisel	ControlCut Chain
91PXL100U	3/8" Low Profile	.050"	Semi-Chisel	ControlCut Chain Reel

## Oregon AdvanceCut 3/8" Low Profile PX



**AdvanceCut 90 (0.043) PX** is engineered for landscape professionals who occasionally cut wood. **Oregon's AdvanceCut** chainsaw chain delivers the same durability and performance as other **Oregon** chain while delivering ease of use with a low kickback design.



SKU	PITCH	GAUGE	CUTTER	PRODUCT
90PX034G	3/8" Low Profile	.043"	Chamfer Chisel	AdvanceCut Chain
90PX039G	3/8" Low Profile	.043"	Chamfer Chisel	AdvanceCut Chain
90PX040G	3/8" Low Profile	.043"	Chamfer Chisel	AdvanceCut Chain
90PX044G	3/8" Low Profile	.043"	Chamfer Chisel	AdvanceCut Chain
90PX045G	3/8" Low Profile	.043"	Chamfer Chisel	AdvanceCut Chain
90PX050G	3/8" Low Profile	.043"	Chamfer Chisel	AdvanceCut Chain
90PX052G	3/8" Low Profile	.043"	Chamfer Chisel	AdvanceCut Chain
90PX055G	3/8" Low Profile	.043"	Chamfer Chisel	AdvanceCut Chain
90PX056G	3/8" Low Profile	.043"	Chamfer Chisel	AdvanceCut Chain
90PX100U	3/8" Low Profile	.043"	Chamfer Chisel	AdvanceCut Chain Reel

## Oregon AdvanceCut 3/8" V



**AdvanceCut** is engineered for landscape professionals who occasionally cut wood. **Oregon's AdvanceCut** chainsaw chain delivers the same durability and performance as other **Oregon** chain while delivering ease of use with a low kickback design.

Available Gauges: 72 (0.050), 73 (0.058), 75 (0.063) V















SKU	PITCH	GAUGE	TYPE	CUTTER	PRODUCT
72V060G	3/8"	.050"	72V	Chisel	AdvanceCut Chain
72V066G	3/8"	.050"	72V	Chisel	AdvanceCut Chain
72V068G	3/8"	.050"	72V	Chisel	AdvanceCut Chain
72V070G	3/8"	.050"	72V	Chisel	AdvanceCut Chain
72V072G	3/8"	.050"	72V	Chisel	AdvanceCut Chain
72V084G	3/8"	.050"	72V	Chisel	AdvanceCut Chain
72V025U	3/8"	.050"	72V	Chisel	AdvanceCut Chain Reel
72V100U	3/8"	.050"	72V	Chisel	AdvanceCut Chain Reel

NOT ALL SIZES AND PRODUCTS ARE SHOWN, VISIT OUR WEBSITE OR CONTACT US FOR MORE INFORMATION.

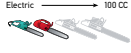
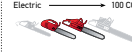
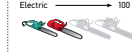
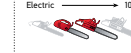
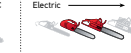
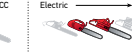
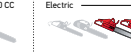

# Bar and Chain Families

IDENTIFY THE RIGHT OREGON® GUIDE BAR & CHAIN FOR YOU.

								
	<p><b>Single Rivet</b> Formerly Double Guard™</p> <p><b>Guide Bar</b> Occasional use with a single-rivet. Smaller radius nose reduces kickback.</p>	<p><b>AdvanceCut™</b> Formerly Pro-Am®</p> <p><b>Guide Bar</b> For experienced users. Multi-rivet nose, light-weight, and maneuverable.</p> <p><b>Chain</b> Durability and performance you can count on, features to reduce kickback.</p>	<p><b>SpeedCut™ Nano</b></p> <p><b>Cutting System</b> Specifically engineered to optimize performance on battery-powered and compact light-weight chainsaws.</p> <p><small>Must be used together with the corresponding guide bar and sprocket and is not compatible with other existing cutting systems.</small></p>	<p><b>SpeedCut™</b> </p> <p>Formerly Pro-Lite®</p> <p><b>Guide Bar</b> High-volume cutting. Durable and efficient narrow kerf design.</p> <p><b>Chain</b> Faster, sharper, and easier to maintain; requires less power for faster cuts.</p>	<p><b>ControlCut™</b> Formerly Pro-Lite®</p> <p><b>Guide Bar</b> Smooth and control cuts. Smaller radius nose reduces kickback.</p> <p><b>Chain</b> Smooth cutting with features to reduce kickback.</p>	<p><b>VersaCut™</b> Formerly Pro-Lite®</p> <p><b>Guide Bar</b> Versatile and durable.</p> <p><b>Chain</b> Multipurpose use, stays sharp longer and is easier to file.</p>	<p><b>PowerCut™</b> Formerly Power Match®</p> <p><b>Guide Bar</b> Replaceable sprocket nose and chrome-moly body promotes longevity.</p> <p><b>Chain</b> Maximum speed with precision cutting for high performance saws.</p>	<p><b>DuraCut™</b> Formerly Armor Tip</p> <p><b>Guide Bar</b> Stellite nose and chrome-moly body promotes ultra high-wear resistance.</p> <p><b>Chain</b> Maximum sharpness and durability for abrasive conditions.</p>
	Electric → 100 CC 	Electric → 100 CC 	Electric → 100 CC 	Electric → 100 CC 	Electric → 100 CC 	Electric → 100 CC 	Electric → 100 CC 	Electric → 100 CC 
<b>1/4"</b>	ControlCut 25P 25AP							
<b>.325"</b> Low Profile			SpeedCut Nano 80TXL					
<b>3/8"</b> Low Profile	<p><b>AdvanceCut</b> 90PX 91PX 91PXL</p> <p><b>VersaCut</b> 91VXL</p> <p><b>DuraCut</b> M91VXL</p> <p><b>PowerSharp</b> 91PS</p>	<p><b>AdvanceCut</b> 91PX 91PXL</p> <p><b>VersaCut</b> 91VXL</p> <p><b>DuraCut</b> M91VXL</p>						
<b>.325"</b>		<p><b>PowerCut</b> 20LGX 21LGX 22LGX 20LPX 21LPX 22LPX</p> <p><b>ControlCut</b> 20BPX 21BPX 22BPX</p> <p><b>DuraCut</b> M20BPX M21BPX M22BPX</p>	<p><b>SpeedCut</b> 95TXL </p>	<p><b>PowerCut</b> 20LGX 21LGX 22LGX 20LPX 21LPX 22LPX</p> <p><b>ControlCut</b> 20BPX 21BPX 22BPX</p> <p><b>DuraCut</b> M20BPX M21BPX M22BPX</p>	<p><b>PowerCut</b> 20LGX 21LGX 22LGX 20LPX 21LPX 22LPX</p> <p><b>ControlCut</b> 20BPX 21BPX 22BPX</p> <p><b>DuraCut</b> M20BPX M21BPX M22BPX</p>	<p><b>PowerCut</b> 20LGX 21LGX 22LGX 20LPX 21LPX 22LPX</p> <p><b>ControlCut</b> 20BPX 21BPX 22BPX</p> <p><b>DuraCut</b> M20BPX M21BPX M22BPX</p>	<p><b>PowerCut</b> 20LGX 21LGX 22LGX 20LPX 21LPX 22LPX</p> <p><b>ControlCut</b> 20BPX 21BPX 22BPX</p> <p><b>DuraCut</b> M20BPX M21BPX M22BPX</p>	<p><b>PowerCut</b> 20LGX 21LGX 22LGX 20LPX 21LPX 22LPX</p> <p><b>ControlCut</b> 20BPX 21BPX 22BPX</p> <p><b>DuraCut</b> M20BPX M21BPX M22BPX</p>
<b>3/8"</b>		<p><b>PowerCut</b> 72EXL 73EXL 75EXL 72LGX 73LGX 75LGX 72JGX 73JGX 75JGX 72LPX 73LPX 75LPX 72CL 73CL 75CL 72CK 73CK 75CK 72CJ 75CJ 72JPX</p> <p><b>VersaCut</b> 72DPX 73DPX 75DPX 72APX</p> <p><b>DuraCut</b> M72DPX M73DPX M75DPX</p> <p><b>AdvanceCut</b> 72V 73V 75V</p>			<p><b>PowerCut</b> 72EXL 73EXL 75EXL 72LGX 73LGX 75LGX 72JGX 73JGX 75JGX 72LPX 73LPX 75LPX 72CL 73CL 75CL 72CK 73CK 75CK 72CJ 75CJ 72JPX</p> <p><b>VersaCut</b> 72DPX 73DPX 75DPX 72APX</p> <p><b>DuraCut</b> M72DPX M73DPX M75DPX</p> <p><b>AdvanceCut</b> 72V 73V 75V</p>	<p><b>PowerCut</b> 72EXL 73EXL 75EXL 72LGX 73LGX 75LGX 72JGX 73JGX 75JGX 72LPX 73LPX 75LPX 72CL 73CL 75CL 72CK 73CK 75CK 72CJ 75CJ 72JPX</p> <p><b>VersaCut</b> 72DPX 73DPX 75DPX 72APX</p> <p><b>DuraCut</b> M72DPX M73DPX M75DPX</p> <p><b>AdvanceCut</b> 72V 73V 75V</p>	<p><b>PowerCut</b> 72EXL 73EXL 75EXL 72LGX 73LGX 75LGX 72JGX 73JGX 75JGX 72LPX 73LPX 75LPX 72CL 73CL 75CL 72CK 73CK 75CK 72CJ 75CJ 72JPX</p> <p><b>VersaCut</b> 72DPX 73DPX 75DPX 72APX</p> <p><b>DuraCut</b> M72DPX M73DPX M75DPX</p> <p><b>AdvanceCut</b> 72V 73V 75V</p>	<p><b>PowerCut</b> 72EXL 73EXL 75EXL 72LGX 73LGX 75LGX 72JGX 73JGX 75JGX 72LPX 73LPX 75LPX 72CL 73CL 75CL 72CK 73CK 75CK 72CJ 75CJ 72JPX</p> <p><b>VersaCut</b> 72DPX 73DPX 75DPX 72APX</p> <p><b>DuraCut</b> M72DPX M73DPX M75DPX</p> <p><b>AdvanceCut</b> 72V 73V 75V</p>
<b>.404"</b>						<p><b>PowerCut</b> 58L 59L 59J 68LX 68LX 68JX 68JX 68CL 68CL 68CJ 68CJ</p> <p><b>VersaCut</b> 27X 27AX</p> <p><b>RipCut</b> 27R 27RX</p>	<p><b>PowerCut</b> 58L 59L 59J 68LX 68LX 68JX 68JX 68CL 68CL 68CJ 68CJ</p> <p><b>VersaCut</b> 27X 27AX</p> <p><b>RipCut</b> 27R 27RX</p>	

# bars

## Oregon SpeedCut .325" Guide Bars



Pairs with **SpeedCut** chain to create the next generation narrow-kerf system on saws up to 55 cc displacement. Designed to deliver faster cutting and reduced weight compared to standard cutting systems.

Available Mounts: A074, D025, K095



SKU	TAIL	GB CODE	LENGTH	PRODUCT
130TXLBK095	K095	TXLB	13"	SpeedCut Guide Bars
150TXLBK095	K095	TXLB	15"	SpeedCut Guide Bars
150TXLGK095	K095	TXLG	15"	SpeedCut Guide Bars
160TXLBA074	A074	TXLB	16"	SpeedCut Guide Bars
160TXLBK095	K095	TXLB	16"	SpeedCut Guide Bars
160TXLGD025	D025	TXLG	16"	SpeedCut Guide Bars
160TXLGK095	K095	TXLG	16"	SpeedCut Guide Bars
180TXLBA074	A074	TXLB	18"	SpeedCut Guide Bars
180TXLBK095	K095	TXLB	18"	SpeedCut Guide Bars
180TXLGD025	D025	TXLG	18"	SpeedCut Guide Bars
180TXLGK095	K095	TXLG	18"	SpeedCut Guide Bars
180TXLGK216	K216	TXLG	18"	SpeedCut Guide Bars
200TXLBK095	K095	TXLB	20"	SpeedCut Guide Bars

## Oregon ControlCut .325" Guide Bars



Standard-kerf bars that feature a small radius nose for reduced kickback

Available Mounts: A074, D025, K041, K095



SKU	TAIL	GB CODE	LENGTH	PRODUCT
138PXLBK095	K095	PXLB	13"	ControlCut Guide Bars
158PXLBK095	K095	PXLB	15"	ControlCut Guide Bars
160PXLBA074	A074	PXLB	16"	ControlCut Guide Bars
163PXLBA074	A074	PXLB	16"	ControlCut Guide Bars
168PXLBK095	K095	PXLB	16"	ControlCut Guide Bars
180PXLBA074	A074	PXLB	18"	ControlCut Guide Bars
183PXLBA074	A074	PXLB	18"	ControlCut Guide Bars
188PXLBK095	K095	PXLB	18"	ControlCut Guide Bars

NOT ALL SIZES AND PRODUCTS ARE SHOWN, VISIT OUR WEBSITE OR CONTACT US FOR MORE INFORMATION.

## Oregon VersaCut .325" Guide Bars



Standard-kerf bars that feature a large radius nose and are designed to perform in a wide range of professional applications.

Available Mounts: D009, D024, D025, D176, K041, K095, K216, Z095



SKU	TAIL	GB CODE	LENGTH	PRODUCT
158VXLGK095	K095	VXLG	15"	VersaCut Guide Bars
160VXLGD025	D025	VXLG	16"	VersaCut Guide Bars
160VXLGK041	K041	VXLG	16"	VersaCut Guide Bars
160VXLGK095	K095	VXLG	16"	VersaCut Guide Bars
160VXLGK216	K216	VXLG	16"	VersaCut Guide Bars
160VXLHD009	D009	VXLH	16"	VersaCut Guide Bars
160VXLHD025	D025	VXLH	16"	VersaCut Guide Bars
160VXLHD176	K095	VXLH	16"	VersaCut Guide Bars
160VXLHK095	K095	VXLH	16"	VersaCut Guide Bars
163VXLGD025	D025	VXLG	16"	VersaCut Guide Bars
163VXLHD025	D025	VXLH	16"	VersaCut Guide Bars
168VXLGK041	K041	VXLG	16"	VersaCut Guide Bars
180VXLGD009	D009	VXLG	18"	VersaCut Guide Bars
180VXLGD025	D025	VXLG	18"	VersaCut Guide Bars
180VXLGK041	K041	VXLG	18"	VersaCut Guide Bars
180VXLGK095	K095	VXLG	18"	VersaCut Guide Bars
180VXLGK216	K216	VXLG	18"	VersaCut Guide Bars
180VXLHD009	D009	VXLH	18"	VersaCut Guide Bars
180VXLHD025	D025	VXLH	18"	VersaCut Guide Bars
180VXLHD176	D176	VXLH	18"	VersaCut Guide Bars
180VXLHK095	K095	VXLH	18"	VersaCut Guide Bars
183VXLGD025	D025	VXLG	18"	VersaCut Guide Bars
183VXLHD025	D025	VXLH	18"	VersaCut Guide Bars
188VXLGK041	K041	VXLG	18"	VersaCut Guide Bars
188VXLGK095	K095	VXLG	18"	VersaCut Guide Bars
200VXLGK041	K041	VXLG	20"	VersaCut Guide Bars
200VXLGK095	K095	VXLG	20"	VersaCut Guide Bars
200VXLGK216	K216	VXLG	20"	VersaCut Guide Bars
200VXLHD009	D009	VXLH	20"	VersaCut Guide Bars
200VXLHD025	D025	VXLH	20"	VersaCut Guide Bars
200VXLHD176	D176	VXLH	20"	VersaCut Guide Bars
200VXLHK095	K095	VXLH	20"	VersaCut Guide Bars
203VXLGD025	D025	VXLG	20"	VersaCut Guide Bars
203VXLHD025	D025	VXLH	20"	VersaCut Guide Bars
240VXLGD009	D009	VXLG	24"	VersaCut Guide Bars
240VXLHD009	D009	VXLH	24"	VersaCut Guide Bars
240VXLHD025	D025	VXLH	24"	VersaCut Guide Bars
243VXLHD025	D025	VXLH	24"	VersaCut Guide Bars
248VXLHD009	D009	VXLH	24"	VersaCut Guide Bars



## Oregon DuraCut .325", 3/8", .404" Guide Bars

OREGON

Longer life, ultra high-wear resistant stellite alloy.

Much stronger bar due to super tough, chrome-moly steel, and tough rails with excellent resistance to wear and chipping

Available Mounts: D009, D025, D176, K095, Z095

SKU	TAIL	GB CODE	LENGTH	PRODUCT
160ATMD009	D009	ATM	16"	DuraCut Guide Bars
160ATMD025	D025	ATM	16"	DuraCut Guide Bars
160ATMK095	K095	ATM	16"	DuraCut Guide Bars
163ATMD025	D025	ATM	16"	DuraCut Guide Bars
180ATMD025	D025	ATM	18"	DuraCut Guide Bars
180ATMK095	K095	ATM	18"	DuraCut Guide Bars
180ATMZ095	Z095	ATM	18"	DuraCut Guide Bars
183ATMD025	D025	ATM	18"	DuraCut Guide Bars
188ATMD009	D009	ATM	18"	DuraCut Guide Bars
188ATMK095	K095	ATM	18"	DuraCut Guide Bars
200ATMD009	D009	ATM	20"	DuraCut Guide Bars
200ATMD025	D025	ATM	20"	DuraCut Guide Bars



SKU	TAIL	GB CODE	LENGTH	PRODUCT
200ATMD176	D176	ATM	20"	DuraCut Guide Bars
200ATMK095	K095	ATM	20"	DuraCut Guide Bars
200ATMZ095	Z095	ATM	20"	DuraCut Guide Bars
203ATMD009	D009	ATM	20"	DuraCut Guide Bars
203ATMD025	D025	ATM	20"	DuraCut Guide Bars
208ATMD009	D009	ATM	20"	DuraCut Guide Bars
240ATMD009	D009	ATM	24"	DuraCut Guide Bars
240ATMD025	D025	ATM	24"	DuraCut Guide Bars
240ATMD176	D176	ATM	24"	DuraCut Guide Bars
243ATMD025	D025	ATM	24"	DuraCut Guide Bars
248ATMD009	D009	ATM	24"	DuraCut Guide Bars
288ATMD009	D009	ATM	28"	DuraCut Guide Bars

## Oregon PowerCut 3/8" Guide Bars

OREGON

Replaceable bar nose eliminates need to purchase a new bar.

Nose fastens with a single rivet, and is secured by wide, strong, overlapping ears.

Much stronger bar with super tough chrome-moly steel. And tough rails with excellent resistance to wearing and chipping.

Available Mounts: D009, D024, D025, D033, D176, D196, E031, K041, K095, Z095

SKU	TAIL	GB CODE	LENGTH	PRODUCT
138RNDD009	D009	RND	13"	PowerCut Guide Bars
160RNBK041	K041	RNB	16"	PowerCut Guide Bars
160RNDK095	K095	RND	16"	PowerCut Guide Bars
163RNB025	D025	RNB	16"	PowerCut Guide Bars
163RNDD025	D025	RND	16"	PowerCut Guide Bars
168RNBK095	K095	RNB	16"	PowerCut Guide Bars
180RNBK041	K041	RNB	18"	PowerCut Guide Bars
180RNDD009	D009	RND	18"	PowerCut Guide Bars
180RNDD025	D025	RND	18"	PowerCut Guide Bars
180RNDD176	D176	RND	18"	PowerCut Guide Bars
180RNDK095	K095	RND	18"	PowerCut Guide Bars
183RNB025	D025	RNB	18"	PowerCut Guide Bars
183RNDD025	D025	RND	18"	PowerCut Guide Bars
188RNBK095	K095	RNB	18"	PowerCut Guide Bars
188RNDD009	D009	RND	18"	PowerCut Guide Bars
200RNBK095	K095	RNB	20"	PowerCut Guide Bars
200RNDD025	D025	RND	20"	PowerCut Guide Bars
200RNDD176	D176	RND	20"	PowerCut Guide Bars
200RNDD196	D196	RND	20"	PowerCut Guide Bars
200RNDK095	K095	RND	20"	PowerCut Guide Bars
203RNDD009	D009	RND	20"	PowerCut Guide Bars
203RNDD025	D025	RND	20"	PowerCut Guide Bars
208RNBK095	K095	RNB	20"	PowerCut Guide Bars
208RNDD009	D009	RND	20"	PowerCut Guide Bars
213RNFE031	E031	RNF	21"	PowerCut Guide Bars
228RNDD009	D009	RND	22"	PowerCut Guide Bars
240RNDD009	D009	RND	24"	PowerCut Guide Bars
240RNDD025	D025	RND	24"	PowerCut Guide Bars



SKU	TAIL	GB CODE	LENGTH	PRODUCT
240RNDD176	D176	RND	24"	PowerCut Guide Bars
240RNDD196	D196	RND	24"	PowerCut Guide Bars
240RNDK095	K095	RND	24"	PowerCut Guide Bars
243RNDD009	D009	RND	24"	PowerCut Guide Bars
243RNDD025	D025	RND	24"	PowerCut Guide Bars
253RNFE031	E031	RNF	25"	PowerCut Guide Bars
268RNDD009	D009	RND	26"	PowerCut Guide Bars
280RNDD009	D009	RND	28"	PowerCut Guide Bars
280RNDD025	D025	RND	28"	PowerCut Guide Bars
280RNDD176	D176	RND	28"	PowerCut Guide Bars
280RNDK095	K095	RND	28"	PowerCut Guide Bars
283RNDD009	D009	RND	28"	PowerCut Guide Bars
300RNDD009	D009	RND	30"	PowerCut Guide Bars
300RNDD025	D025	RND	30"	PowerCut Guide Bars
303RNDD025	D025	RND	30"	PowerCut Guide Bars
308RNDD009	D009	RND	30"	PowerCut Guide Bars
320RNDD009	D009	RND	32"	PowerCut Guide Bars
320RNDD025	D025	RND	32"	PowerCut Guide Bars
323RNDD009	D009	RND	32"	PowerCut Guide Bars
323RNDD025	D025	RND	32"	PowerCut Guide Bars
328RNDD009	D009	RND	32"	PowerCut Guide Bars
343RNDD025	D025	RND	34"	PowerCut Guide Bars
363RNDD009	D009	RND	36"	PowerCut Guide Bars
363RNDD025	D025	RND	36"	PowerCut Guide Bars
363RNFD009	D009	RNF	36"	PowerCut Guide Bars
368RNDD009	D009	RND	36"	PowerCut Guide Bars
423RNDD009	D009	RND	42"	PowerCut Guide Bars
423RNFD009	D009	RNF	42"	PowerCut Guide Bars

## Oregon AdvanceCut 3/8" Low Profile Guide Bars



Slim symmetrical contour, is light-weight, easy to maneuver, and is reversible for longer life.

Multi-Rivet nose for long-lasting durability

Available Mounts: A041, A074, A095, A318, D009, D025, D096, D176, K041, K095, T041



SKU	TAIL	GB CODE	LENGTH	PRODUCT
120SXEA041	A041	SXE	12"	AdvanceCut Guide Bars
120SXEA074	A074	SXE	12"	AdvanceCut Guide Bars
120SXEA095	A095	SXE	12"	AdvanceCut Guide Bars
130MLBK041	K041	MLB	13"	AdvanceCut Guide Bars
130MLBK095	K095	MLB	13"	AdvanceCut Guide Bars
140SXEA041	A041	SXE	14"	AdvanceCut Guide Bars
140SXEA074	A074	SXE	14"	AdvanceCut Guide Bars
140SXEA095	A095	SXE	14"	AdvanceCut Guide Bars
140SXEA318	A318	SXE	14"	AdvanceCut Guide Bars
150MLBK041	K041	MLB	15"	AdvanceCut Guide Bars
160GDBK041	K041	GDB	16"	AdvanceCut Guide Bars
160GDD096	D096	GDD	16"	AdvanceCut Guide Bars
160GDD176	D176	GDD	16"	AdvanceCut Guide Bars
160MLBK041	K041	MLB	16"	AdvanceCut Guide Bars
160MLBK095	K095	MLB	16"	AdvanceCut Guide Bars
160PXBK041	K041	PXB	16"	AdvanceCut Guide Bars
160PXBK095	K095	PXB	16"	AdvanceCut Guide Bars
160PXB041	T041	PXB	16"	AdvanceCut Guide Bars
160PXD176	D176	PXD	16"	AdvanceCut Guide Bars
160PXD095	K095	PXD	16"	AdvanceCut Guide Bars
160SFHD025	D025	SFH	16"	AdvanceCut Guide Bars
160SFHK095	K095	SFH	16"	AdvanceCut Guide Bars
160SXEA041	A041	SXE	16"	AdvanceCut Guide Bars
160SXEA074	A074	SXE	16"	AdvanceCut Guide Bars
160SXEA095	A095	SXE	16"	AdvanceCut Guide Bars
168PXBK095	K095	PXB	16"	AdvanceCut Guide Bars
168SFHD009	D009	SFH	16"	AdvanceCut Guide Bars
180GDBK041	K041	GDB	18"	AdvanceCut Guide Bars
180GDD096	D096	GDD	18"	AdvanceCut Guide Bars
180GDD176	D176	GDD	18"	AdvanceCut Guide Bars
180MLBK041	K041	MLB	18"	AdvanceCut Guide Bars

SKU	TAIL	GB CODE	LENGTH	PRODUCT
180MLBK095	K095	MLB	18"	AdvanceCut Guide Bars
180PXB176	D176	PXB	18"	AdvanceCut Guide Bars
180PXBK041	K041	PXB	18"	AdvanceCut Guide Bars
180PXBK095	K095	PXB	18"	AdvanceCut Guide Bars
180PXB041	T041	PXB	18"	AdvanceCut Guide Bars
180PXDD176	D176	PXD	18"	AdvanceCut Guide Bars
180SFHK095	K095	FHK	18"	AdvanceCut Guide Bars
183PXB074	A074	PXB	18"	AdvanceCut Guide Bars
183SFHD025	D025	FHD	18"	AdvanceCut Guide Bars
188PXBK095	K095	PXB	18"	AdvanceCut Guide Bars
188SFHK095	K095	FHK	18"	AdvanceCut Guide Bars
200GDBK041	K041	GDB	20"	AdvanceCut Guide Bars
200GDD096	D096	GDD	20"	AdvanceCut Guide Bars
200GDD176	D176	GDD	20"	AdvanceCut Guide Bars
200PXBK041	K041	PXB	20"	AdvanceCut Guide Bars
200PXBK095	K095	PXB	20"	AdvanceCut Guide Bars
200PXB041	T041	PXB	20"	AdvanceCut Guide Bars
200PXDD176	D176	PXD	20"	AdvanceCut Guide Bars
200PXD041	K041	PXD	20"	AdvanceCut Guide Bars
200SFHD009	D009	FHD	20"	AdvanceCut Guide Bars
200SFHD025	D025	FHD	20"	AdvanceCut Guide Bars
200SFHK095	K095	FHK	20"	AdvanceCut Guide Bars
203SFHD025	D025	FHD	20"	AdvanceCut Guide Bars
208PXBK095	K095	PXB	20"	AdvanceCut Guide Bars
208SFHD009	D009	SFH	20"	AdvanceCut Guide Bars
208SFHK095	K095	SFH	20"	AdvanceCut Guide Bars
240SFHD009	D009	SFH	24"	AdvanceCut Guide Bars
240SFHD025	D025	SFH	24"	AdvanceCut Guide Bars
243SFHD025	D025	SFH	24"	AdvanceCut Guide Bars
248SFHD009	D009	SFH	24"	AdvanceCut Guide Bars

## How the Oregon Guide Bar Part Numbering System Works

Oregon guide bar part numbers are printed on the bar package and etched on the bar body. Here's what each digit means:

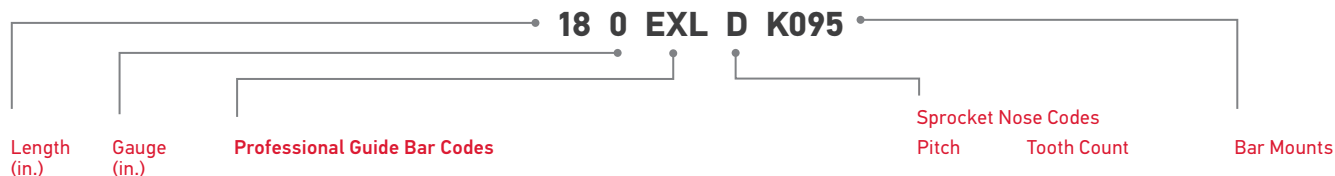



## Oregon Single Rivet 3/8" Low Profile Guide Bars

Slim symmetrical contour is light in weight, maneuverable, and reversible

Small-radius nose helps reduce kickback

Available Mounts: A041, A061, A074, A095, A108, A218, A318, Z041, Z095



SKU	TAIL	GB CODE	LENGTH	PRODUCT
080SDEA041	A041	SDE	8"	Single Rivet Guide Bars
084MLEA041	A041	MLE	8"	Single Rivet Guide Bars
100SDEA041	A041	SDE	10"	Single Rivet Guide Bars
100SDEA218	A218	SDE	10"	Single Rivet Guide Bars
100SDET218	T218	SDE	10"	Single Rivet Guide Bars
104MLEA218	A218	MLE	10"	Single Rivet Guide Bars
104MLEA318	A318	MLE	10"	Single Rivet Guide Bars
120DGEA041	A041	DGE	12"	Single Rivet Guide Bars
120DGEA061	A061	DGE	12"	Single Rivet Guide Bars
120DGET041	T041	DGE	12"	Single Rivet Guide Bars
120DGET061	T061	DGE	12"	Single Rivet Guide Bars
120SDEA041	A041	SDE	12"	Single Rivet Guide Bars
120SDEA064	A064	SDE	12"	Single Rivet Guide Bars
120SDEA074	A074	SDE	12"	Single Rivet Guide Bars
120SDEA089	A089	SDE	12"	Single Rivet Guide Bars
120SDEA095	A095	SDE	12"	Single Rivet Guide Bars
120SDEA218	A218	SDE	12"	Single Rivet Guide Bars
120SDEA318	A318	SDE	12"	Single Rivet Guide Bars
120SDET041	T041	SDE	12"	Single Rivet Guide Bars
120SDET074	T074	SDE	12"	Single Rivet Guide Bars
120SDET218	T218	SDE	12"	Single Rivet Guide Bars
124MLEA041	A041	MLE	12"	Single Rivet Guide Bars
124MLEA074	A074	MLE	12"	Single Rivet Guide Bars
124MLEA218	A218	MLE	12"	Single Rivet Guide Bars
140DGEA041	A041	DGE	14"	Single Rivet Guide Bars
140DGEA061	A061	DGE	14"	Single Rivet Guide Bars
140DGET041	T041	DGE	14"	Single Rivet Guide Bars
140SDEA041	A041	SDE	14"	Single Rivet Guide Bars
140SDEA064	A064	SDE	14"	Single Rivet Guide Bars
140SDEA074	A074	SDE	14"	Single Rivet Guide Bars
140SDEA089	A089	SDE	14"	Single Rivet Guide Bars
140SDEA095	A095	SDE	14"	Single Rivet Guide Bars
140SDEA218	A218	SDE	14"	Single Rivet Guide Bars
140SDEA318	A318	SDE	14"	Single Rivet Guide Bars
140SDET041	T041	SDE	14"	Single Rivet Guide Bars
140SDET074	T074	SDE	14"	Single Rivet Guide Bars
140SDET095	T095	SDE	14"	Single Rivet Guide Bars
140SDET318	A318	SDE	14"	Single Rivet Guide Bars
144MLEA041	A041	MLE	14"	Single Rivet Guide Bars
144MLEA074	A074	MLE	14"	Single Rivet Guide Bars

### PROFESSIONAL GUIDE BAR CODES

- SpeedCut Nano (TXL)
- SpeedCut (TXL)
- VersaCut (VXL)
- ControlCut (PXL)
- PowerCut (EXL, RN, PM, RW)
- DuraCut (DXL, AT)

### OCCASIONAL USER BAR CODES

- AdvanceCut (SX, PX, GD, ML, SF)
- Single Rivet (SD, DG, ML)

Visit [oregonproducts.com](http://oregonproducts.com) for additional information.

SKU	TAIL	GB CODE	LENGTH	PRODUCT
160DGEA041	A041	DGE	16"	Single Rivet Guide Bars
160DGEA061	A061	DGE	16"	Single Rivet Guide Bars
160DGET041	T041	DGE	16"	Single Rivet Guide Bars
160DGET061	T061	DGE	16"	Single Rivet Guide Bars
160SDEA041	A041	SDE	16"	Single Rivet Guide Bars
160SDEA074	A074	SDE	16"	Single Rivet Guide Bars
160SDEA089	A089	SDE	16"	Single Rivet Guide Bars
160SDEA095	A095	SDE	16"	Single Rivet Guide Bars
160SDEA318	A318	SDE	16"	Single Rivet Guide Bars
160SDET041	T041	SDE	16"	Single Rivet Guide Bars
160SDET074	T074	SDE	16"	Single Rivet Guide Bars
160SDET095	T095	SDE	16"	Single Rivet Guide Bars
160SDET218	T218	SDE	16"	Single Rivet Guide Bars
160SDET318	A318	SDE	16"	Single Rivet Guide Bars
164MLEA041	A041	MLE	16"	Single Rivet Guide Bars
164MLEA074	A074	MLE	16"	Single Rivet Guide Bars
180DGEA041	A041	DGE	18"	Single Rivet Guide Bars
180DGEA061	A061	DGE	18"	Single Rivet Guide Bars
180SDEA041	A041	SDE	18"	Single Rivet Guide Bars
180SDEA095	A095	SDE	18"	Single Rivet Guide Bars
180SDEA318	A318	SDE	18"	Single Rivet Guide Bars
180SDET041	T041	SDE	18"	Single Rivet Guide Bars



Courtesy of Oregon



## Oregon SpeedCut Nano™ .325" Low Profile Guide Bars



The .325" Low Profile cutting system specifically engineered to optimize performance on battery-powered and compact light-weight gas chainsaws (20-38 cc). When the job demands accurate cuts with unmatched speed and endurance to run all-day without downtime, professionals choose SpeedCut Nano.

SpeedCut Nano guide bars must be used together with the corresponding 80TXL saw chain and sprocket and are not compatible with other existing cutting systems.



SKU	LENGTH	PRODUCT
104TXLNA074	10"	SpeedCut Nano Guide Bars
124TXLNA074	12"	SpeedCut Nano Guide Bars
144TXLNA074	14"	SpeedCut Nano Guide Bars
164TXLNA074	16"	SpeedCut Nano Guide Bars

Rarely do I find that out of the box modifications make a big impact on saw performance. Not so with this bar/chain combo from **Oregon**.

Through my career I have run a 14" bar on my top handle saws because I was unhappy with the power to performance ratio of the 16" bar because I always found the power lacking and the chain speed slow.

With the **Oregon SpeedCut Nano 16" bar/chain combo** I found a reduction in vibration and a faster cut. The saw handles the additional length with no noticeable reduction in power which is incredible. Additionally, I found the performance (sharpness) out of the box to be superior as well as the durability of the chain (more time between sharpening). Running a 16" bar on my 201 allows me to run a small saw longer, reducing fatigue by keeping the big saws in the tool box. My whole team was impressed. I am very happy with the product and performance and am excited to see how it performs on our electric and power pole saws! Thank you, Melissa for turning me on to it!"

— Paul Sierau, Certified Arborist, John W. Field Tree Service, MA



Kayla Ender



OREGON®

# BIG POWER for SMALL SAWS

## SpeedCut™ Nano Cutting System

80 TXL Saw Chain, .325" Low Profile™ Guide Bar, Sprocket

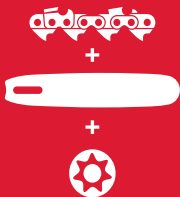

Whether you're pruning or topping, your work demands you have the right tools for the job.

Introducing Oregon SpeedCut™ Nano, an all-new .325" Low Profile™ cutting system *specifically engineered* to optimize performance on *battery-powered and compact light-weight gas chainsaws* (20–38 cc).

[OregonProducts.com/SpeedMax](http://OregonProducts.com/SpeedMax)

# accessories

## Oregon Assembled File Guides



### SPECS + FEATURES

- File guide grips file securely and keeps file at the correct depth for a more effective chain
- Lines on the file guides frame make it easy to align the file consistently and correctly
- Wood handle provides comfort during filing

SKU	DIAMETER	PRODUCT
37534	5/32"	Assembled File Guide
31690	3/16"	Assembled File Guide
31686	7/32"	Assembled File Guide
31692	4.5 mm	Assembled File Guide



## PFERD CS-X Saw Chain Sharpener



Sharpening with CHAIN SHARP CS-X guarantees longer durability and use of the saw chain.

### SPECS + FEATURES

- Saw Chain Sharpeners consist of 1 sharpening device, one depth gauge file and two saw chain files

SKU	DIAMETER	PRODUCT
17301	3/16"	3/16" Diameter 0.325 Pitch 0.025 Depth Gauge
17304	7/32"	7/32" Diameter 0.404 Pitch 0.030 Depth Gauge



## Oregon Flat Files



Made from the finest steel, these flat files are used in combination with an Oregon Depth Gauge tool to maintain saw chain depth gauge settings.

### SPECS + FEATURES

- Specially heat-treated for maximum stay-sharp
- Resists clogging
- Depth Gauge Filing Kit (40466) - Includes:
  - One flat file and one depth gauge tool, can be used with or without a handle
  - 0.025" drop-center depth gauge tool makes accurate, consistent depth gauge setting easy.

SKU	PRODUCT
12211	Dozen - 6" Flat Files
40466	Depth Gauge Filing Kit
30870-B	Display Box, File Handle 100Pcs



## Oregon Round Saw Files



The double-cut file from Oregon is an outstanding file for sharpening saw chain.

### SPECS + FEATURES

- Superior performance
- Finest steel material
- State-of-the-art production and finishing processes
- Smooth filing action
- Long stay-sharp
- Resists clogging

SKU	DIAMETER	APPLICATION	PRODUCT
70502	7/32" (5.5 mm)	70 Series & .404"	Dozen - Round Saw Files
70503	3/16" (4.8 mm)	20-22,95 Series	Dozen - Round Saw Files
70504	5/32" (4.0 mm)	90 & 91 Series	Dozen - Round Saw Files
70505	13/64" (5 mm)	33-35 Series, 90S	Dozen - Round Saw Files
70511	4.5 mm	33-35 Series, 90S	Dozen - Round Saw Files
90410	5/16"	3/4", 11BC, 11H	Half Dozen - Round Saw Files





## Oregon Forestry Wedges



Durable, Light-weight, Serrations hold wedge in the tree securely

SKU	SIZE	PRODUCT
23562	5 1/2"	Forestry Wedges
23561	8"	Forestry Wedges
23560	10"	Forestry Wedges
26782	12"	Forestry Wedges

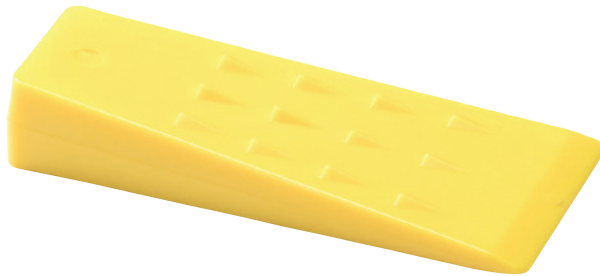

## K & H Felling Wedges

Since 1962 K & H felling wedges are also known as "red head" wedges because of their distinctive head color.

### SPECS + FEATURES

- Made from very hard high impact ABS plastic.
- Light textured surface to keep them from slipping
- Easy to drive
- Great lifting power

SKU	SIZE	PRODUCT
5 1/2 PL	5 1/2"	Felling Wedges
7 1/2 PL	7 1/2"	Felling Wedges
10TT	10"	Felling Wedges, Tapered

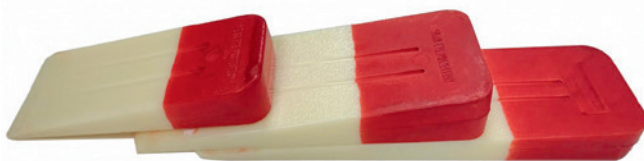

## Spencer Tape

Available in a number of lengths/scales designed to measure the diameter of trees.

### SPECS + FEATURES

- Designed for heavy-duty use in the logging industry
- Rugged aircraft aluminum case
- Automatic rewind
- Open reel design with gear drive

SKU	SIZE	PRODUCT
45115	50'	Auto-Rewind Logging Tape
45119	50'	Refill Auto-Rewind Logging Tape
45135	50'	Tape w/ 19" Dymax Leader
69829		Release Nail, Spencer Tape

## OTT Accu-Stick Pro



OTT Accu-Stick makes cutting firewood to length quick and easy. Telescoping adjustable length tube from 14 - 26 inches' with 1/4 inch increments.

### SPECS + FEATURES

- OTT Accu-Stick is easy to use, magnetically sticks to the side of any steel chain bar
- Can also can be placed on the side of the saw dogs if your saw has them
- No need to keep the tool on saw, the tool can be easily removed and is very light weight at 90 g you barely even know it is on your saw.
- Tool collapses down to approximately 14"

SKU	SIZE	PRODUCT
ACCU-STICK PRO	14-26"	Accu Stick Pro



## OTT 13-19 mm Double Socket Chainsaw Bar Tool



The OTT Ultra-Thin Chain Bar Tool is engineered, designed and manufactured to precise tolerances. Made of high quality materials such as Aluminum, Stainless Steel, and Titanium. The body of the tool is precision machined out of solid billet aluminum. The retractable screwdriver is made of all Stainless Steel. The pivoting socket screw is made of Titanium, which makes for an extremely durable, light weight, all in one, long lasting tool.

### SPECS + FEATURES

- Retractable screwdriver within the thickness of the tool body handle
- Overall length: 5"
- Precision forged pivoting magnetic socket, which is made in the USA.
- Pivoting socket allows the user to magnetically attach the tool to the chain bar nut and pivot 180 degrees
- Find optimal position and leverage needed to tighten or loosen the chain bar.
- User does not need to use two hands to tighten or loosen the chain bar nuts

SKU	ATTRIBUTE	PRODUCT
Magnetic 13-19mm	Magnet	Double Socket Chainsaw Bar Tool
Non-Magn 13-19mm	Non-Magnet	Double Socket Chainsaw Bar Tool



## FORESTRY / ACCESSORIES

### Oregon Srenches

A combination screwdriver and wrench to make chainsaw guidebar removal, chain tensioning, and other chain saw maintenance easier

#### SPECS + FEATURES

- All metal design combines a wrench and screwdriver to make an all-in-one tool
- Ideal for replacing chainsaw bars and chain tensioning
- Long body provides more leverage while working

SKU	S1 & S2	PRODUCT
57-005	13 x 19	Srenches
57-017	13 x 19	Srenches
57-016	13 x 19	Srenches
57-003	19 x 10	Srenches
57-002	16 x 13	Srenches
57-008	19 x 17	Srenches
57-019	19	Srenches
57-006	19 x 14	Srenches
57-010	21 x 17	Srenches
57-014	15 x 19	Srenches
57-001	16 x 11	Srenches

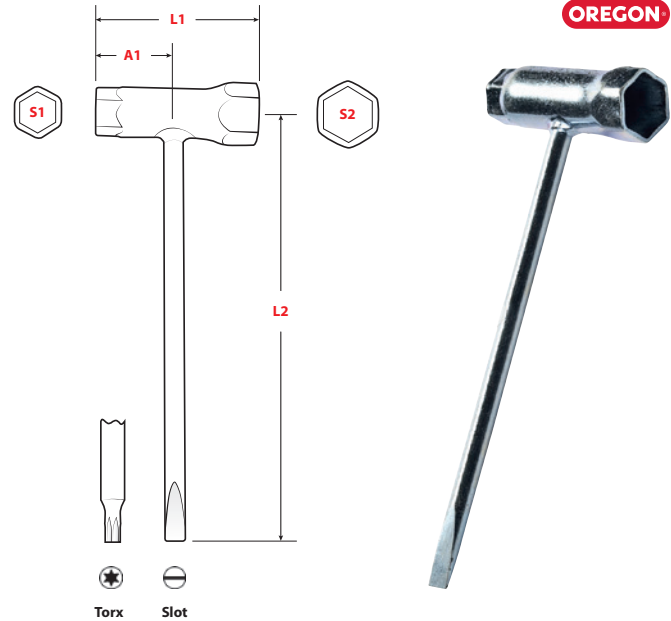

Driver Type:												
Dimensions (mm)	S1 x S2	13 x 19	13 x 19	13 x 19	19 x 10	16 x 13	19 x 17	19	19 x 14	21 x 17	15 x 19	16 x 11
	A1	25	21	33	35	35	27	12	35	30	28	40
	L2	175	177	171	172	172	177	177	175	172	177	177
	L1	52	44	68	70	72	57	51	70	60	56	80
Oregon® No's:		57-005	57-017	57-016	57-003	57-002	57-008	57-019	57-006	57-010	57-014	57-001

### Oregon Multi Tool



9 tools in one that allows the user to work on chain saws, cutoff saws, trimmers, and blowers in the field.

#### SPECS + FEATURES

- Contains convenient assortment of screw-drivers, bar groove cleaner, 4 mm Allen Wrench plus several other tools
- Nylon pouch so you can hang it on your belt and take it with you
- A set of holes in the socket allow a chain saw file to be placed and act as a file handle

SKU	SIZE	PRODUCT
57-020	Universal	MultiTool



### Oregon Bar Maintenance Kit



The Oregon Bar Maintenance Kit for chain saw chains and guide bars.

SKU	SIZE	PRODUCT
558488	5/32" File	Bar Maintenance Kit
558549	11/64" File	Bar Maintenance Kit
558550	3/16" File	Bar Maintenance Kit
558551	7/32" File	Bar Maintenance Kit
556418		Bar & Chain Replacement Measuring Tool





# spark plugs

## NGK Spark Plugs

With over 50 years of expertise, NGK Spark Plugs (U.S.A.), Inc.'s family of products are driven by perfection. Known for OE legacy, NGK Spark Plugs is at the forefront of durability and performance.



SKU	PACK	PRODUCT
92161	25	BR2-LM
92628	25	BPM8Y SOLID
97568	25	BPM7A
1172	25	BKR5E
1223	1	CMR6A
1656	10	CMR7H-10
1716	100	CS6 BKR5E
2218	10	BPMR8Y
2015	4	BPR2ES SOLID
2330	1	BCPR6ES
2460	1	BKR5ES
3066	1	CMR7H
3322	10	BR4HS
3365	1	CMR6H 1
3922	10	BR6HS
4006	1	BPR5ES SOLID
4008	4	BPR6ES SOLID
4226	10	BMR7A
4421	1	BKR4E
4549	1	CR7HSA
1589	10	BPMR7Y
5246	10	CMR4H
5574	10	BPM8Y SOLID

SKU	PACK	PRODUCT
5728	10	BMR4A
5798	1	BR2-LM
5921	10	BM6A
5113	10	BPMR4A
6130	4	BCPR5ES
6521	10	BM7A
6535	1	CR5HSB
6578	1	BPR4ES SOLID
6703	10	BPMR7A SOLID
4972	10	BPMR6A
6953	1	BKR5E-11
7022	10	BPR6HS
7131	4	BPR6ES
7321	10	BPM7A
7333	4	BP6ES
7421	10	BMR6A
7543	10	CMR7A
7558	1	ZFR5F
7599	10	CMR5H
7734	4	BPR5ES
7832	4	BP5ES
7938 4	4	BKR5E
96686	25	BMR6A SOLID



## Lucas Oil High Performance Motor Oils



### SPECS + FEATURES

- Longer oil life and fuel saving
- Lower oil temperature and better oil pressure
- Increases compression and minimizes friction
- Uses premium base oil stocks for superior performance
- Quarts of oil come in cases of 6

SKU	SIZE	CASE	PRODUCT
10275	1 Quart	6 x 1	SAE 10W-40 Plus
10276	1 Quart	6 x 1	SAE 10W-30 Plus
10252	1 Quart	6 x 1	SAE 20W-50 Plus
10053	1 Quart	6 x 1	SAE 30
10050	1 Quart	6 x 1	Synthetic SAE 10W-30
10117	5 Gallon	1 x 1	Synthetic SAE 10W-30



## Lucas Oil Heavy Duty Motor Oil



### SPECS + FEATURES

- A long-lasting upgrade replacement for CJ-4 diesel oil
- Lower oil consumption and high temperature stability
- Longer engine life and less fuel consumption
- Extended oil changes and less filter maintenance
- Lower soot levels and less oxidation
- Safely blends with other motor oils

SKU	SIZE	CASE	PRODUCT
10287	1 Gallon	4 x 1	Heavy Duty SAE 15W-40 CK-4 Motor Oil



## Lucas Oil Bag In A Box System (BIB)



### SPECS + FEATURES

- Specifically designed to be used by repair shops
- Carry multiple oil grades and specialty items for faster servicing and dispensing
- Packaging is 100% recyclable with an eco-friendly design that reduces waste by using less plastic and utilizing every drop from the oil
- Increased packaging size results in lower cost

SKU	SIZE	CASE	PRODUCT
18002	6 Gallons	1 x 1	SAE 10W-30 Plus
18055	6 Gallons	1 x 1	SAE 20W-50 Plus
18053	6 Gallons	1 x 1	SAE 30



## Lucas Oil Semi-Synthetic 2-Cycle Oils



### SPECS + FEATURES

- Exclusive additive package that burns clean and helps plugs and rings last longer
- Prevents piston burning, spark plug fouling, ring sticking, and corrosion caused by combustion residues
- Clean burning "smokeless" formula
- Used in all chainsaws, weed eaters, snowmobiles, leaf blowers, motorcycles, etc.

SKU	SIZE	CASE	PRODUCT
10058	2.6 Ounces	24 x 1	Semi-Synthetic 2-Cycle Oils
10059	6.4 Ounces	24 x 1	Semi-Synthetic 2-Cycle Oils
10120	16 Ounces	12 x 1	Semi-Synthetic 2-Cycle Oils
10110	1 Quart	6 x 1	Semi-Synthetic 2-Cycle Oils
10115	1 Gallon	4 x 1	Semi-Synthetic 2-Cycle Oils
10056	5 Gallon	1 x 1	Semi-Synthetic 2-Cycle Oils
10058-D	2.6 oz Display	24 x 1	Counter Display





## Lucas Oil Upper Cylinder Lubricant Fuel Treatment



### SPECS + FEATURES

- Cleans and lubricates the entire fuel system – greater MPG's and fewer emissions
- Fuel burns more efficiently
- Increases the life of pumps, valves, rings and injectors and solves low sulfur diesel fuel problems

SKU	SIZE	CASE	PRODUCT
10003	1 Quart	12 x 1	Upper Cylinder Lubricant Fuel Treatment
10013	1 Gallon	4 x 1	Upper Cylinder Lubricant Fuel Treatment



## Lucas Oil Safeguard Ethanol Fuel Conditioner



### SPECS + FEATURES

- Specially developed to prevent corrosion and degradation in ethanol based fuels
- Cleans and maintains injectors, carburetors and valve seats
- Protects your motor oil from the harmful side effects of alcohol combustion
- For use in 2-stroke and 4-stroke engines

SKU	SIZE	CASE	PRODUCT
10929	2 Ounces	18 x 1	Safeguard Ethanol Fuel Conditioner
10670	5.25 Ounces	24 x 1	Safeguard Ethanol Fuel Conditioner
10576	16 Ounces	12 x 1	Safeguard Ethanol Fuel Conditioner



## Lucas Oil Fuel Stabilizer



### SPECS + FEATURES

- Prevents fuel degradation and gasoline break-down during storage, preserving fuel for up to 12 months or longer
- Safe to use in all grades of gasoline and in all 2 and 4 cycle engines, inboard or outboard

SKU	SIZE	CASE	PRODUCT
10314	8 Ounces	12 x 1	Fuel Stabilizer
10302	15 Ounces	12 x 1	Fuel Stabilizer



## Lucas Oil Complete Engine Treatment



### When added to fuel:

- Cleans and lubricates the entire fuel system from the tank to injectors
- Removes harmful deposits on intake valves and cylinder heads
- Lubricates the upper cylinder walls as well as the compression rings and oil rings
- Contains special additives that cause the fuel to burn thoroughly
- Counteracts the corrosive effect of ethanol in fuel

### When added engine oil:

- Improves engine cleanliness – reduces gum and varnish, especially in oil burners
- Reduces friction and wear and helps extend oil life
- Improves cold temperature fluidity

SKU	SIZE	CASE	PRODUCT
10016	16 Ounces	12 x 1	Complete Engine Treatment



## Lucas Oil Red "N" Tacky Spray Grease



### SPECS + FEATURES

- Easy grip can with a narrow, confined spray pattern
- Solidifies quickly and clings well to the applied surface
- Resists separation and water washout, and has great heat resistance
- Excellent for cars, trucks, RVs, industrial or farm equipment, around the house and a "must" for garage doors

SKU	SIZE	CASE	PRODUCT
11025	11 Ounces Net	12 x 1	Red "N" Tacky Spray Grease



## Lucas Oil Chain Lube Aerosol



### SPECS + FEATURES

- Penetrates, lubricates and extends chain and sprocket life
- Designed to penetrate deeply into the pins and bushing of the chains
- Excellent rust and corrosion inhibitor, as well as outstanding water resistance
- Leaves a protective film to ensure minimum wear and drag
- Suitable for use in all chains including O-ring types

SKU	SIZE	CASE	PRODUCT
10393	11 Ounces Net	10 x 1	Chain Lube Aerosol



## Lucas Oil Red "N" Tacky Grease



### SPECS + FEATURES

- NLGI GC-LB Certified #2
- A technical blend of lithium and polymers plus a heavy addition of "anti-wear" / "anti-seize" agents
- Excellent for use in trucks, cars, industrial and farm equipment, boat trailers and wheel bearings
- Provides high levels of temperature stability, chassis protection, resistance to acid and alkali and resistance to rust and corrosion

SKU	SIZE	CASE	PRODUCT
10318	3 Ounces Net	10 x 1	Red "N" Tacky Grease
10574	1 Pound Net	12 x 1	Red "N" Tacky Grease



## Lucas Oil Brake Parts Cleaner (50 states)



### SPECS + FEATURES

- Effectively removes brake fluid, grease, brake dust and other contaminants from brake linings, pads, cylinders, springs and drums
- Use on all ABS, disc and drum brakes
- Quiets noise associated with excessive brake dust
- Professional strength, dries fast and leaves no residue

SKU	SIZE	CASE	PRODUCT
10906	14 Ounces Net	12 x 1	Chain Lube Aerosol





**LUCAS OIL**

## Lucas Oil Penetrating Oil

### SPECS + FEATURES

- Use on nuts, bolts, bearings, hinges, sliding doors or a million other home and shop uses
- Contains no chlorine, fluorocarbons or silicon
- Excellent protection against water, even salt water and provides a microscopic film that rust proofs for up to a year
- A truly superior, low odor penetrate fortified with anti-seize agents designed to dissolve corrosion and rust without drying

SKU	SIZE	CASE	PRODUCT
11043	11 Ounces Net	12 x 1	Penetrating Oil



## Lucas Oil Multi-Purpose Parts Cleaner & Degreaser

### SPECS + FEATURES

- Formulated with advanced Polyetheramine (PEA) detergents to clean and degrease carburetors, chokes, brake calipers, rotors, air intakes, throttle bodies and unpainted metal parts
- Removes any build-up that can cause loss of power, rough idle, high emissions and hard starting
- Will not harm catalytic converters and oxygen sensors

SKU	SIZE	CASE	PRODUCT
11115	16 Ounces Net	12 x 1	Multi-Purpose Parts Cleaner & Degreaser

**LUCAS OIL**

## Lucas Oil Universal Hydraulic & Transmission Fluid

### SPECS + FEATURES

- Extends equipment and fluid life
- Reduces downtime and major over-haul
- Seal conditioning additive keeps seals soft and pliable, preventing them from hardening and cracking
- Meets all OEM specifications for power shift transmissions, including gears, pumps, differentials, final drives, bearings, wet brakes, transmissions and PTO clutches
- 55 gallon drums available for dropship only

SKU	SIZE	CASE	PRODUCT
10017	1 Gallon	4 x 1	Universal Hydraulic & Transmission Fluid
10037	5 Gallons	1 x 1	Universal Hydraulic & Transmission Fluid
10038	55 Gallons	1 x 1	Universal Hydraulic & Transmission Fluid

**LUCAS OIL**

## Lucas Oil Anti-Wear Hydraulic Oils



### SPECS + FEATURES

- Up to 12,000 hour rating
- Cleanliness Rating of 16/14/11
- Excellent wear protection in critical hydraulic pump parts
- Eliminates rust, corrosion and minimizes foam
- Designed for use in machine tools, presses, die casting, airline lubricators, reciprocating air compressors, circulating systems, hydraulic control systems and plain and anti-friction bearings
- 55 gallon drums available for dropship only

SKU	SIZE	CASE	PRODUCT
10401	5 Gallons	1 x 1	AW ISO 32
10403	55 Gallons	1 x 1	AW ISO 32
10404	5 Gallons	1 x 1	AW ISO 46
10406	55 Gallons	1 x 1	AW ISO 46
10407	5 Gallons	1 x 1	AW ISO 68
10409	55 Gallons	1 x 1	AW ISO 68
10672	55 Gallons	1 x 1	AW ISO 150



## Lucas Oil Synthetic Universal Hydraulic & Transmission Fluid



### SPECS + FEATURES

- Longer component and fluid life
- Expect more hydraulic pressure, faster response and smoother operation
- Designed for all temperature extremes
- 55 gallon drums available for dropship only

SKU	SIZE	CASE	PRODUCT
10100	5 Gallons	1 x 1	Synthetic Universal Hydraulic & Transmission Fluid
10524	55 Gallons	1 x 1	Synthetic Universal Hydraulic & Transmission Fluid



## Lucas Oil Non-Conductive Anti-Wear Hydraulic Oils



### SPECS + FEATURES

- Reduces deposits and sludge
- Excellent wear protection
- Excellent oxidative and thermal stability
- Recommended for use wherever non-conductive fluids are required
- Dielectric Strength of 38 Kv makes it an excellent non-conductive fluid
- High flash point reduce danger of fire
- 55 gallon drums available for dropship only

SKU	SIZE	CASE	PRODUCT
10691	5 Gallons	1 x 1	AW ISO 22
10692	55 Gallons	1 x 1	AW ISO 22
11107	5 Gallons	1 x 1	AW ISO 32
11108	55 Gallons	1 x 1	AW ISO 32







## VP Small Engine Fuels

NOTE: This is a drop ship only product. Minimum order parameters exist.

### SPECS + FEATURES

- Prevent ethanol-related problems
- Provides easier, more dependable starts
- Remains stable in storage
- Through the off-season and beyond
- Extends engine life
- Improves equipment performance
- 55 gallon drums available

SKU	SIZE	CASE QTY	PRODUCT
SPS8715	5' x 10'	100	Stickers, VP S.E.F.
VP2805	16 oz	9	Fuel System Cleaner
VP2815	8 oz	9	Fuel Stabilizer with Ethanol Shield™
VP2825	16 oz	9	Power Boost, Fuel Cleaner
VP2835	24 oz	9	Diesel All-In-One
VP2855	1 quart	8	Octanium™
VP2865	1 quart	8	Cetanium Diesel Treatment
VP2909	2.6 oz	12	2 Cycle Synthetic Oil - Mix for 1 Gallon
VP2910	5.2 oz	12	2 Cycle Synthetic Oil - Mix for 2 Gallon
VP2906	12.8 oz	12	2 Cycle Synthetic Oil - Mix for 5 Gallon
VP2911	18 oz	12	4 Cycle 30WT Small Engine Oil
VP2913	32 oz	12	4 Cycle 30WT Small Engine Oil
VP2921	32 oz	12	4 Cycle 10/30WT Syn Small Engine Oil
VP2931	32 oz	12	Bar and Chain Oil
VP2933	1 gallon	4	Bar and Chain Oil
VP2941	2.5 gallon	2	Hydraulic Oil
VP6201	1 gallon	4	Fuel, VP, 4 Cycle
VP6202	5 gallon	1	Fuel, VP, 4 Cycle
VP6204	54 gallon	1 (Drum)	Fuel, VP, 4 Cycle
VP6205	1 quart	8	Fuel, VP, 4 Cycle
VP6231	1 gallon	4	Fuel, VP, 50:1 Premix
VP6232	5 gallon	1	Fuel, VP, 50:1 Premix
VP6234	54 gallon	1 (Drum)	Fuel, VP, 50:1 Premix
VP6235	1 quart	8	Fuel, VP, 50:1 Premix
VP6291	1 gallon	4	Fuel, VP, 40:1 Premix
VP6292	5 gallon	1	Fuel, VP, 40:1 Premix
VP6294	54 gallon	1 (Drum)	Fuel, VP, 40:1 Premix
VP6295	1 quart	8	Fuel, VP, 40:1 Premix
VP6632	5 gallon	1	Fix-It Fuel™, VP Fuel Treatment
VP6635	1 quart	8	Fix-It Fuel, VP Fuel Treatment
VP68111	1 gallon	4	Multi-Mix 40:1/50:1
VP6812	5 gallon	1	Fuel, VP, Multi-Mix 40:1/50:1
VP6814	54 gallon	1 (Drum)	Fuel, VP, Multi-Mix 40:1/50:1
VP6815	1 quart	8	Multi-Mix 40:1/50:1

SKU	SIZE	CASE QTY	PRODUCT
VP6832	5 gallon	1	Promax™ (50:1 Premix, 97 Octane)
VP6834	54 gallon	1 (Drum)	Promax (50:1 Premix, 97 Octane)
VP6835	1 quart	8	Promax (50:1 Premix, 97 Octane)
VP3051	-	1	Pump, Siphon for VP 54 Gallon Drum
VP348	-	1	Spout, VP Fuel Power Spout
VP3698	-	1	Display, Pop, 1 Shelf, Cardboard
VP3756	-	1	Display, Pop, 4 Shelf, Plastic
VP9437	2' x 4'	1	Banner, VP Small Engine Fuel I/O
VPM10011	1 gallon	4	Powerwash™ Concentrate
VPM10025	1 quart	12	Powerwash Spray Bottle - Moto Formula



55 GALLON DRUMS AVAILABLE BY DROPSHIP

# chain grinders

## Oregon Grinder 12v Electric Sure Sharp®

OREGON

### SPECS + FEATURES

- Includes both a 12-volt car adapter and battery clips for convenient use anywhere
- Includes one each 5/32" (4.0 mm), 3/16" (4.8 mm) and 7/32" (5.5 mm) sharpening stones and a collet wrench
- Simple sharpening angle adjustment guide for accuracy
- Sharpens any round-ground 1/4", 3/8" Low Profile, .325", 3/8" or .404" chain
- High impact housing holds a powerful motor that runs at an optimum 25,000 rpm
- Shank lock feature allows easier stone replacement
- Replacement sharpening stones available



SKU	SIZE	PRODUCT
585015	-	12v Electric Sure Sharp Grinder
31396	3/16"	3-Pack sharpening stones
31397	5/32"	3-Pack sharpening stones
31398	7/32"	3-Pack sharpening stones

## Oregon Hydraulic Assisted Bench Grinder, 120V

OREGON

Providing the convenience and quality you need from a workhorse, the 620-series high-volume saw chain grinder features a hydraulic assist clamping vise, eliminating the need to manually tighten and loosen the vise.

### SPECS + FEATURES

- Single phase, direct-drive, one-way, 120V, 60Hz, 4.3A, 300W, 3400 RPM, 0.4 HP motor.
- Hydraulic assist chain clamping vise.
- Grinds 1/4", 3/8" Low Profile, .325", 3/8", .404", & 3/4" pitch saw chain out of the box
- Weight: 21 lbs.
- Height: 19-1/2"

SKU	PRODUCT
620-120	Hydraulic Assist, Saw Chain Bench Grinder



## Oregon Mid-Sized Bench Grinder, 120V

OREGON

Mid-sized bench grinder that provides the quality of Oregon at an exceptional value.

### SPECS + FEATURES

- Single phase, direct-drive, one-way, 120V, 60Hz, 1.2A, 140W, 3500 RPM, 0.4 HP motor.
- Manual chain-clamping vise.
- Grinds 1/4", 3/8" Low Profile, .325", 3/8", & .404" pitch saw chain out of the box
- Weight: 17 lbs.
- Height: 16"

SKU	PRODUCT
410-120	Mid-Sized, Saw Chain Bench Grinder





## Oregon Saw Chain Bench Grinder

**OREGON**

520-series saw chain grinder combines premium quality and ease of use for high volume sharpening, featuring a sharp design and an newly engineered vise for improved performance.

### SPECS + FEATURES

- Single phase, direct-drive, one-way, 120V, 60Hz, 4.3A, 300W, 3400 RPM, 0.4 HP motor.
- Manual chain-clamping vise.
- Grinds 1/4", 3/8" Low Profile, .325", 3/8", & .404" pitch saw chain out of the box
- Weight: 20 lbs.
- Height: 19-1/2"

SKU	PRODUCT
520-120	Saw Chain Grinder



## Oregon Light-Duty, Saw Chain Bench Grinder

**OREGON**

Designed with the occasional user in mind, the compact 310-series consumer bench grinder delivers precision results in a very small space and sharpens up to .404" pitch chain.

### SPECS + FEATURES

- Single phase, direct-drive, one-way, 120V, 60Hz, 0.6A, 85W, 4600 RPM, 0.11 HP motor.
- Manual chain-clamping vise.
- Grinds 1/4", 3/8" Low-Profile, .325", 3/8", & .404" out of the box
- Weight: 15 lbs.
- Height: 13"

SKU	PRODUCT
310-120	Light-Duty, Saw Chain Bench Grinder



Image courtesy of Oregon



# Log Weight Chart by Diameter

Weight of a one-foot section (based on average diameter)

ANSI Z133.1/5.7.7 states that "A green log weight chart shall be available to the crew."

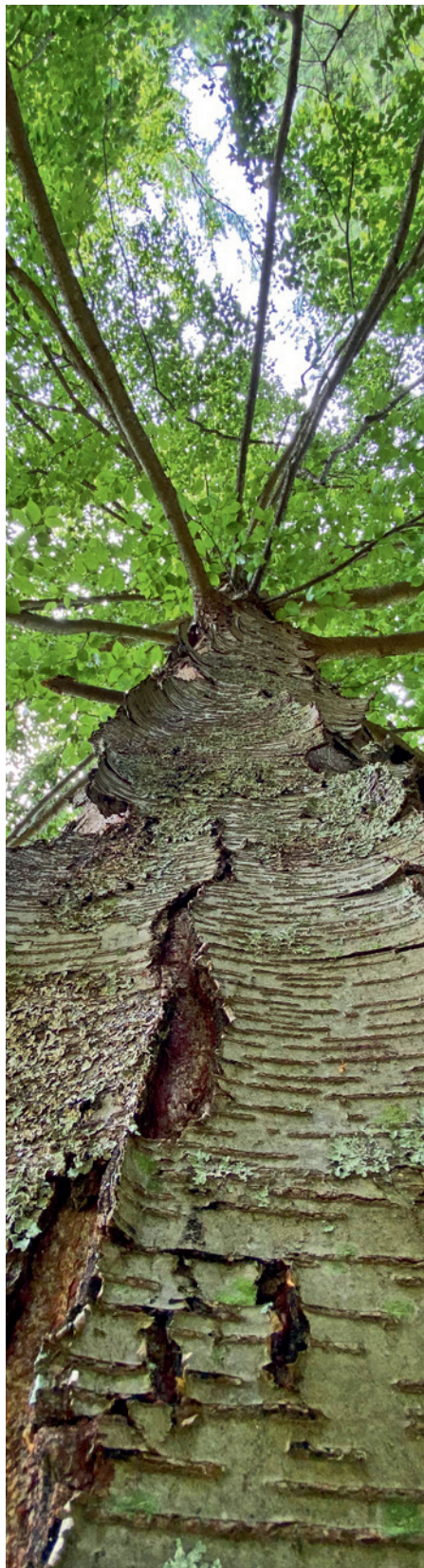

SPECIES	WEIGHT PER CUBIC FT	10"	12"	14"	16"	18"	20"	22"	24"	26"	28"	30"	32"	34"	36"
Alder, red	46	25	36	49	64	81	100	121	145	170	197	226	257	290	325
Apple	55	30	43	59	77	97	120	145	173	203	235	270	307	347	389
Ash, green	47	26	37	50	66	83	103	124	148	173	201	231	262	296	332
Ash, Oregon	48	26	38	51	67	85	105	127	151	177	205	236	268	293	339
Ash, white	48	26	38	51	67	85	105	127	151	177	205	236	268	293	339
Aspen, quaking	43	23	34	46	60	76	94	114	135	159	184	211	240	271	304
Bald Cypress	51	28	40	55	71	90	111	135	160	188	218	250	285	322	360
Basswood	42	23	33	45	59	74	92	111	132	155	180	206	235	265	297
Beech	54	29	42	58	75	95	118	143	170	199	231	265	302	340	382
Birch, paper	50	27	39	53	70	88	109	132	157	184	214	245	279	315	353
Birch, yellow	57	31	45	61	80	101	124	150	179	210	244	280	318	359	403
Butternut	46	25	36	49	64	81	100	121	145	170	197	226	257	290	325
Cedar, incense	45	25	35	48	63	80	98	119	141	166	192	221	251	284	318
Cedar, west red	28	15	22	30	39	49	61	74	88	103	120	137	156	177	198
Cherry, black	45	25	35	48	63	80	98	119	141	166	192	221	251	284	318
Chestnut	55	30	43	59	77	97	120	145	173	203	235	270	307	347	389
Chinaberry	50	27	39	53	70	88	109	132	157	184	214	245	279	315	353
Cottonwood	49	27	38	52	68	87	107	129	154	181	210	241	274	309	346
Elm, American	54	29	42	58	75	95	118	143	170	199	231	265	302	340	382
Fir, Douglas	39	21	31	42	54	69	85	103	123	144	167	191	218	246	276
Fir, noble	29	16	23	31	40	51	63	77	91	107	124	142	162	183	205
Fir, white	47	26	37	50	66	83	103	124	148	173	201	231	262	296	332
Gum, black	45	25	35	48	63	80	98	119	141	166	192	221	251	284	318
Gum, red	50	27	39	53	70	88	109	132	157	184	214	245	279	315	353
Hackberry	50	27	39	53	70	88	109	132	157	184	214	245	279	315	353
Hemlock, eastern	49	27	38	52	68	87	107	129	154	181	210	241	274	309	346
Hemlock, western	41	22	32	44	57	72	89	108	129	151	175	201	229	259	290
Hickory, Shagbark	64	35	50	68	89	113	140	169	201	236	274	314	357	404	452
Honeylocust	63	34	49	67	88	111	137	166	198	232	269	309	352	397	445
Horsechestnut	41	22	32	44	57	72	89	108	129	151	175	201	229	259	290
Larch	51	28	40	55	71	90	111	135	160	188	218	250	285	322	360
Locust, black	58	32	46	62	81	102	127	153	182	214	248	285	324	366	410
Locust, Honey	61	33	48	65	85	108	133	161	192	225	261	299	341	385	431
Magnolia	59	32	46	63	82	104	129	156	185	218	252	290	330	372	417
Maple, red	50	27	39	53	70	88	109	132	157	184	214	245	279	315	353
Maple, silver	45	25	35	48	63	80	98	119	141	166	192	221	251	284	318
Maple, sugar	56	31	44	60	78	99	122	148	176	206	239	275	313	353	396
Oak, black	62	34	49	66	87	110	135	164	195	229	265	304	346	391	438
Oak, Cali. black	66	36	52	71	92	117	144	174	207	243	282	324	369	416	467
Oak, English	52	28	41	56	73	92	113	137	163	192	222	255	290	328	368
Oak, live	76	41	60	81	106	134	166	201	239	280	325	373	424	479	537
Oak, pin	64	35	50	68	89	113	140	169	201	236	274	314	357	404	452
Oak, post	63	34	49	67	88	111	137	166	198	232	269	309	352	397	445
Oak, red	63	34	49	67	88	111	137	166	198	232	269	309	352	397	445
Oak, scarlet	64	35	50	68	89	113	140	169	201	236	274	314	357	404	452
Oak, white	62	34	49	66	87	110	135	164	195	229	265	304	346	391	438
Osage, orange	62	34	49	66	87	110	135	164	195	229	265	304	346	391	438
Pecan	61	33	48	65	85	108	133	161	192	225	261	299	341	385	431
Persimmon	63	34	49	67	88	111	137	166	198	232	269	309	352	397	445
Pine, loblolly	53	29	42	57	74	94	116	140	167	195	227	260	296	334	375
Pine, lodgepole	39	21	31	42	54	69	85	103	123	144	167	191	218	246	276
Pine, longleaf	55	30	43	59	77	97	120	145	173	203	235	270	307	347	389
Pine, ponderosa	46	25	36	49	64	81	100	121	145	170	197	226	257	290	325
Pine, slash	58	32	46	62	81	102	127	153	182	214	248	285	324	366	410
Pine, sugar	52	28	41	56	73	92	113	137	163	192	222	255	290	328	368
Pine, white	36	20	28	38	50	64	79	95	113	133	154	177	201	227	254
Poplar, yellow	38	21	30	41	53	67	83	100	119	140	162	187	212	240	269
Redwood, coastal	50	27	39	53	70	88	109	132	157	184	214	245	279	315	353
Sassafras	44	24	35	47	61	78	96	116	138	162	188	216	246	277	311
Spruce, Red	34	19	27	36	47	60	74	90	107	125	145	167	190	214	240
Spruce, Sitka	32	17	25	34	45	57	70	84	101	118	137	157	179	202	226
Sweetgum	55	30	43	59	77	97	120	145	173	203	235	270	307	347	389
Sycamore	52	28	41	56	73	92	113	137	163	192	222	255	290	328	368
Tamarack	47	26	37	50	66	83	103	124	148	173	201	231	262	296	332
Walnut, black	58	32	46	62	81	102	127	153	182	214	248	285	324	366	410
Willow	32	17	25	34	45	57	70	84	101	118	137	157	179	202	226

Information from the U.S. Department of the Interior, National Park Service sheet "Rope, Knots and Climbing".



# 10 | cabling + bracing



CABLE .....	278
CABLING SUPPLIES + ACCESSORIES ...	279
HARDWARE + BRACING .....	280
THIMBLES, WASHERS, NUTS .....	281
WIRE STOPS .....	282
WOOD BORING BITS .....	284
EARTH ANCHORS .....	285



# cable

## Common Grade Cable Coil 250'

### SPECS + FEATURES

- Grade A
- Galvanized, 7 strand construction
- Great for hand splicing
- 1/8" MBS: 540 lbs
- 3/16" MBS: 1,150 lbs
- 1/4" MBS: 1,900 lbs
- 5/16" MBS: 3,200 lbs
- 3/8" MBS: 4,250 lbs

SKU	SIZE	PRODUCT
2G1C125-00250	1/8	Cable Coil 250' (small diameter coil)
G1S125B-250-COIL	1/8	Cable Coil 250' (standard diameter coil)
G1S125B-MG-ON SPOOL	1/8	Cable Spool 250' (wooden spool)
COMMON GRADE	3/16	Cable Coil 250'
14ACOM7	1/4	Cable Coil 250'
516ACOM7	5/16	Cable Coil 250'
38ACOM7	3/8	Cable Coil 250'



## EHS Cable Coil 250'

**EHS** (Extra High Strength) has many field or trade names often called guy strand, guy wire or guide wire but they normally refer to 1x7 **EHS** galvanized strand cable.

Designed with very little stretch and flexibility this cable is generally used to reinforce and add stability to tall structures; reinforcing everything from radio towers to wind turbines and is ideal for bracing and tensioning applications for utility work and for arborists for cabling trees.

### SPECS + FEATURES

- 1x7 EHS Galvanized, Left hand lay
- 3/16: MBS 3,990 lbs; 18 lbs Weight / 250'
- 1/4: MBS 6,650 lbs; 30 lbs Weight / 250'
- 5/16: MBS 11,200 lbs; 52.5 lbs Weight / 250'
- 3/8: MBS 15,400 lbs; 62.5 lbs Weight / 250'
- Class A galvanized, meets ASTM A-475, independent lab verified/quality assured

SKU	SIZE	ATTRIBUTE	PRODUCT
316AEHS7	3/16		Cable Coil 250'
14AEHS7	1/4		Cable Coil 250'
516AEHS7	5/16		Cable Coil 250'
38AEHS7	3/8		Cable Coil 250'



Guide wire dispenser not included.





# cabling supplies + accessories

## Guy Wire Dispenser

### SPECS + FEATURES

- 250 ft. typical coil size accommodated (not reusable):  
3/16", 3/8", 1/4", 7/16", 5/16", and 1/2"
- GWD 1000 will accommodate a coil of strand up to 63" in diameter.

SKU	SIZE	ATTRIBUTE	PRODUCT
GWD1000			Cable Dispenser

### SAFETY CONSIDERATIONS

- 1) This product is for a specific application.
- 2) This product should not be used by anyone who is not familiar with its use.
- 3) GWD 1000 is designed to withstand a 15 ft. Free fall impact of a 200 lb. coil.

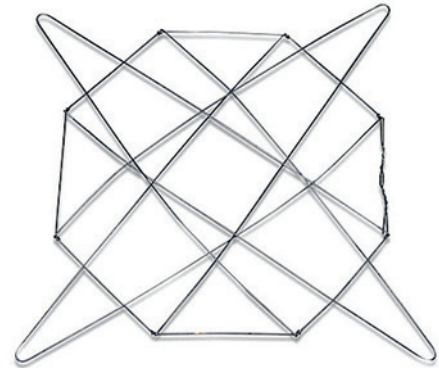

SEE AFTER INSTALLED  
ON PAGE 278

## BUCK Cable Cage

A new design with strength where it is needed. Reusable. Raise the pivot swing arm, drop in the coil of cable, lower the arm, secure using the bolt and wing nut, cut bands and feed strand. No unneeded metal bands with this sturdy tool. Handles full coils with ease while storing partially used ones safely.

6 1/2" D x 30" W. Weight 10 lbs.

SKU	SIZE	ATTRIBUTE	PRODUCT
6150			Cable Cage



BUCKINGHAM  
**BUCK**  
1886

## Cable Puller with Latch 1/8"-1/2"

Designed for use on EHS and Common Grade Guy Strand. Latch helps hold the cable in the jaw.

- Options: Locking or Non-Locking
- Capacity: 1/8" - 1/2"
- Working Load Limit: 4,600 lbs
- Weight: 2.64 lbs/ea

SKU	ATTRIBUTE	PRODUCT
WGRIP125-500-WL	LOCKING	Cable Puller
WGRIP125-500	NON-LOCK	Cable Puller



# hardware + bracing

## Eye Bolt Oval

### SPECS + FEATURES

- Steel, Hot Dip Galvanized, UNC Threading, Includes Square Nut
- 1/2" Bolt - 7800 lb rated Tensile Strength; 8" has 4" thread, 12" has 6" thread. Eye size is 1 1/4" x 1 5/8"
- 5/8" Bolt - 12,400 lb rated Tensile Strength; 8" has 4" thread, 12" has 6" thread, 18" has 6" thread. Eye size is 1 1/2" x 2"

SKU	SHANK	ATTRIBUTE	PRODUCT
29937	6"	1/2" Oval	Eye Bolt Oval 1/2
29939	8"	1/2" Oval	Eye Bolt Oval 1/2
29958	8"	5/8" Oval	Eye Bolt Oval 5/8
29962	12"	5/8" Oval	Eye Bolt Oval 5/8
29968	18"	5/8" Oval	Eye Bolt Oval 5/8



## Eye Bolt Round

### SPECS + FEATURES

- Drop Forged, Hot Galvanized, UNC Threading
- 1/4" Bolt - Includes Nut, WLL: 650 lbs, Min Thread: 2", Eye Size: 0.50"
- 3/8" Bolt - Includes Nut, WLL: 1,550 lbs, Min Thread: 3", Eye Size: 0.75"
- 1/2" Bolt - Includes Nut, WLL: 2,600 lbs, Min Thread: 3-9", Eye Size: 1"
- 5/8" Bolt - Includes Nut, WLL: 4,750 lbs, Min Thread: 12", Eye Size: 1.25"

SKU	SHANK	ATTRIBUTE	PRODUCT
EB250X04	4"	1/4" Round	Eye Bolt Round 1/4
EB375X06	6"	3/8" Round	Eye Bolt Round 3/8
EB500X06	6"	1/2" Round	Eye Bolt Round 1/2
EB500X08	8"	1/2" Round	Eye Bolt Round 1/2
EB500X10	10"	1/2" Round	Eye Bolt Round 1/2
EB500X12	12"	1/2" Round	Eye Bolt Round 1/2
EB500X18	18"	1/2" Round	Eye Bolt Round 1/2
EB625X24	24"	5/8" Round	Eye Bolt Round 5/8



## J Lag Hooks

### SPECS + FEATURES

- Typically used in short cabling runs where opposite threaded lags can be used, one on each end, and turned to tension the guy strand.
- Zinc plated for corrosion protection.
- ANSI Tree Care Operations, "Tree, Shrub and Other Woody Plant Management" ANSI A300 (Supplemental Support Systems).

SKU	SIZE	ATTRIBUTE	PRODUCT
LHK375X04-R	RIGHT	3/8 X 6"	J Lag 3/8 X 6"
LHK375X04-L	LEFT	3/8 X 6"	J Lag 3/8 X 6"
LHK500X6-NR	RIGHT	1/2 X 6"	J Lag 1/2 X 6"
LHK500X6-NL	LEFT	1/2 X 6"	J Lag 1/2 X 6"
LHK625X07-R	RIGHT	5/8 X 6"	J Lag 5/8 X 6"
LHK625X07-L	LEFT	5/8 X 6"	J Lag 5/8 X 6"



## Screw Rod Lag Thread and Nuts

**Screw Rod** is an important option for use on trees with very weak or cracked unions. Built with lag screw thread to allow better holding capacity when either applying a nut and washer or cutting to be underneath the cambium..

SKU	SIZE	ATTRIBUTE	PRODUCT
R180001-161	1/2	6'	Screw Rod Lag Thread
R180002-062	5/8	6'	Screw Rod Lag Thread
R180003-06	3/4	6'	Screw Rod Lag Thread
N140001-00	1/2		Screw Rod Nut
N140002-50	5/8		Screw Rod Nut
N140003-00	3/4		Screw Rod Nut

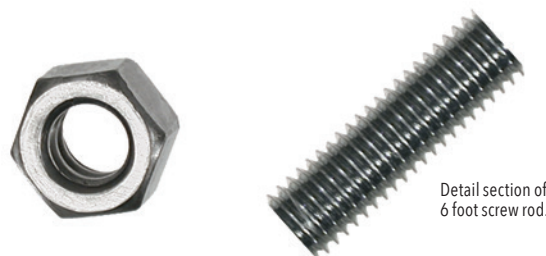

Detail section of 6 foot screw rod.



# thimbles, washers, nuts

## Thimbles – Standard/Heavy Duty, Galvanized

### SPECS + FEATURES

- 1/8" Thimble: Inside Length: 1.30", Width: .70"
- 3/16" Thimble: Inside Length: 1.35", Width: .8"
- 1/4" Thimble: Inside Length: 1.65", Width: .89"
- 5/16" Thimble: Inside Length: 1.9", Width: 1.04"
- 3/8" Thimble: Inside Length: 2.20", Width: 1.15"

SKU	SIZE	ATTRIBUTE	PRODUCT
TSD125X100	1/8	Standard	Thimble
THD187	3/16	Heavy	Thimble
THD250DP	1/4	Heavy	Thimble
THD312DP	5/16	Heavy	Thimble
THD375DP	3/8	Heavy	Thimble



## Helical Grips

Helical preformed tree grips eliminate the need to "hand splice" cable ends onto hardware, saving you time and money.

### SPECS + FEATURES

- Must be used with heavy-duty thimbles
- Material: Class A galvanized steel
- For use with Extra High Strength cable only

SKU	SIZE	ATTRIBUTE	PRODUCT
HTG105 3/16	3/16 RED	3/16"	Helical Grips
HTG107 1/4	1/4 YELL	1/4"	Helical Grips
HTG109 5/16	5/16 BLK	5/16"	Helical Grips
HTG110 3/8	3/8 ORG	3/8"	Helical Grips



## Galvanized Flat Washer

Zinc-coated flat washers used as seat for fastening and tightening eye bolts to trees.

SKU	SIZE	PRODUCT
FWUSS06G	3/8	Galvanized Flat Washer
FWUSS08G	1/2	Galvanized Flat Washer
FWUSS10G	5/8	Galvanized Flat Washer
FWUSS12G	3/4	Galvanized Flat Washer
FWUSS087	7/8	Galvanized Flat Washer



## Cable Ring

This thermal treated, zinc-plate, hot forged alloy steel ring is great for hub and spoke cabling systems, as well as rigging applications.

Also used as friction saver rings to allow for large eye passage or two attached lines. Ultimate Load: 150 kN (33,750 lbs.) Approximate weight: 10 oz.

SKU	SIZE	ATTRIBUTE	PRODUCT
20041G			Cable Ring



## Oval Eye Bolt Nut

Nuts used to anchor pass through eye bolts in trees

SKU	SIZE	PRODUCT
55083P	1/2	Oval Eye Bolt Nut
HNF08CG	1/2	Nut Galvanized
HNF10CG	5/8	Nut Galvanized
HFN1-3Q10	3/4	Nut Zinc Coated
HFN1-7E9	7/8	Nut Zinc Coated



## Amon Oval Eye Nut

### SPECS + FEATURES

- 1/2" – Threaded; Eye Size: 1.75 x 1.5"; Iron; Finish: Hot Dip Galvanized
- 5/8" – Threaded; Eye Size: 1.5 x 1.75"; Steel; Finish: Hot Dip Galvanized

SKU	SIZE	ATTRIBUTE	PRODUCT
6500 1/2	1/2	Iron	Amon Eye Nut
6502	5/8	Steel	Amon Eye Nut



# wire stops

## RigGuy WireStop®

**RIGGUY®**

The faster and more economical way to cable trees. The internal taper fits over the middle strand of 7-strand EHS cable with the six remaining strands surrounding it.

Wire Stop eliminates the need for the J lag, or eye, hooks, thimbles, through bolts, pre-formed wraps, wire rope clips, or other terminal hardware. It can be used in more applications because it is secured on the outside of the limb or trunk. Because of its small size and simplicity, it makes a more finished and less cluttered installation.

SKU	SIZE	PRODUCT
201	3/16-1/4	Wire Stop (Block & Cone)
101	5/16-3/8	Wire Stop (Block & Cone)
5/16 CONE ONLY	5/16-3/8	Cone Only
101B	5/16-3/8	Block Only
201B	1/4-3/16	Block Only

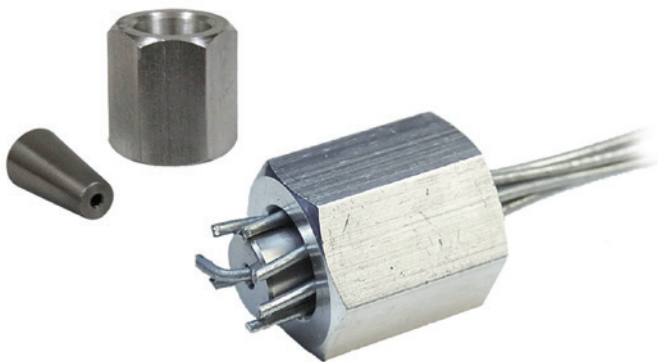

## RigGuy WireStop Hub

**RIGGUY®**

Use the hub with 3 WireStops to cable three trunks or leaders together. The hub solution is less damaging than triangulation because it only requires three holes instead of six. It also requires less than half the parts (13) required in a traditional system installation (31).

SKU	PRODUCT
501	3 WireStops Hub

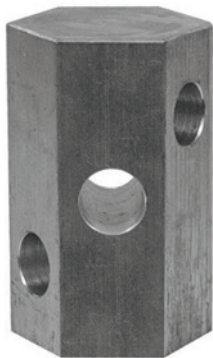

## RigGuy WireStop Finishing Cap

**RIGGUY®**

The **Finishing Cap Not** is a necessary holding component of the Wire Stop. It does however, give a finished appearance and protection from exposed wire ends. The cap is made from UV protected vinyl. (Sold separately.)

SKU	SIZE	ATTRIBUTE	PRODUCT
101F	5/16-3/8		Finishing Cap
201F	3/16-1/4		Finishing Cap



## RigGuy WireStop Round

**RIGGUY®**

### SPECS + FEATURES

- It was specifically developed for use on smaller trees. (Dogwoods, Bradfords etc.)
- Measures only 11/16" wide by 1/2" long

SKU	SIZE	ATTRIBUTE	PRODUCT
301	3/16		Round 301



## ENDZ Cable Stops

### SPECS + FEATURES

- Eliminates the need for grips, thimbles and eye bolts.
- Designed for use with 5/16 - 7 strand EHS cable only

SKU	SIZE	PRODUCT
ENDZ 5/16		For 5/16 EHS
CENTER CONE ONLY		Center Cone

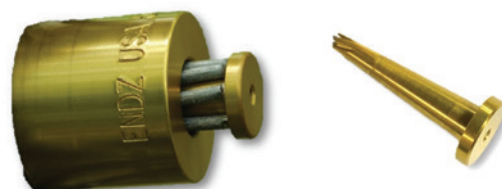





Photo by Caleb Mende

## How does a Wire Stop work?

The six wires surrounding the internal taper are pulled deeper into the block as the pressure from the tree increases. This inward movement locks the captured wires ever tighter between the internal taper and the external block. The seventh wire (the center wire) is bent over the taper to hold the system in place if the cable slacks in the wind.

## Does they conform to the ANSI A300 standards?

Yes, the Wire Stop conforms to all the “should” clauses in the standards. We have petitioned the ANSI Standards Committee to include the Wire Stop (or a generic name) in the upcoming revision of the standards.

## How do Wire Stops compare to traditional terminal hardware?

	WIRE STOP	TRADITIONAL TERMINAL HARDWARE
<b>Length</b>	1.25 inches	1.5 feet
<b>Weight</b>	2.3 oz	1 lb 11 oz
<b>Strength</b>	Virtually 100% of strand	Limited to weakest part
<b>Wear</b>	No metal to metal rubbing	Thimble rubs strand and eye bolt
<b>Bore size in tree</b>	7/16th of an inch	11/16th of an inch
<b>Parts per end</b>	2	5
<b>Installation time</b>	2-3 min per end	10 min or more per end
<b>Versatility</b>	No minimum distance between limbs	Need 5 feet between limbs
<b>Appearance</b>	Extends only 1.25 inches outside of limb	Extends 1.5 feet on inside of limb and also out the back

All comparisons using 3/8" EHS strand

‘ve been using **Rig Guy cable stops** for almost ten years now, I am continually amazed at how easy they are to use. Back in the day, I used to do my cabling with a gas-powered drill, large and heavy eye bolts, nuts, washers, thimbles, and preforms. I now get my Makita battery drill, put the **Rig Guy stops** in my pocket, grab my Felco cable snips, get to the cabling spot, and I am ready to go! **Rig Guys** mean a less intrusive wound for the tree as the wound is only the diameter of the cable being used. And the final look of the cabling is neat: a couple of small bumps on the sides of the tree. I can't recommend them enough!"

—John, Swepston Arbor Works, Vermont



# wood boring bits

## Irwin Power Drill Power Pole Auger Bit

Irwin ship auger bits are the arborists choice for hardware installation in trees.

### SPECS + FEATURES

- Single spur, cutter, and side lip design bore through creosoted poles without clogging, binding, or stopping to clear chips
- Extra-long twist is ideal for boring large poles, construction timbers, and for multiple timber applications
- All bits feature 7/16" adaptable hex shank (simply remove it to use round shank)
- Full-length heat treatment guards against bending in heavy-duty applications and strengthens the twist where the greatest strain occurs
- Bit can be resharpened
- Medium-fast screw point ideal for general wood-boring applications

SKU	SIZE	ATTRIBUTE	PRODUCT
46911	23"	11/16	Drill Bit 11/16
47011	29"	11/16	Drill Bit 11/16
46909	23"	9/16	Drill Bit 9/16
47009	29"	9/16	Drill Bit 9/16
47010	29"	5/8	Drill Bit 5/8



## 303DLX Heavy Duty Ship Augers

### SPECS + FEATURES

- Molybdenum coated for cooler running
- Glides through wood with less binding, bores faster
- Ejects chips faster
- Stays sharper longer
- No run out, machined to a true center
- 7/16" x 18" (twist length: 15"), or 7/16" x 24" (twist length: 21")
- 3/8" x 18" (twist length: 15"), or 3/8" x 24" (twist length: 21")
- Buy augers 1/16" larger than EHS strand used. Ex. 1/4" strand buy 5/16" auger

SKU	SIZE	PRODUCT
7/16X18" HD SHIP AUGER	18"	Drill Bit HD Ship Auger 7/16
7/16X24" HD SHIP AUGER	24"	Drill Bit HD Ship Auger 7/16
3/8X18" HD SHIP AUGER 303DLX	18"	Drill Bit HD Ship Auger 3/8
3/8X24" HD SHIP AUGER	24"	Drill Bit HD Ship Auger 3/8



## General Purpose Auger Bit 7/16"

Wood auger bits are designed to drill clean, deep holes in wood.

### SPECS + FEATURES

- Variant Description: Auger Bit 7/16 X 17in OAL - 3/8 in Shank

SKU	SIZE	ATTRIBUTE	PRODUCT
735.0716	17"	7/16	Drill Bit 7/16



Caleb Mende  
Certified Arborist  
Red Squirrel Tree Care



# earth anchors

## DUCKBILL Earth Anchor Model 40 DTS Kit



### SPECS + FEATURES

- Kit Contains (all pre-assembled):
  - 3 - Model 40 DUCKBILL Anchors
  - 3 - 12' of 1/16" high strength galvanized steel cables
  - 3 - tree collars
  - 3 - cable clamps
- Holds 300 lbs (135 kg) in normal soil
- Tree Diameter: 1-3"

SKU	SIZE	PRODUCT
10233	Kit	Anchor Model 40 DTS Kit
10228-II	Head & Cable	Anchor Model 40 DTS
10846 HEAD ONLY	Head Only	Anchor Model 40 DTS
003292	23" x 3/8"	Drive Rod



Scan for installation details and more information

## DUCKBILL Earth Anchor Model 68 DTS



### SPECS + FEATURES

- Kit Contains (all pre-assembled):
  - 3 - Model 68 DUCKBILL Anchors
  - 3 - 12' of 1/16" high strength galvanized steel cables
  - 3 - tree collars
  - 3 - cable clamps
- Holding capacity of 1,000 lbs
- Tree Diameter: 3-6"

SKU	SIZE	PRODUCT
10278	Head & Cable	Anchor Model 68
10847 HEAD ONLY	Head	Anchor Model 68
50009	36" x 1/2"	Drive Rod 68
50077 HEAVY DUTY	36" x 1/2" HD	Drive Rod, Heavy Duty 68



## DUCKBILL Earth Anchor Model 88 DTS



### SPECS + FEATURES

- Kit Contents:
  - (3) DUCKBILL anchors with 15 ft of wire rope per anchor attached
  - (3) Tree collars
  - (6) 3/16" wire rope clamps
- Tree Diameter: 6" - 11"
- Holding capacity of 3,000 lbs

SKU	SIZE	PRODUCT
10305	Head & Cable	Model 88 II 3000 lb
50012	48" x 3/4"	Drive Rod 88



## DUCKBILL Earth Anchor Model 138



The 138 is the largest of the **DUCKBILL** anchors. The anchor is cabled with a 5/16 inch (7.9 mm) cable. This anchor is installed with a small jackhammer and a power drive steel required.

### SPECS + FEATURES

- Anchor holding capacity will vary in different soils. Anchors are rated in an average (class 5) soil condition.
- Extra large anchor comes a 5/16" galvanized cable
- Drive rods are not included however they are required for installation.
- Holding capacity of 5,000 lbs.
- Tree Diameter: 11" >

SKU	SIZE	PRODUCT
10110	Head & Cable	Model 138 5000 lb



# earth anchors

CABLING + BRACING / EARTH ANCHORS

## Forged Eye & Eye Turnbuckles

**Forged Eye & Eye Turnbuckles** meet the performance requirements of ASTM Specification F1145-05 and Federal Specifications FF-T-791B- Type 1, Form 1, Class 4 and have a safety design factor of 5 to 1. Made from Drop-forged Carbon Steel for durability and Hot Dip Galvanized to ASTM A-153 for corrosion and weather resistance. Turnbuckle eyes are elongated, maximizing ease of attachment and minimizing stress. Recommended for in-line or straight pull applications only.

### SPECS + FEATURES

- 1/4: WLL 500 lbs
- 5/16: WLL 800 lbs
- 3/8: WLL 1200 lbs
- 1/2: WLL 2200 lbs

SKU	SIZE	ATTRIBUTE	PRODUCT
9EE250X04	1/4	4"	Turnbuckle Forged 1/4
9EE312X04	5/16	4.5"	Turnbuckle Forged 5/16
9EE375X06	3/8	6"	Turnbuckle Forged 3/8
9EE500X06	1/2	6"	Turnbuckle Forged 1/2
9EE500X09	1/2	9"	Turnbuckle Forged 1/2
9EE500X12	1/2	12"	Turnbuckle Forged 1/2



## Cable Clamp

### SPECS + FEATURES

- Cable clamp are also called Wire Rope Clips
- Galvanized steel
- Use 3 cable clamps at each connection to give maximum strength

SKU	SIZE	ATTRIBUTE	PRODUCT
EVA515-1E		1/8	Cable Clamp
WRC03G		3/16	Cable Clamp
WRC04G		1/4	Cable Clamp
WRC06G		3/8	Cable Clamp









 <b>3M</b> Hardware, PPE, Accessories	 <b>GATES</b> Belts	 <b>POULAN PRO</b> POULAN/WEEDEATER Replacement Parts
 <b>ALL GEAR</b> Accessories	 <b>GIBBS</b> Hardware	 <b>RAPCO</b> Carbide Chain
 <b>ARBORMASTER</b> Arborist Training & Education	 <b>HOFFCO-COMET</b> Belts & Clutches	 <b>RAZORMAX</b> Brush Blades
 <b>ARBORTEC</b> Clothing & Accessories	 <b>HUSQVARNA</b> Electrolux/AYP	 <b>ROCK EXOTICA</b> Hardware
 <b>ARBORWEAR</b> Hi-Vee Clothing	 <b>INTERLUBE</b> Opti Oil & Additives	 <b>SAMSON</b> Rope and Rope Accessories
 <b>ARBPRO</b> Clothing & Accessories	 <b>ISC</b> Hardware and Rigging	 <b>SEAFOAM</b> Motor Treatment
 <b>ARS</b> Cutting Tools	 <b>JAMESON</b> Poles & Cutting Heads	 <b>SENA</b> Bluetooth Headsets
 <b>ART</b> Hardware	 <b>JUNGLE JIM ACCESSORIES</b> OPE Accessories	 <b>SENDEC</b> Meters
 <b>@HEIGHT</b> Hardware	 <b>KASK</b> Helmets	 <b>SILKY</b> Cutting Tools and Parts
 <b>B3C FUEL SOLUTIONS</b> Fuel Treatment	 <b>KONG</b> Hardware	 <b>SPECTRUM</b> 2-Cycle & 4-Cycle Oil
 <b>BAHCO</b> Pruning Tools	 <b>KAWASAKI</b> 4-Cycle Engine Parts	 <b>SPENCER TAPE</b> Measuring Tools
 <b>BOSCH</b> Spark Plugs	 <b>KOHLER</b> Engines & Parts	 <b>SPYDER MFG</b> Hardware and Climbing
 <b>BRIGGS &amp; STRATTON</b> Engine Parts	 <b>LAUSON</b> LCT-Liquid Cooled Technology	 <b>STARBRITE</b> StarTron Fuel Treatment
 <b>BUCKINGHAM</b> Saddles, Rope Bags, Utility	 <b>LUCAS OIL</b> Oils, Lubricants, Cleansers & Protectants	 <b>STERLING ROPE</b> Rope
 <b>CAMP</b> Harnesses and Accessories	 <b>MAASDAM POW'R PULL</b> Rigging	 <b>SUBARU POWER</b> OEM Replacement Parts
 <b>CARLISLE</b> Tires, Tubes & Wheels	 <b>MARTIN WHEEL</b> Tires and Wheel Assemblies	 <b>TANAKA</b> Equipment Parts
 <b>CHAMPION</b> Spark Plugs	 <b>MARUYAMA</b> Outdoor Power Equipment	 <b>TECUMSEH</b> Engines & Parts
 <b>CLOGGER</b> Clothing & Accessories	 <b>MAX-TORQUE</b> Clutches	 <b>TEUFELBERGER</b> Rope
 <b>CMi</b> Hardware	 <b>MTD</b> OEM Equipment Parts	 <b>TILLOTSON</b> Carburetors, Kits & Parts
 <b>DMM</b> Hardware	 <b>NEW TRIBE</b> Harnesses and Accessories	 <b>TRUFUEL</b> Gasoline & Oil Premix
 <b>EDELRID</b> Harnesses and Accessories	 <b>NGK</b> Spark Plugs	 <b>US RIGGING</b> Hardware and Rigging
 <b>EFCO</b> Outdoor Power Equipment	 <b>NORAM</b> Clutches	 <b>VERI</b> Trimmer Heads
 <b>ELK RIVER</b> Harnesses and Accessories	 <b>OREGON</b> Chain, Bars and PPE	 <b>VP FUEL</b> Premix Fuels & Treatments
 <b>ELVEX / DELTA PLUS</b> Safety Products	 <b>PARTNER</b> Construction Products	 <b>WALBRO</b> Carburetors, Kits & Parts
 <b>ERIN ROPE</b> Throw Line	 <b>PELICAN ROPE WORKS</b> Ropes & Rigging	 <b>WEAVER LEATHER</b> Saddles and Rope Bags
 <b>EZ REACHER</b> EZ Reacher & Accessories	 <b>PEERLESS GEAR</b> Transmission, Drives & Parts	 <b>XTREME</b> Clutches
 <b>FANNO</b> Cutting Tools	 <b>PFERD INC.</b> Filing/Grinding & Sharpening	 <b>YALE CORDAGE</b> Rope
 <b>FLUID FILM</b> Lubricant, Penetrant & Preventative	 <b>PIX</b> Lawn & Garden Belts	 <b>ZAMA</b> Carburetors, Kits & Parts
 <b>FRED MARVIN</b> Cutting Tools	 <b>PORTABLE WINCH</b> Capstan Winches & Accessories	

\* Not available in Florida